

# Professional Quality



## ALYCO



Catalogue Price List

# 2017

# Welcome to the new ALYCOTOOLS 2017 catalogue

105  
years  
años  
urte

1912-2017

professional quality tools



#### EXPERIENCE

More than 105 years in purchase of raw material, manufacture and sales of forging products and hand tools.

#### PEOPLE

Work and experience focused on customer satisfaction, product and process innovation.

#### COMMITMENT

With work force, suppliers, customers and social environment.



#### CATALOGUE

Complete catalogue of professional tools for different markets prioritizing quality, performance and ergonomics.

#### INNOVATION

Continuous innovation of products and processes, adapting to the needs of the client.

#### CUSTOMER SATISFACTION

Commitment of satisfaction in information, quality of the products and fulfillment of the delivery terms.



# GRAPHIC INDEX

## TOOL SETS pages 8-19



## TOOL STORAGE pages 20-45



## PLIERS AND PINCERS pages 46-71



## SPANNERS AND WRENCHES pages 72-97



## KEYS pages 98-107



## SCREWDRIVERS AND BITS pages 108-127



## SOCKETS pages 128-155





# NEW ITEMS 2017



Reinforced roller cabinet



Magnetic tray



Tool trolley



Workshop set



Metallic box



Metallic modular trolley



Plastic tool box



Organiser



Contractors bag



Insulated wire cutter



Wire cutter



Nylon bag



Automatic wire stripper



Optical fiber wire stripper



Insulated cable knife



Torque wrench with display



Insulated wrench



Insulated ratchet wrench



Adjustable wrench large open mouth



Colour Hex key set



Insulated T handle



1/4 inch Bit set



3/8 inch Bit set



Insulated screwdriver



Insulated socket handle



Insulated precision screwdriver



1/2 inch XZN / RIBE insert bit socket



Interchangeable screwdriver set



Digital multimeter



Voltage tester



Spark plug socket



1-1/2 inch Impact wrench



**Welders hammer**



**Stainless steel wire brush**



**Rotating handle pruning shears**



**Pruning shears**



**Telescopic garden shears**



**Plastic shovel**



**Half moon trowel**



**Garden shears**



**Pruning saw**



**Fork hoe**



**Reinforced pipe wrench**



**Strap wrench**



**Mini level**



**Laser level**



**Magnetic measuring tape**



**COB lamp**



**LED lamp**



**LED inspection lamp**



**COB LED pocket lamp**



**Head lamp**



**COB head lamp**



**Work light**



**LED hand lamp**



**CREE TORCH**



**Car inspection lamp**



**Booster cable**

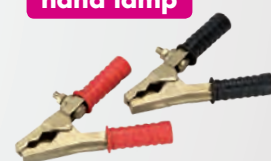

**Booster clamp**



**Magnetic pick-up tool**



**Mirror with light**



**Fish cable puller**



**Removal tool kit**



**Removal set**

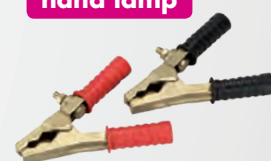

**Multiple puller**



**Filter wrench**



**Oil filter wrench**



**Hot melt glue applicator**



**High power mortar caulking tool**



**Grease gun**



**Grease transfer pump**



**Jerrycan**



**Oil can**

# QUALITY CERTIFICATES

## Renovated 07-2017



## COMMITMENT TO SERVICE



**SERVICE**

**100% RELIABLE**

**100% RAPIDE**



# PRICE LIST 2017

## Conditions of the price list



### PRICES

Recommended retail price. Taxes not included.



### SHIPPING

The freight charges corresponding to the shipments will be:

Paid by Alyco, in case of orders for a net amount of more than **500 Euros**,  
For shipments to Spain and Portugal (Iberia districts).

Paid by Alyco, in case of orders for a net amount of more than **900 Euros**,  
For shipments to the Balearic Islands.

Paid by Alyco, to case of orders for a net amount higher than **1200 Euros**,  
For shipments in the Canary Islands.

The rest of the shipments will be FOB.



### PAYMENT

**At 60 days** from the invoice date.



### VALIDITY OF THE PRICES

This price list cancels any previous edition.

Alyco reserves the right to modify the models without prior notice.

The specifications in this catalogue do not constitute a contractual commitment.

## Other sales conditions



### CHECKING OF THE SHIPMENT

For claims for product faults check that the packages are not opened when delivered.

Otherwise, advise the transport agency and state the incident and claim in less than 24 hours to Alyco.



### RETURN POLICY

Return shipments will be accepted in case of wrong shipments of defects due to Alyco within 30 days from date of shipment.



### WARRANTY

All items are guaranteed against defects in materials or workmanship.

This warranty exclusively covers changing or repairing the defect tools.



### DOWNLOAD OF THE PRICE FILE

You can download Excel file with code, description, price, barcode and catalog pages at **[www.alycotools.com/downloads](http://www.alycotools.com/downloads)**



## 01 Tool sets



Roller cabinet  
tool set

9



Chest  
tool set

13



Set tray

14



Tool box set

16



Bag  
set

17



Set box

18



Set in case

19

7 drawer roller cabinet with assorted tools



**Cabinet 192825**

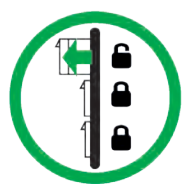
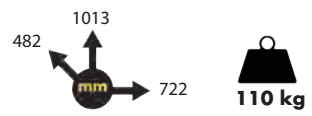

**ANTI OVERTURN SYSTEM**



Cabinet with accessories and options

**COMPLETE COMPOSITION**

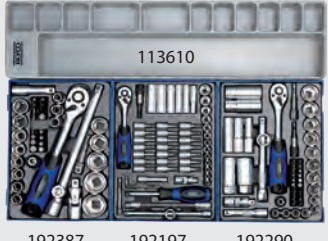

**BASIC COMPOSITION**

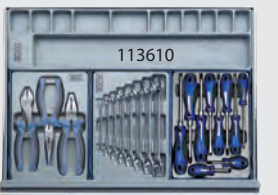

113612      192387 192197 101250      101210 191096 119090

| Code          | Description                           | No. of items | €               |
|---------------|---------------------------------------|--------------|-----------------|
| <b>192826</b> | <b>CABINET + COMPLETE COMPOSITION</b> | 253          | <b>1.680,80</b> |
| <b>192827</b> | <b>CABINET + BASIC COMPOSITION</b>    | 141          | <b>1.159,80</b> |

Features of cabinet in page 21 / accessories and options in page 24

## Wide cabinet with tools



Central lock

**Cabinet 192678**



Cabinet with accessories and options

### COMPLETE COMPOSITION



### BASIC COMPOSITION

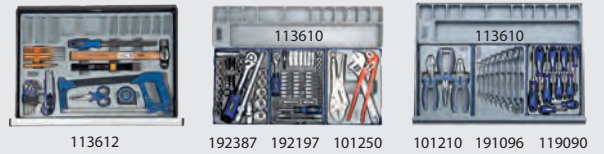

| Code          | Description                           | No. of items | €               |
|---------------|---------------------------------------|--------------|-----------------|
| <b>192679</b> | <b>CABINET + COMPLETE COMPOSITION</b> | 253          | <b>1.909,91</b> |
| <b>192680</b> | <b>CABINET + BASIC COMPOSITION</b>    | 141          | <b>1.371,00</b> |

Features of cabinet in page 22 / accessories and options in page 24

## 6 drawer cabinet with tools



Central lock

**Cabinet 192815**

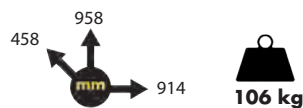

Cabinet with accessories and options

### COMPLETE COMPOSITION



### BASIC COMPOSITION



| Code          | Description                           | No. of items | €               |
|---------------|---------------------------------------|--------------|-----------------|
| <b>192816</b> | <b>CABINET + COMPLETE COMPOSITION</b> | 253          | <b>1.700,24</b> |
| <b>192817</b> | <b>CABINET + BASIC COMPOSITION</b>    | 139          | <b>1.161,34</b> |

Features of cabinet in page 22 / accessories and options in page 24

**7 drawer roller cabinet with assorted tools**



**Cabinet 192710**

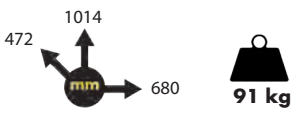

Central lock



Cabinet with accessories and options

**COMPLETE COMPOSITION**



192490 101210 101220



191096 191296 191196



119090 191480 101250

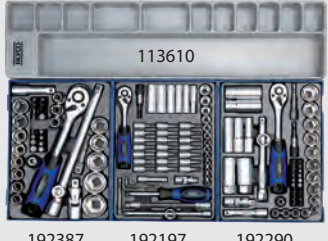

192387 192197 192290



113612

**BASIC COMPOSITION**



113612



192387 192197 101250

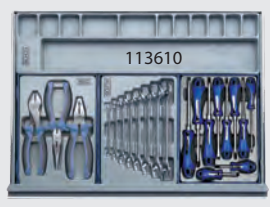

101210 191096 119090

| Code          | Description                           | No. of items | €               |
|---------------|---------------------------------------|--------------|-----------------|
| <b>192712</b> | <b>CABINET + COMPLETE COMPOSITION</b> | 253          | <b>1.646,58</b> |
| <b>192709</b> | <b>CABINET + BASIC COMPOSITION</b>    | 141          | <b>1.107,68</b> |

Features of cabinet in page 23 / accessories and options in page 24

## 3 drawer cabinet with tools



**Cabinet 192700**

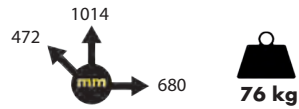

Central lock



Cabinet with accessories and options



192387 192197 101250

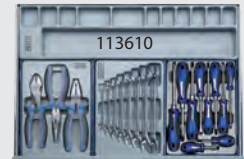

101210 191096 119090



113612

| Code          | No. of items | €             |
|---------------|--------------|---------------|
| <b>192702</b> | 141          | <b>983,46</b> |

Features of cabinet in page 23 / accessories and options in page 24

## 5 drawer cabinet with tools



**Cabinet 192785**

Cabinet supplied disassembled

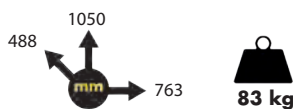

Central lock



192197 192387 191096



101210 119090



113612

| Code          | No. of items | €             |
|---------------|--------------|---------------|
| <b>192786</b> | 137          | <b>942,35</b> |

Features of cabinet in page 26 / accessories and options in page 24

**Light cabinet with tools**



**Cabinet 192780**

Cabinet supplied disassembled

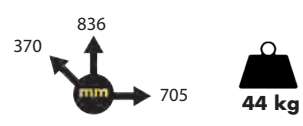

Central lock

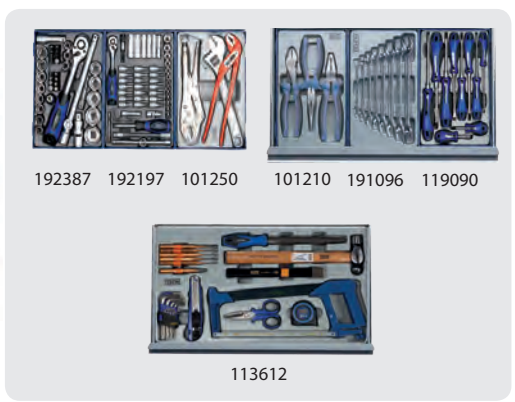

192387 192197 101250 101210 191096 119090



113612

| Code          | No. of items | €             |
|---------------|--------------|---------------|
| <b>192782</b> | 139          | <b>697,65</b> |

Features of cabinet in page 26

**6 drawer chest with tools**



**Chest 192720**



Central lock

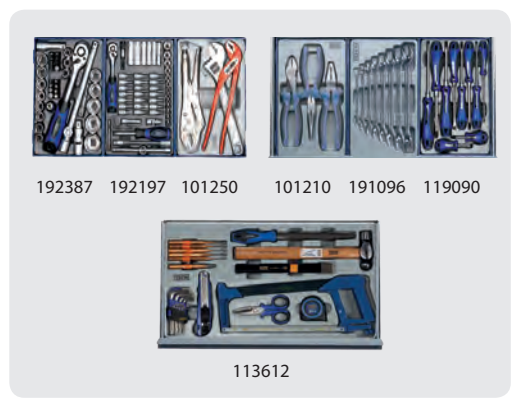

192387 192197 101250 101210 191096 119090



113612

| Code          | No. of items | €             |
|---------------|--------------|---------------|
| <b>192722</b> | 139          | <b>664,05</b> |

Features of chest in page 23

**3 drawer chest with tools**



**Chest 192718**

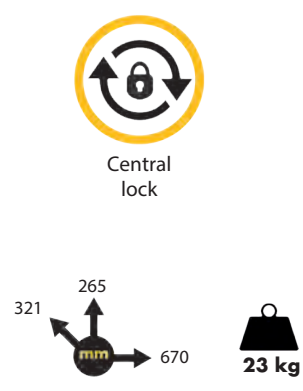

Central lock



101210 192197 119090

| Code          | No. of items | €             |
|---------------|--------------|---------------|
| <b>192719</b> | 67           | <b>300,58</b> |

Features of chest in page 33

## Modular system for tool storage



113612

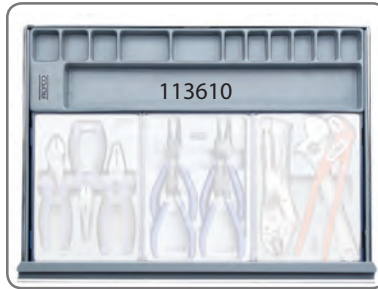

199002



199009

### CONTENTS 113612

- 1 ball pein hammer 30 mm
- 9 hex keys 1.5 to 10 mm
- 1 half-round file
- 1 flat chisel of 250 mm
- 5 pin punches 2, 3, 4, 5, 6 mm
- 1 center punch of 5 mm
- 1 tape measure of 3 m
- 1 knife 18 mm + 5 blades
- 1 pair of electrician's scissors
- 1 hacksaw

| Code          | Description                   | Dimensions mm | €             |
|---------------|-------------------------------|---------------|---------------|
| <b>113610</b> | <b>TRAY FOR CONSUMABLES</b>   | 560x140       | <b>5,83</b>   |
| <b>199002</b> | <b>EMPTY TRAY</b>             | 255x185x48    | <b>6,66</b>   |
| <b>199009</b> | <b>TOOLS MODULE</b>           | 255x185       | <b>3,39</b>   |
| <b>113612</b> | <b>TRAY FOR SPECIAL TOOLS</b> | 560x400x40    | <b>102,45</b> |

## Modular plastic tray with tools



### 1/2" DR. SOCKET SET

| Code          | No. of Items | €             |
|---------------|--------------|---------------|
| <b>192387</b> | 39           | <b>103,41</b> |

### CONTENTS 192387

- 1 Ratchet handle of 72 teeth
- 16 Sockets: 10 to 20, 22, 24, 27, 30, 32 mm
- 2 Extension bars: 75, 250 mm
- 1 Adapter 1/2" M x 3/8" F
- 1 Socket holder 1/2"
- 1 Universal joint
- 1 Adapter for 5/16" bits
- 16 5/16" bits: - Hex.: 8, 10, 12 mm
- Slotted: 8, 10, 12 mm - PH2, PH3, PH4
- PZ3, PZ4 - T40, T45, T50, T55, T60



### 1/4" DR. SOCKET SET

| Code          | No. of Items | €            |
|---------------|--------------|--------------|
| <b>192197</b> | 53           | <b>65,92</b> |

### CONTENTS 192197

- 1 Ratchet handle of 72 teeth
- 13 Sockets: 4 to 14 mm
- 6 Deep sockets: 6, 7, 8, 10, 12, 13 mm
- 2 Extension bars: 50, 150 mm
- 1 Screwdriver of 150 mm
- 1 Socket holder
- 1 Flexible extension bar of 150 mm
- 1 Universal joint / 1 adaptor 3/8" F x 1/4" M
- 1 Magnetic bit holder with lock ring for 1/4" bits
- 21 Insert bit sockets: - Hex.: 8, 10, 12 mm
- Slotted: 8, 10, 12 mm - PH2, PH3, PH4
- PZ3, PZ4 - T40, T45, T50, T55, T60
- 4 Hex keys: 1.27, 1.5, 2, 2.5 mm



### 3/8" DR. SOCKET SET

| Code          | No. of Items | €            |
|---------------|--------------|--------------|
| <b>192290</b> | 49           | <b>88,80</b> |

### CONTENTS 192290

- 1 Ratchet handle of 72 teeth
- 14 Sockets: 8-19, 21, 22 mm
- 5 Deep sockets: 8, 10, 13, 17, 19 mm
- 2 Spark plug sockets: 16, 21 mm
- 2 Extension bars: 75, 150 mm
- 1 Socket holder
- 1 Universal joint / 1 adaptor 3/8" M x 1/2" F
- 1 Magnetic bit holder with lock ring for 1/4" bits
- 1 Adapter for 1/4" bits
- 20 Bits - Hex: 3, 4, 5, 6, 7, 8 mm
- Slotted: 5.5, 7 mm - PH1, PH2, PH3
- PZ1, PZ2, PZ3 - T10, T15, T20, T25, T30, T40



### 1/4" + 1/2" DR. SOCKET SET

| Code          | No. of Items | €            |
|---------------|--------------|--------------|
| <b>192490</b> | 30           | <b>79,98</b> |

### CONTENTS 192490

- 8- 1/2" dr. female torx type socket: E10, E11, E12, E14, E16, E18, E20, E24
- 5- 1/4" dr. female torx type socket: E4, E5, E6, E7, E8
- 8- 1/2" dr. hexagonal insert bit sockets: 5, 6, 7, 8, 9, 10, 12, 14 mm
- 8- 1/2" dr. tamper torx type insert bit socket: T20, 25, 27, 30, 40, 45, 50, 55
- 1- 1/2" dr. torx type deep insert bit socket: T70

**Modular plastic case with tools**



See contents on page 49

**PLIERS SET**

| Code          | No. of Items | €            |
|---------------|--------------|--------------|
| <b>101210</b> | 3            | <b>38,90</b> |



See contents on page 54

**CIRCLIP PLIERS SET**

| Code          | No. of Items | €            |
|---------------|--------------|--------------|
| <b>101220</b> | 4            | <b>70,00</b> |



**LOCKING PLIERS+ ADJUSTABLE WRENCH SET**

| Code          | No. of Items | €            |
|---------------|--------------|--------------|
| <b>101250</b> | 3            | <b>51,64</b> |



See contents on page 74

**DOUBLE OPEN END SPANNERS SET**

| Code          | No. of Items | €            |
|---------------|--------------|--------------|
| <b>191096</b> | 8            | <b>43,90</b> |



See contents on page 77

**COMBINATION SPANNERS SET**

| Code          | No. of Items | €            |
|---------------|--------------|--------------|
| <b>191296</b> | 8            | <b>63,54</b> |



See contents on page 79

**DOUBLE BOX END SPANNERS SET**

| Code          | No. of Items | €            |
|---------------|--------------|--------------|
| <b>191196</b> | 7            | <b>65,18</b> |



See contents on page 87

**TUBULAR FORGED SOCKET WRENCH SET**

| Code          | No. of Items | €             |
|---------------|--------------|---------------|
| <b>191480</b> | 9            | <b>107,21</b> |



See contents on page 118

**SCREWDRIVERS SET**

| Code          | No. of Items | €            |
|---------------|--------------|--------------|
| <b>119090</b> | 10           | <b>40,47</b> |

## 5 tray metal tool box with 80 tools



**Toolbox 192735**

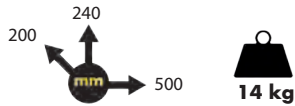

Provision for padlock



| Code          | No. of Items | €             |
|---------------|--------------|---------------|
| <b>192736</b> | 80           | <b>323,08</b> |

Features of box on page 34

## 3 tray metal tool box with 85 tools



**Toolbox 192731**

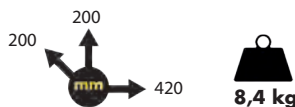

Provision for padlock



| Code          | No. of Items | €             |
|---------------|--------------|---------------|
| <b>192732</b> | 85           | <b>184,92</b> |

Features of box on page 34

**Nylon pouch with insulated tools**



**COMPOSITION INSULATED**

- |   |   |  |
|---|---|--|
| 1 101802<br>Combination pliers<br>180 mm                              | 1 101821<br>Diagonal cutting pliers<br>160 mm |  |
| 5 Screwdrivers  | 2 119311 (PH1x100)<br>119312 (PH2x100)        |  |
| 3 Slotted tip<br>119303 (3x100)<br>119304 (4x100)<br>119306 (6,5x150) |   |  |

**NON INSULATED**

- |                                    |                               |
|------------------------------------|-------------------------------|
| 1 108015 Electrician's<br>scissors | 1 108030 Electrician<br>knife |
|------------------------------------|-------------------------------|

| Code          | No. of Items | €            |
|---------------|--------------|--------------|
| <b>101410</b> | 9            | <b>89,03</b> |

**Nylon pouch with tools**



**COMPOSITION**

- |  |   |  |
|--|---|--|
| 1 101202<br>Combination pliers<br>180 mm | 1 110302<br>Diagonal cutting pliers<br>160 mm |  |
| 4 Screwdrivers                           | 2 119031 (PH1x100)<br>119029 (PH2x100)        |  |
| 1 Slotted tip<br>119005 (5,5x125)        | 1 Cabinet tip<br>119024 (4x100)               |  |
| 1 108015 Electrician's<br>scissors       | 1 108030<br>Electrician knife                 |  |

| Code          | No. of Items | €            |
|---------------|--------------|--------------|
| <b>101400</b> | 9            | <b>73,12</b> |

**Nylon pouch with tools**



**COMPOSITION**

- Scissors 108015
- Exchangeable screwdriver 119120
- Combination pliers 101202
- Light 27 led 190540

| Code          | No. of Items | €            |
|---------------|--------------|--------------|
| <b>101402</b> | 5            | <b>49,50</b> |

## Combined tool set in plastic case with 98 tools



**Extendible ratchet handles**  
1/2" and 1/4"



| Code          | €             |   |
|---------------|---------------|---|
| <b>101460</b> | <b>303,31</b> | 1 |

### COMPOSITION INSULATED

- |  |   |  |
|--|---|--|
| 101802<br>Combination pliers<br>180 mm                                   | 101821<br>Diagonal cutting pliers<br>160 mm |  |
| 5<br>Screwdriver   | 2<br>119311 (PH1x100)<br>119312 (PH2x100)   |  |
| 3<br>Slotted tip<br>119303 (3x100)<br>119304 (4x100)<br>119306 (6,5x150) |   |  |

#### Composition 1/2"

- |                                 |                                       |   |
|---------------------------------|---------------------------------------|---|
| 17<br>Sockets<br>10 to 32 mm    | 1<br>Extendible ratchet<br>1/2" 72 t. | 2<br>Extension bars<br>125, 250 mm      |
| 1<br>Universal joint            | 1<br>Adapter for bits<br>5/16"        | 2<br>Spark plug sockets<br>16 and 21 mm |
| 1<br>Adapter<br>3/8" F x 1/2" M |                                       |   |

#### Composition 1/4"

- |                                   |                                       |                               |
|-----------------------------------|---------------------------------------|-------------------------------|
| 13<br>Sockets<br>4 to 14 mm       | 1<br>Extendible ratchet<br>1/4" 72 t. | 1<br>Spinner handle<br>150 mm |
| 2<br>Extension bars<br>50, 150 mm | 1<br>Universal joint                  |                               |
| 1<br>Adapter<br>3/8" F x 1/4" M   |                                       |                               |

#### Composition

- |  |                                    |                               |
|--|------------------------------------|-------------------------------|
| 8<br>Open end spanners<br>6x7 to 20x22 | 9<br>193130<br>1.5 to 10 mm        | 1<br>109103<br>Locking pliers |
| 1<br>108015<br>Electrician's scissors  | 1<br>197315<br>Measure 5 m<br>Tape | 25<br>Bits 5/16"              |
| 1<br>196550<br>Hammer 455 gr           | 1<br>193369 Tester<br>1000 V       |                               |

## Combined tool set in plastic case with 98 tools



**Extendible ratchet handles**  
1/2" and 1/4"

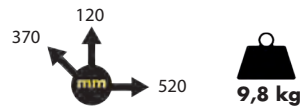

| Code          | €             |   |
|---------------|---------------|---|
| <b>101450</b> | <b>284,78</b> | 1 |

### COMPOSITION NON INSULATED

- |  |   |                                   |
|--|---|-----------------------------------|
| 101202<br>Combination pliers<br>180 mm | 110302<br>Diagonal cutting pliers<br>160 mm           |                                   |
| 5<br>Screwdrivers                      | 2<br>Slotted tip<br>119004 (4x80)<br>119006 (6,5x150) | 1<br>Cabinet tip<br>119023 (3x10) |
|  | 2<br>119031 (PH1x100)<br>119032 (PH2x150)             |                                   |

#### Composition 1/2"

- |                                 |                                       |   |
|---------------------------------|---------------------------------------|---|
| 17<br>Sockets<br>10 to 32 mm    | 1<br>Extendible ratchet<br>1/2" 72 t. | 2<br>Extension bars<br>125, 250 mm      |
| 1<br>Universal joint            | 1<br>Adapter for bits<br>5/16"        | 2<br>Spark plug sockets<br>16 and 21 mm |
| 1<br>Adapter<br>3/8" F x 1/2" M |                                       |   |

#### Composition 1/4"

- |                                   |                                       |                               |
|-----------------------------------|---------------------------------------|-------------------------------|
| 13<br>Sockets<br>4 to 14 mm       | 1<br>Extendible ratchet<br>1/4" 72 t. | 1<br>Spinner handle<br>150 mm |
| 2<br>Extension bars<br>50, 150 mm | 1<br>Universal joint                  |                               |
| 1<br>Adapter<br>3/8" F x 1/4" M   |                                       |                               |

#### Composition

- |  |                                    |                               |
|--|------------------------------------|-------------------------------|
| 8<br>Open end spanners<br>6x7 to 20x22 | 9<br>193130<br>1.5 to 10 mm        | 1<br>109103<br>Locking pliers |
| 1<br>108015<br>Electrician's scissors  | 1<br>197315<br>Measure 5 m<br>Tape | 25<br>Bits 5/16"              |
| 1<br>196550<br>Hammer 455 gr           | 1<br>193369 Tester<br>1000 V       |                               |

**Heavy duty aluminium case with tools**



Lock



Rear of pallet



**Case 198100**

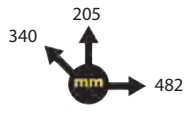

Case



Case + bag

| Code          | Description                     | No. of Items | €             |
|---------------|---------------------------------|--------------|---------------|
| <b>198101</b> | <b>CASE + COMPOSITION</b>       | 51           | <b>310,67</b> |
| <b>198106</b> | <b>CASE + BAG + COMPOSITION</b> | 52           | <b>365,27</b> |

Features of case 198100 on page 41 and bag 198154 on page 43

**Aluminium case with tools**



Lock



Rear of pallet



**Case 198110**

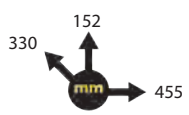

Case



Case + bag

| Code          | Description                     | No. of Items | €             |
|---------------|---------------------------------|--------------|---------------|
| <b>198111</b> | <b>CASE + COMPOSITION</b>       | 30           | <b>137,80</b> |
| <b>198116</b> | <b>CASE + BAG + COMPOSITION</b> | 31           | <b>195,53</b> |

Features of case 198110 on page 41 and bag 198154 on page 43



## 02 Storage



Roller cabinet

21



Magnetic tray

25



Modular storage

28



Fixed storage

30

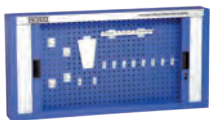

Wall board

32



Metal box

33



Metal trolley

36



Plastic box

38



Organiser

39



Aluminium case

41



Tool bag

42



Nylon bag

44



**Reinforced 7 drawer metal roller cabinet**

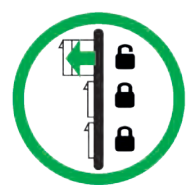

**ANTI OVERTURN SYSTEM**



Top Tray Stainless Steel

- Cabinet made of heavy-gauge steel sheet (1 mm. thick) with special antirust treatment.
- 2" wheels for bigger load and estability
- Brake on two casters. Two swivel casters.
- Locking of all drawers with central lock.
- Aluminium extrusion drawer pullers.
- Ball bearings on all slides of the drawers.

| DRAWERS   | Dimensions mm | Admissible weight Kg |
|-----------|---------------|----------------------|
| 5 drawers | 570x410x75    | <b>25</b>            |
| 2 drawers | 570x410x155   | <b>30</b>            |



After moving the cabinet, step on the brake

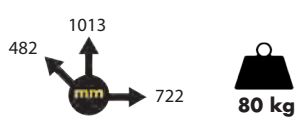

Central lock



Maximum load



Wheels Ø 5" x 2"



Reinforced handle



Metallic tray



Metal case



Paper roll support



Metalic trasher

| Code          | €             |          |
|---------------|---------------|----------|
| <b>192825</b> | <b>747,00</b> | <b>1</b> |

## Wide roller cabinet

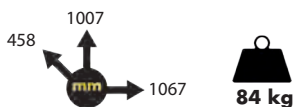

Cabinet with accessories



Central lock

**400 kg**

Maximum load



Wheels  
Ø 5" x 2"

- Cabinet made of heavy-gauge steel sheet (0,8 mm. thick) with special antirust treatment.
- Protective rubber mat on top and at bottom of drawers to protect surface against damage.
- Side storage space with 2 shelves.
- Metal brake on two casters. Two swivel casters.
- Locking of all drawers with central lock.
- Aluminium extrusion drawer pullers.
- Ball bearings on all slides of the drawers.



- After moving the cabinet, step on the brake
- Never open two drawers at the same time to avoid it toppling over.

| DRAWERS   | Dimensions mm | Admissible weight Kg |
|-----------|---------------|----------------------|
| 3 drawers | 570x410x75    | <b>20</b>            |
| 2 drawers | 570x410x155   | <b>30</b>            |
| 1 drawer  | 937x410x123   | <b>40</b>            |

| Code          | €             |          |
|---------------|---------------|----------|
| <b>192678</b> | <b>971,88</b> | <b>1</b> |

Accessories and options on page 24

## 6 drawer roller cabinet

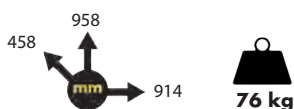

Cabinet with accessories



Central lock

**350 kg**

Maximum load



Wheels  
Ø 5" x 1,25"

- Cabinet made of heavy-gauge steel sheet (0,8 mm. thick) with special antirust treatment.
- Protective rubber mat on top and at bottom of drawers to protect surface against damage.
- Metal brake on two casters. Two swivel casters.
- Locking of all drawers with central lock.
- Aluminium extrusion drawer pullers.
- Ball bearings on all slides of the drawers.



- After moving the cabinet, step on the brake
- Never open two drawers at the same time to avoid it toppling over.

| DRAWERS   | Dimensions mm | Admissible weight Kg |
|-----------|---------------|----------------------|
| 3 drawers | 821x410x112   | <b>30</b>            |
| 2 drawers | 821x410x54    | <b>30</b>            |
| 1 drawer  | 821x410x170   | <b>35</b>            |

| Code          | €             |          |
|---------------|---------------|----------|
| <b>192815</b> | <b>762,22</b> | <b>1</b> |

Accessories and options on page 24

**7 drawer metal roller cabinet**

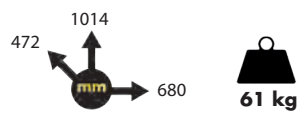

Central lock



**300 kg**

Maximum load



Wheels  
Ø 5" x 1,25"

- Cabinet made of heavy-gauge steel sheet 0,8 mm. thick) with special antirust treatment.
- Protective rubber mat on top and at bottom of drawers to protect surface against damage.
- Metal brake on two casters. Two swivel casters.
- Locking of all drawers with central lock.
- Aluminium extrusion drawer pullers.
- Ball bearings on all slides of the drawers.



- After moving the cabinet, step on the brake
- Never open two drawers at the same time to avoid it toppling over.



Cabinet with accessories

| DRAWERS   | Dimensions mm | Admissible weight Kg |
|-----------|---------------|----------------------|
| 5 drawers | 570x410x75    | <b>20</b>            |
| 2 drawers | 570x410x155   | <b>30</b>            |

| Code          | €             |          |
|---------------|---------------|----------|
| <b>192710</b> | <b>708,22</b> | <b>1</b> |

**Accessories and options on page 24**

**3 drawer roller cabinet**

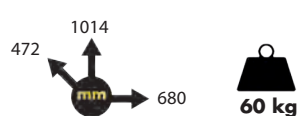

Cabinet with accessories



Central lock



**300 kg**

Maximum load



Wheels  
Ø 5" x 1,25"

- Same features as cabinet192710, except the lower compartment



- After moving the cabinet, step on the brake
- Never open two drawers at the same time to avoid it toppling over.

| DRAWERS      | Dimensions mm | Admissible weight Kg |
|--------------|---------------|----------------------|
| 2 drawers    | 570x410x75    | <b>20</b>            |
| 1 drawers    | 570x410x155   | <b>30</b>            |
| 1 lower trap | 680x472x395   | <b>40</b>            |

| Code          | €             |          |
|---------------|---------------|----------|
| <b>192700</b> | <b>566,79</b> | <b>1</b> |

**Accessories and options on page 24**

## Accessories



192678



192815



192710



192700



- Position 1 with screws
- Position 2 with screws
- Position 3 clip
- Position 4 metallic chip

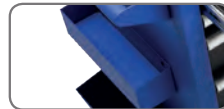

190601  
Position 3 or 4



190602  
Position 3 or 4



190603  
Position 2



190604  
Position 1

- Both sides are parts of the same set up
- The wastebasket in Position 3 cancels the Position 4
- The support for paper in Position 2 cancels the Position 3
- A metallic tray always is include in cabinet

| Code          | Description                 | €            |
|---------------|-----------------------------|--------------|
| <b>190601</b> | <b>METALLIC TRAY</b>        | <b>8,95</b>  |
| <b>190602</b> | <b>METALLIC WASTEBASKET</b> | <b>16,93</b> |
| <b>190603</b> | <b>PAPER ROLL SUPPORT</b>   | <b>12,23</b> |
| <b>190604</b> | <b>METALLIC HANDLE</b>      | <b>14,63</b> |

## Pack of metal drawer dividers



192699



192604

### POSSIBILITIES OF DIVIDERS

| Code   | For cabinet                        | Items                                     |
|--------|------------------------------------|---|
| 192699 | 192700 / 192710<br>192678 / 192635 | 4 sheets 565x40 mm<br>6 sheets 403x40 mm  |
| 192604 | 192815                             | 4 sheets 565x40 mm<br>9 sheet s 780x40 mm |

- Metal dividers of 1 mm thick sheet

| Code          | No. of Items | €            |
|---------------|--------------|--------------|
| <b>192699</b> | 10           | <b>21,01</b> |
| <b>192604</b> | 13           | <b>26,26</b> |

## Spare part for cabinets



190620



190621



190622



190623



190610



190615

- WHEELS**
- Polyurethane rubber with needle bearings
  - Wheels swivel with brake
  - Compatibles for cabinets 192700, 192710, 192815, 192678, 192635

- BEARINGS**
- A pair of guides provided (right and left)

- LOCK**
- Lock + two keys provided

| Code          | Description              | Dimensions mm | €            |
|---------------|--------------------------|---------------|--------------|
| <b>190620</b> | <b>FIXED WHEEL</b>       | Ø 125x30      | <b>10,92</b> |
| <b>190621</b> | <b>SWIVEL WHEEL</b>      | Ø 125x30      | <b>17,06</b> |
| <b>190622</b> | <b>FIXED RE. WHEEL</b>   | Ø 125x50      | <b>20,46</b> |
| <b>190623</b> | <b>SWIVEL WHEEL RE.</b>  | Ø 125x50      | <b>27,74</b> |
| <b>190610</b> | <b>METALLIC BEARINGS</b> | 400x45        | <b>10,70</b> |
| <b>190615</b> | <b>LOCK + KEY</b>        | ---           | <b>5,35</b>  |



**Rectangular magnetic tray**

STAINLESS  
STEEL



Display in blister



- Depth of tray 28 cm.
- 2 Magnetic bases Ø 80 mm.
- PVC base to prevent scratching

| Code          | Dimensions mm | €           |   |
|---------------|---------------|-------------|---|
| <b>121510</b> | 237 x 163     | <b>7,90</b> | 1 |

**Round magnetic tray**

STAINLESS  
STEEL



- Depth of tray 25 cm.
- Ø 80 mm magnet
- PVC base to prevent scratching

| Code          | Ø mm | €           |   |
|---------------|------|-------------|---|
| <b>121500</b> | 150  | <b>4,00</b> | 1 |

Display in blister

**Magnetic holder**



- With hole at each end for fastening
- Screws included
- To organize, hold and exhibit all types of tools



Accessory to attach supports Magnetic (included 2 in 121518)



| Code          | L mm | L " | Load kg | €           |   |
|---------------|------|-----|---------|-------------|---|
| <b>121518</b> | 450  | 18  | 13      | <b>8,30</b> | 1 |
| <b>121524</b> | 600  | 24  | 17      | <b>9,90</b> | 1 |

Display in blister

## 5 drawer roller cabinet



Central lock

**180 kg**

Maximum load



Wheels Ø 5" x 2"

- Opening and closing of upper part with a gas struts system
- Central locking of drawers and hatch
- All drawers slide on ball bearings
- Handle and side tray for tools
- Holes on both sides for tool placement
- Four swivel casters. Two with brake
- Safe closing system. When the hatch is open the drawers cannot be opened
- Aluminium extrusion drawer pullers

### DIMENSIONS AND ADMISSIBLE WEIGHT

|               | Dimensions mm | Admissible weight Kg |
|---------------|---------------|----------------------|
| Top surface   | 760x485x125   | 50                   |
| 2 drawers     | 450x295x62    | 10                   |
| 1 drawer      | 625x450x80    | 20                   |
| 1 drawer      | 450x295x127   | 20                   |
| 1 drawer      | 625x450x127   | 20                   |
| Lower surface | 760x485x345   | 50                   |



| Code          | €             |   |
|---------------|---------------|---|
| <b>192785</b> | <b>651,31</b> | 1 |

**Delivery disassembled**

## Light tool cart



Central lock

**150 kg**

Maximum load



Wheels Ø 4" x 1"

- Sliding tops.
- Lock on drawers and work top.
- Drawers slide on ball bearings.
- Two fixed casters and two swivel casters.
- Side handle.

### DIMENSIONS AND ADMISSIBLE WEIGHT

|               | Dimensions mm | Admissible weight Kg |
|---------------|---------------|----------------------|
| Top surface   | 700x365x170   | 35                   |
| 2 draws       | 587x325x60    | 10                   |
| Lower surface | 700x365x85    | 35                   |



| Code          | €             |   |
|---------------|---------------|---|
| <b>192780</b> | <b>280,99</b> | 1 |

**Delivery disassembled**



**Reinforced workshop trolley**



**200 kg**

Maximum load



Wheels  
Ø 4" x 1"

- Reinforced structure
- Two rotating wheels and two fixed wheels
- Reinforced side handle

| Code          | €             |   |
|---------------|---------------|---|
| <b>192832</b> | <b>192,60</b> | 1 |

**Delivery disassembled**

**One-drawer light tool trolley**



Central lock

**140 kg**

Maximum load



Wheels  
Ø 4" x 1"



- Drawer with ball bearings
- Two rotating wheels and two fixed wheels
- Reinforced side handle

| Code          | €             |   |
|---------------|---------------|---|
| <b>192727</b> | <b>197,10</b> | 1 |

**Delivery disassembled**

**Light trolley with 3 trays**

**100 kg**

Maximum load



Wheels  
Ø 4" x 1"



- Handle for easy carriage handling
- Two rotating wheels and two fixed wheels

| Code          | €             |   |
|---------------|---------------|---|
| <b>192725</b> | <b>103,08</b> | 1 |

**Delivery disassembled**

Modular storage set 4 modules

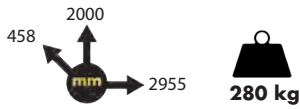

| Code   | Base material   | €        |
|--------|-----------------|----------|
| 192842 | WOOD            | 2.395,00 |
| 192843 | STAINLESS STEEL | 2.477,00 |



### HIGH LOCKER



- With locking system
- Includes 4 metal shelves

### CABINET WITH 5 DRAWERS



- Ball bearings guides
- Central lock

### LOCKER WITH 2 DOORS

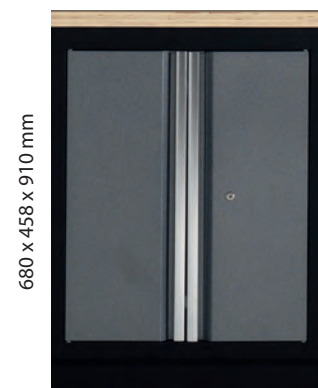

- Includes inner metal shelf
- Locking system



**Modular storage set 3 modules**

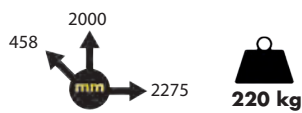

| Code          | Base material          | €               |
|---------------|------------------------|-----------------|
| <b>192844</b> | <b>WOOD</b>            | <b>1.677,00</b> |
| <b>192845</b> | <b>STAINLESS STEEL</b> | <b>1.728,00</b> |



**MULTIFUNCTION LOCKER**

680 x 458 x 910 mm

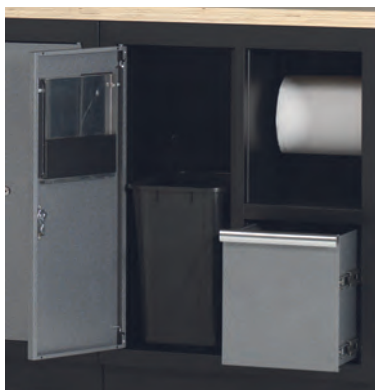

- Includes plastic waste bin
- Metallic support for paper roll

**TOP LOCKER**

680 x 281 x 350 mm



- Gas Spring struts

**ACCESSORIES NOT INCLUDED**

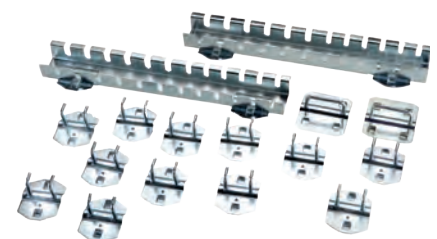

**HOOKS** Code 113489 See page. 31

## Workbench with two drawers



Lock  
In 2 drawers

**500 kg**

Maximum  
load

### PANEL

- 1.2 mm sheet metal panel
- Worklight can be fitted. All the accessories for light installation included.
- Heavy duty square reinforcement for the back panel.
- Including 16 hooks for hanging tools on the panel

- Workbench made with 2.5 mm metal sheet
- Rubber mat protector on top of workbench included.
- Shelf underneath the bench
- Possible to anchor to floor
- Drawers with locking system
- Wrinkle paint finish with anti-rust coat



86 kg

### INCLUDED:



Rubber mat protector

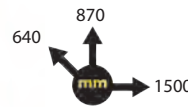

74 kg

| DRAWERS   | Dimensions mm | Admissible weight Kg |
|-----------|---------------|----------------------|
| 2 drawers | 446x420x100   | 25                   |

| Code   | Description             | €      |   |
|--------|-------------------------|--------|---|
| 192675 | WORKBENCH WITHOUT PANEL | 497,74 | 1 |
| 192676 | WORKBENCH WITH PANEL    | 624,38 | 1 |

Delivery disassembled

## Workbench with three drawers



Lock  
In 3 drawers

**500 kg**

Maximum  
load

| DRAWERS   | Dimensions mm | Admissible weight Kg |
|-----------|---------------|----------------------|
| 3 drawers | 430x450x145   | 25                   |

- Work surface made of 2,5 mm., metal sheet
- Shelf at the bottom of the workbench.
- Possible to anchor to floor.
- Three drawers. Each drawer with its own lock.



96 kg

| Code   | €      |   |
|--------|--------|---|
| 192677 | 652,35 | 1 |

Delivery disassembled

**5 drawer workbench**



| DRAWERS       | Dimensions mm | Admissible weight Kg |
|---------------|---------------|----------------------|
| 5 drawers     | 446x420x100   | 25                   |
| 2 inner trays | 450x440       | 50                   |



**250 kg**  
Maximum load

Tools not included

**PANEL 192642**  
 • Optional rear panel 1370x30x680 mm.  
 • Height with panel 1540 mm  
 • Supplied with 16 hooks Code 113489

• Worktop made of plywood. Thickness 38 mm.  
 • Height adjustable metal shelf for storing tools.  
 • Base reinforced with squares. Rubber ends fitted on bottom of legs.  
 • Height adjustable metal shelf for storing tools.

| Code   | Description             | €      |   |
|--------|-------------------------|--------|---|
| 192640 | WORKBENCH WITHOUT PANEL | 509,95 | 1 |
| 192641 | WORKBENCH WITH PANEL    | 610,33 | 1 |

Delivery disassembled

**2 drawer workbench**



| DRAWERS   | Dimensions mm | Admissible weight Kg |
|-----------|---------------|----------------------|
| 2 drawers | 446x420x100   | 25                   |



**250 kg**  
Maximum load

Tools not included

• Same features and measurements as workbench 192640 (except drawers)

| Code   | Description             | €      |   |
|--------|-------------------------|--------|---|
| 192645 | WORKBENCH WITHOUT PANEL | 406,86 | 1 |
| 192646 | WORKBENCH WITH PANEL    | 507,44 | 1 |

Delivery disassembled

**Pack of hooks for table**

For square panel of 12x12 mm

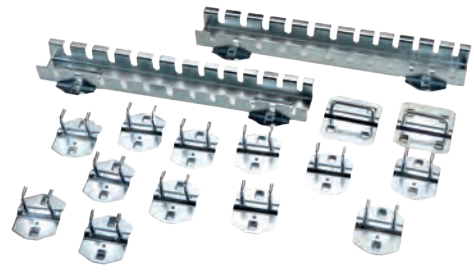

**CONTENTS**  
 12 double hooks  
 2 screwdrivers holders  
 2 hooks in V

| Code   | No. of Items | €     |
|--------|--------------|-------|
| 113489 | 16           | 22,17 |

For codes 192676, 192641, 192646

## Shutter cabinet

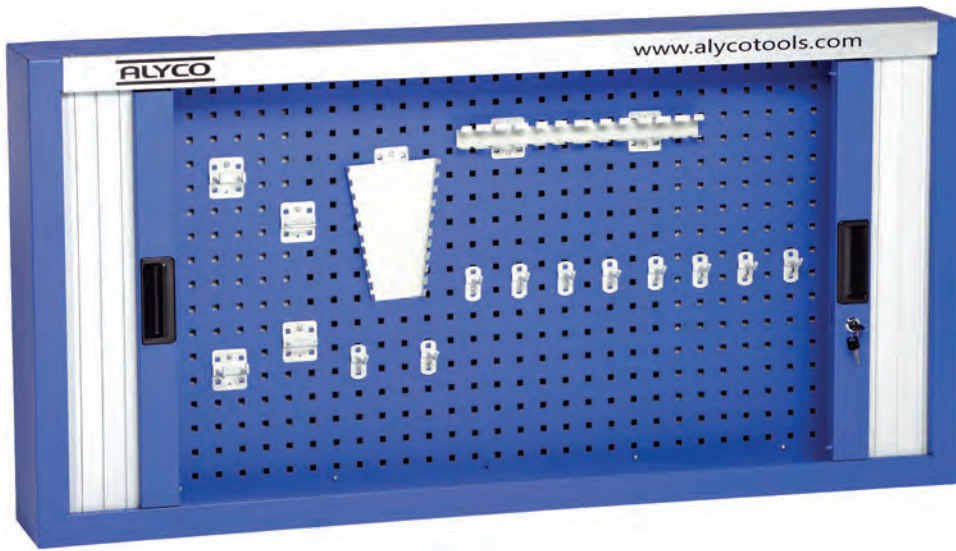

Lock

### INCLUDES:



Pack of 16 hooks **113499**

- Perforated panel of 1 mm.
- Panel holes 10x10 mm
- Lockable blind with key
- With holes in the rear part so to hang on the wall, and in the bottom to fix to work table

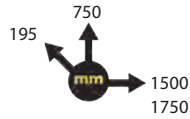

**38 kg**  
**44 kg**

| Code          | Dimensions mm | €             |
|---------------|---------------|---------------|
| <b>192802</b> | 1500x750x195  | <b>566,15</b> |
| <b>192804</b> | 1750x750x195  | <b>642,55</b> |

## Perforated panel

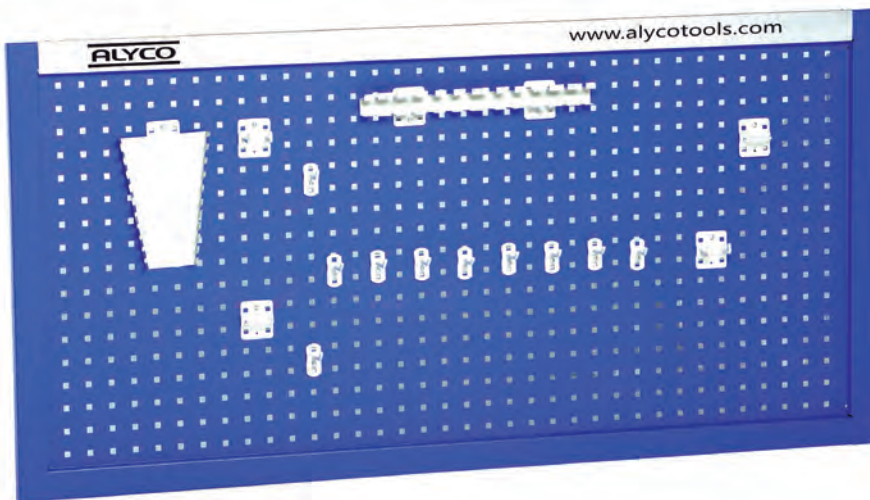

### INCLUDES:



Pack of 16 hooks **113499**

- Sheet 1 mm thick
- Holes in panel 10x10 mm
- Suitable for hanging on a wall

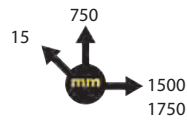

**11 kg**  
**13 kg**

| Code          | Dimensions mm | €             |
|---------------|---------------|---------------|
| <b>192806</b> | 1500x750x15   | <b>180,66</b> |
| <b>192808</b> | 1750x750x15   | <b>213,92</b> |

## Pack of hooks for panel

For square panel of 12x12 mm



### CONTENTS

- 10 singles hooks
- 2 doubles hooks
- 2 hooks V
- 1 bracket for keys
- 1 screwdriver holders

| Code          | No. of items | €            |
|---------------|--------------|--------------|
| <b>113499</b> | 16           | <b>24,13</b> |

For codes 192802, 192804, 192806, 192808

**6 drawer tool chest**



Central lock

**90 kg**

Maximum load



| DRAWERS           | Dimensions mm | Admissible weight Kg |
|-------------------|---------------|----------------------|
| 3 drawers         | 170x275x48    | <b>5</b>             |
| 2 drawers         | 570x275x48    | <b>8</b>             |
| 1 upper container | 570x275x75    | <b>12</b>            |

- Central single locking for all compartments
- Rubber math protector at bottom of drawers
- Heavy duty side handles



**19 kg**

| Code          | €             |   |
|---------------|---------------|---|
| <b>192720</b> | <b>247,40</b> | 1 |

**3 drawer metal chest**



Central lock

**35 kg**

Maximum load

| DRAWERS   | Dimensions mm | Admissible weight Kg |
|-----------|---------------|----------------------|
| 2 drawers | 570x275x48    | <b>8</b>             |
| 1 drawer  | 570x275x75    | <b>12</b>            |

- Rubber math protector at bottom of drawers
- Heavy duty side handles

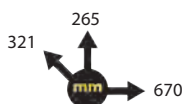

**14 kg**

| Code          | €             |   |
|---------------|---------------|---|
| <b>192718</b> | <b>155,02</b> | 1 |

**Construction trunk**



Padlock ready



**192792**



**8 kg**

**192793**



**17 kg**

- Sheet thickness: 192792 of 1 mm, 192793 of 1.2 mm.
- Wrinkle painted finish.
- Bigger metal trunk (192793) includes inner metal tray.

| Code          | Dimensions mm   | Weight kg | €             |
|---------------|-----------------|-----------|---------------|
| <b>192792</b> | 580 x 280 x 287 | 40        | <b>92,34</b>  |
| <b>192793</b> | 685 x 355 x 332 | 50        | <b>148,95</b> |

Tools not included

**Set of construction trunks**



**CONTENTS**  
**192792 + 192793**



**25 kg**

| Code          | Dimensions mm   | €             |
|---------------|-----------------|---------------|
| <b>192794</b> | 685 x 355 x 332 | <b>222,60</b> |

## Metal tool box with 5 trays

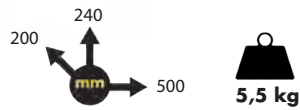

Padlock ready

**28 kg**

Maximum load



- Sheet thickness 0.6 mm.
- 4 trays of 500x95x50 mm
- 1 tray base of 500x200x125 mm
- Electrostatic two color painting, oven-dried
- Folding handles.

| Code          | €            |   |
|---------------|--------------|---|
| <b>192735</b> | <b>46,00</b> | 1 |

## Metal tool box with 3 trays

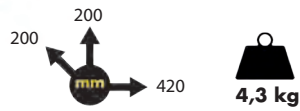

Padlock ready

**18 kg**

Maximum load



| Code          | €            |   |
|---------------|--------------|---|
| <b>192731</b> | <b>36,91</b> | 1 |

## Metal tool box with 1 tray

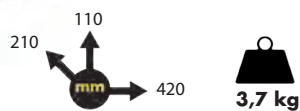

Padlock ready

**8 kg**

Maximum load

| Code          | €            |   |
|---------------|--------------|---|
| <b>192733</b> | <b>30,38</b> | 1 |



**Reinforced metallic box**



183352



Padlock ready



1,5 kg

**15 kg**

Maximum load



183354



Padlock ready



2 kg

**18 kg**

Maximum load



183356



Padlock ready



3,3 kg

**22 kg**

Maximum load



- Metal enclosure with plastic reinforcements
- 0.6 mm folded sheet
- Ergonomic mobile handle
- Metal locking lids
- Removable plastic tote tray
- Hinge with metal pin
- Shock Protectors

| Code          | Dimensions mm | €            |   |
|---------------|---------------|--------------|---|
| <b>183352</b> | 395x180x170   | <b>20,70</b> | 1 |
| <b>183354</b> | 470x238x203   | <b>29,66</b> | 1 |
| <b>183356</b> | 582x298x255   | <b>44,50</b> | 1 |

**Set of metal boxes**



**CONTENTS**  
183352 + 183354 + 183356



7,3 kg

| Code          | €            |   |
|---------------|--------------|---|
| <b>183350</b> | <b>83,80</b> | 1 |

## Reinforced modular metal trolley



Padlock ready

**50 kg**

Maximum load

Sheet thickness 0.8 mm

Ball bearing guides

Modules fixed by metal closures

5" Reinforced rubber wheels

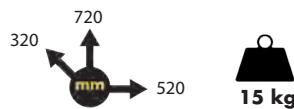

Extensible handle telescopic in aluminum



Reinforced aluminum handle



### DIMENSIONS

|               |                |
|---------------|----------------|
| 1 metal box   | 580x280x220 mm |
| 1 metal box   | 490x250x220 mm |
| 1 lower trunk | 430x250x430 mm |

| Code          | €             |   |
|---------------|---------------|---|
| <b>183310</b> | <b>188,00</b> | 1 |

## Modular metal trolley



Padlock ready

**50 kg**

Maximum load

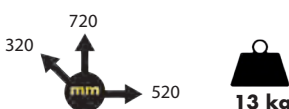

- Trolley comprising 3 modules
- 0.8 mm metal sheet
- Modules fixed by metal fastener lids
- Ball bearing guides
- Telescopic aluminum handle
- 5" rubber wheels

| Code          | €             |   |
|---------------|---------------|---|
| <b>183300</b> | <b>172,00</b> | 1 |

**Small modular plastic trolley**



**20 kg**  
Maximum load

Padlock ready



Tools not included

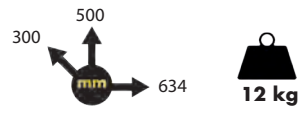

| DIMENSIONS    |                |
|---------------|----------------|
| 1 bottom case | 634x300x279 mm |
| 1 upper case  | 508x256x223 mm |

- Trolley made up of plastic tool storage case and plastic tool box with aluminium handle
- Both cases with inner plastic trays
- Tool box fixed to the plastic trolley by metal locking lids
- Plastic tool box with aluminium handle and transparent plastic organizer on the upper part
- Extendable telescopic handle
- Rubber wheels. Big size wheels for an easy handling

| Code          | €             |   |
|---------------|---------------|---|
| <b>192796</b> | <b>124,76</b> | 1 |

**Modular plastic trolley**



**20 kg**  
Maximum load

Padlock ready



- Modular trolley made in hard plastic for higher resistance
- Loading storage module + 3 drawers + plastic case with inner tray
- Can be knocked down in three different modules
- Extendable telescopic handle
- Large sized rubber wheels

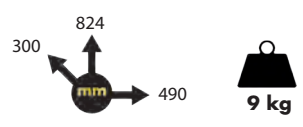

| Code          | €            |   |
|---------------|--------------|---|
| <b>192795</b> | <b>90,82</b> | 1 |

**4 in 1 plastic storage case**



- Upper plastic tote tray for tools.
- Bottom plastic case for tools.
- Plastic cover with storage compartment.
- Folding handle.
- Loading storage compartment of high capacity.
- Rubber wheels for easy transport.

| Code          | €            |   |
|---------------|--------------|---|
| <b>192759</b> | <b>75,06</b> | 1 |

Tools not included

Tools not included

### Pack of 4 cases with tote trays



192821



Padlock ready

**10 kg**

Maximum load



Tools not included



192822



Padlock ready

**8 kg**

Maximum load



Removables trays



192823



**5 kg**

Maximum load



192824



**3 kg**

Maximum load

Each box with:

- Inner plastic tote tray.
- Loading storage area. Two small plastic extractable cases fitted in the top of each case.
- Ergonomic plastic handle covered with non slip rubber

| Code          | Dimensions mm | €            |
|---------------|---------------|--------------|
| <b>192821</b> | 606x310x300   | <b>31,84</b> |
| <b>192822</b> | 508x250x240   | <b>22,84</b> |
| <b>192823</b> | 432x220x180   | <b>14,20</b> |
| <b>192824</b> | 355x180x140   | <b>8,19</b>  |

### Pack of 4 cases



#### CONTENTS

**192821 + 192822  
192823 + 192824**

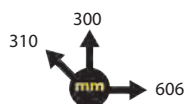

| Code          | €            |   |
|---------------|--------------|---|
| <b>192765</b> | <b>70,91</b> | 1 |



**Pack of 3 cases of plastic**

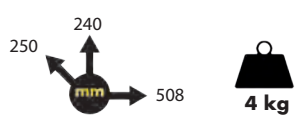

**CONTENTS**  
192822 + 192823 + 192824

| Code          | €            |   |
|---------------|--------------|---|
| <b>192829</b> | <b>39,90</b> | 1 |

**Reinforced plastic box**

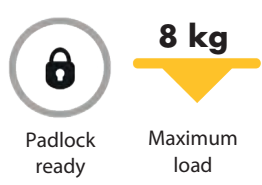

- Ergonomic aluminum mobile handle
- Metal locking lids
- Removable plastic tote tray
- Hinge with metal pin
- Shock Protectors on corners

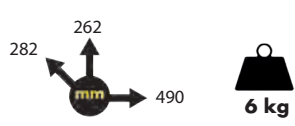

| Code          | €            |   |
|---------------|--------------|---|
| <b>183370</b> | <b>33,00</b> | 1 |

**Case for consumables**



Up to 7 boxes can be piled up

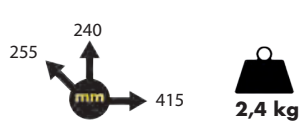

- 4 drawers with 4 compartments each
- Top compartment with plastic lid
- Plastic handle

| Code          | €            |   |
|---------------|--------------|---|
| <b>183360</b> | <b>30,40</b> | 6 |



## Plastic organisers



192763



Special design of the cover that keeps fixed the inner cases when the cover is closed



192762

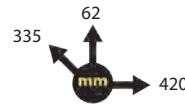

192760

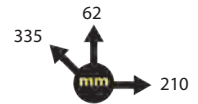

- Ergonomic bimaterial handle.
- Double side locking of the plastic case.

| Code          | Compartments | €            |   |
|---------------|--------------|--------------|---|
| <b>192763</b> | 8            | <b>21,93</b> | 5 |
| <b>192762</b> | 19           | <b>16,87</b> | 5 |
| <b>192760</b> | 15           | <b>8,51</b>  | 5 |

Consumables not included

## Double side plastic case organisers



Consumables not included



- Double tray plastic case with multiple divisions on each tray.
- Inner lay-out of the plastic case can be modified moving the inner plastic divisions.
- With individual locking for each cover.
- Polycarbonate transparent covers.

| Code          | Dimensions mm | €            |   |
|---------------|---------------|--------------|---|
| <b>192766</b> | 320x260x80    | <b>9,88</b>  | 5 |
| <b>192768</b> | 380x290x80    | <b>12,72</b> | 5 |

**Heavy duty aluminium case**



Central lock

**20 kg**

Maximum load



**6 kg**

Extendable handle



Case

Case + bag  
198154



| Code          | Description       | Dimensions mm | €             |
|---------------|-------------------|---------------|---------------|
| <b>198100</b> | <b>CASE</b>       | 482x340x205   | <b>146,87</b> |
| <b>198105</b> | <b>CASE + BAG</b> | 800x340x205   | <b>201,47</b> |

**Aluminium case with 1 tool panel**



Central lock

**15 kg**

Maximum load

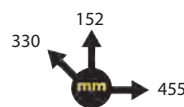

**3,8 kg**

Extendable handle



Case

Case + bag  
198154

- Panel for holding tools with straps and pockets
- Metal locking for holding the panel in vertical position
- Modular base (5 dividers)
- Extendable handle and wheels for easy transport (trolley)

| Code          | Description       | Dimensions mm | €             |
|---------------|-------------------|---------------|---------------|
| <b>198110</b> | <b>CASE</b>       | 455x330x152   | <b>68,43</b>  |
| <b>198115</b> | <b>CASE + BAG</b> | 770x330x152   | <b>123,03</b> |

## Nylon bag with metal handle



**45 kg**

Maximum load



Side specially designed for different shapes and small tools. Zip locking.



Side specially designed for big size tools (electrical tools, batteries, painting bottles, etc). Plastic covered document pocket. Zip locking.

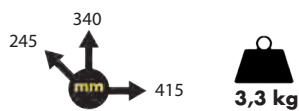

| Code          | €            |   |
|---------------|--------------|---|
| <b>198160</b> | <b>93,06</b> | 1 |

Tools not included

## Mobile tool bag



**25 kg**

Maximum load

Bag with top zip lockings

Inner part with many different pocket sizes



Reinforced base for keeping opened during work



Extensible aluminum handle

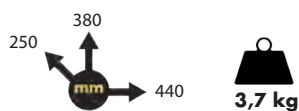

| Code          | €            |   |
|---------------|--------------|---|
| <b>198150</b> | <b>75,89</b> | 1 |

Tools not included

**Nylon backpack with inner panel**



**30 kg**

Maximum load

Bag with top zip lockings

Inner part with many and different pocket sizes



Reflective straps



| Code          | €            |   |
|---------------|--------------|---|
| <b>198152</b> | <b>78,84</b> | 1 |

Tools not included

**Nylon laptop and tools case**

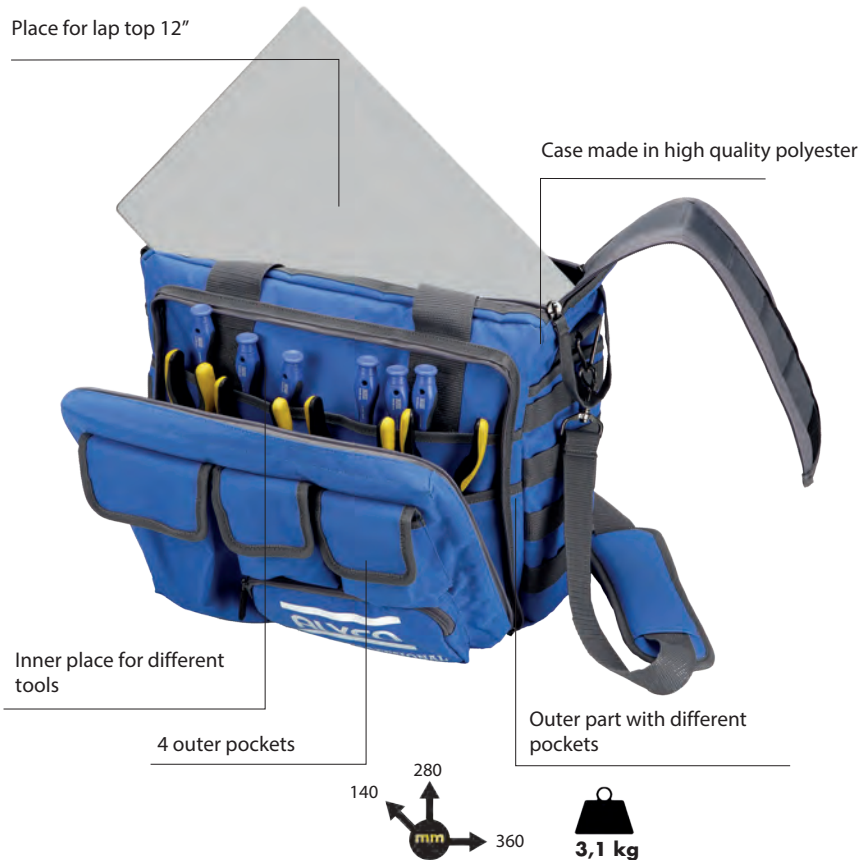

**30 kg**

Maximum load

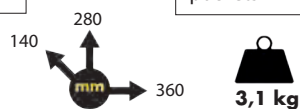

| Code          | €            |   |
|---------------|--------------|---|
| <b>198154</b> | <b>57,99</b> | 1 |

Tools not included

## Nylon bag



Possibility of adjusting to shoulder and waist

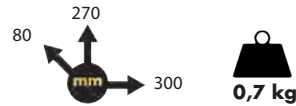

| Code   | €     |   |
|--------|-------|---|
| 196860 | 30,50 | 1 |

## Nylon belt bag



Possibility of fastening to the pocket or the belt

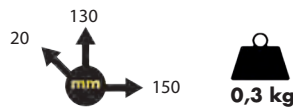

| Code   | €    |   |
|--------|------|---|
| 196850 | 9,10 | 1 |

## Nylon builders bag



- Nylon fabric with inner reinforcements
- Adjustable nylon belt
- Click shut buckle

| Code   | €     |   |
|--------|-------|---|
| 196872 | 22,20 | 1 |

**Nylon bag for power tool**



- Adjustable nylon fastening strap
- Quick-release buckle for securing of the power tool

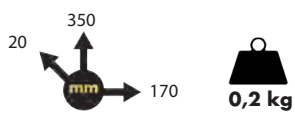

| Code          | €            |   |
|---------------|--------------|---|
| <b>196852</b> | <b>11,30</b> | 1 |

**Nylon bag**



196880



196882

- Made of nylon with internal reinforcements
- Adjustable nylon belt
- Click shut buckle

| Code          | Dimensions mm | €            |
|---------------|---------------|--------------|
| <b>196880</b> | 240x240x55    | <b>13,18</b> |
| <b>196882</b> | 170x240x55    | <b>11,68</b> |

**Individual nylon bag**



Possibility of securing to pocket and belt

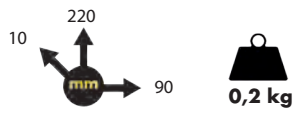

| Code          | €           |   |
|---------------|-------------|---|
| <b>196848</b> | <b>4,50</b> | 1 |



## 03 Pliers and cutters



Heavy-duty combination pliers 47



Combination pliers 48



Cutting pliers 49



Water pump pliers 50



Insulated pliers 51



Circlip pliers 54



Locking pliers 55



Mini pliers 56



Pincers 58



Bolt cutters 60



Wire cutters 61



Wire strippers 62



Crimping pliers 64



Scissors 66



Knives 68



Aviation snips 70

**Combination pliers**

DIN 5746

High leverage

Cr-V STEEL

**CUTTING TABLE**

|   | Ø mm                         |
|---|------------------------------|
|   | 101206/<br>101208/<br>101209 |
| ○ | 4/5/6                        |
| ◐ | 2,8/3,5/4                    |
| ◑ | 1,8/2,4/2,8                  |
| ● | 1,6/2/2,4                    |

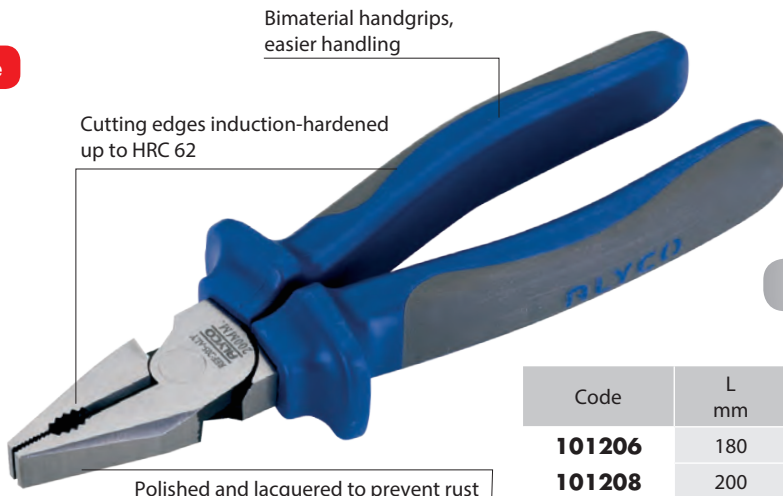

Bimaternal handgrips, easier handling

Cutting edges induction-hardened up to HRC 62

Polished and lacquered to prevent rust

45% LESS EFFORT

| Code   | L mm | L " | €     |   |
|--------|------|-----|-------|---|
| 101206 | 180  | 7   | 17,42 | 6 |
| 101208 | 200  | 8   | 19,99 | 5 |
| 101209 | 225  | 9   | 21,62 | 5 |

Display with hanger

**HIGH LEVERAGE PRINCIPLE**

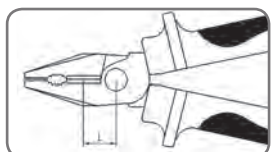

Less distance between rotation axis and cutting edge because of eccentric joining of the rivet.

Lesser effort, up to 45%, both in cutting and handling operations (Holding, folding, tightening).

**COMBINATION PLIERS**

| L | High Leverage | Standard |
|---|---------------|----------|
|   | 14            | 20       |

**Cutting pliers**

DIN 5749

High leverage

Cr-V STEEL



**CUTTING TABLE**

| Wire | Ø mm             |
|------|------------------|
|      | 110304<br>110305 |
| ○    | 4                |
| ◐    | 3                |
| ◑    | 2                |
| ●    | 1,6              |

| Code   | L mm | L " | €     |   |
|--------|------|-----|-------|---|
| 110304 | 160  | 6   | 17,06 | 6 |
| 110305 | 180  | 7   | 19,01 | 5 |

Display with hanger

**Diagonal cutting pliers**

DIN 5749

High leverage

Cr-V STEEL



**CUTTING TABLE**

| Wire | Ø mm   |
|------|--------|
|      | 101312 |
| ○    | 5      |
| ◐    | 3,5    |
| ◑    | 2,4    |
| ●    | 2      |

| Code   | L mm | L " | €     |   |
|--------|------|-----|-------|---|
| 101312 | 200  | 8   | 20,57 | 5 |

Display with hanger

**Long nose pliers**

DIN 5745

High leverage

Cr-V STEEL



| Code   | L mm | L " | €     |   |
|--------|------|-----|-------|---|
| 101303 | 160  | 6   | 16,16 | 6 |
| 101304 | 200  | 8   | 18,62 | 5 |

Display with hanger

CUTTING WIRE: ○ Soft / ◐ Semi-hard / ◑ Hard / ● Piano wire

## Combination pliers

DIN 5746

Cr-V STEEL



### CUTTING TABLE

|   | Ø mm                         |
|---|------------------------------|
|   | 101201/<br>101202/<br>101203 |
| ○ | 4/4/4                        |
| ◐ | 2,8/3/3                      |
| ◑ | 1,8/2/2                      |
| ● | 1,4/1,6/1,6                  |

- Hardened cutting edges
- Polished and lacquered finish (rust proof)
- Bimaterial and ergonomic handgrips

| Code          | L mm | L " | €            |   |
|---------------|------|-----|--------------|---|
| <b>101200</b> | 130  | 5   | <b>9,99</b>  | 6 |
| <b>101201</b> | 160  | 6   | <b>10,80</b> | 6 |
| <b>101202</b> | 180  | 7   | <b>12,04</b> | 6 |
| <b>101203</b> | 200  | 8   | <b>13,22</b> | 6 |

Display with hanger

## Long nose pliers

DIN 5745

Cr-V STEEL



| Code          | L mm | L " | €            |   |
|---------------|------|-----|--------------|---|
| <b>101300</b> | 140  | 5,5 | <b>10,70</b> | 6 |
| <b>101301</b> | 160  | 6   | <b>11,71</b> | 6 |
| <b>101302</b> | 200  | 8   | <b>13,50</b> | 6 |

Display with hanger

## Bent nose pliers

DIN 5745

Cr-V STEEL



| Code          | L mm | L " | €            |   |
|---------------|------|-----|--------------|---|
| <b>101310</b> | 200  | 8   | <b>14,56</b> | 6 |

Display with hanger

## Flat nose pliers

DIN 5745

Cr-V STEEL



| Code          | L mm | L " | €            |   |
|---------------|------|-----|--------------|---|
| <b>102201</b> | 160  | 6   | <b>11,42</b> | 6 |

Display with hanger

## Round nose pliers

DIN 5745

Cr-V STEEL



| Code          | L mm | L " | €            |   |
|---------------|------|-----|--------------|---|
| <b>104101</b> | 160  | 6   | <b>11,98</b> | 6 |

Display with hanger

## Wire stripping pliers

Cr-V STEEL



- With screw to adjust to wire diameter

| Code          | L mm | L " | €            |   |
|---------------|------|-----|--------------|---|
| <b>107101</b> | 160  | 6   | <b>17,28</b> | 6 |

Display with hanger

CUTTING WIRE: ○ Soft / ◐ Semi-hard / ◑ Hard / ● Piano wire

**Diagonal cutting pliers**

**DIN 5749**

**Cr-V STEEL**



| CUTTING TABLE |                  |
|---------------|------------------|
| Wire          | Ø mm             |
|               | 110302<br>110303 |
| ○             | <b>4</b>         |
| ◐             | <b>3</b>         |
| ◑             | <b>2</b>         |
| ●             | <b>1,6</b>       |

- Hardened cutting edges
- Polished and lacquered finish (rust proof)
- Bimaterial and ergonomic handgrips

| Code          | L mm | L " | €            |   |
|---------------|------|-----|--------------|---|
| <b>110301</b> | 130  | 5,5 | <b>10,64</b> | 6 |
| <b>110302</b> | 160  | 6   | <b>11,29</b> | 6 |
| <b>110303</b> | 180  | 8   | <b>12,26</b> | 6 |

Display with hanger

**Heavy duty diagonal cutting pliers**

**DIN 5749**

**Cr-V STEEL**



| CUTTING TABLE |                   |
|---------------|-------------------|
| Wire          | Ø mm              |
|               | 110310/<br>110311 |
| ○             | <b>5</b>          |
| ◐             | <b>3,5</b>        |
| ◑             | <b>2,4</b>        |
| ●             | <b>2</b>          |

| Code          | L mm | L " | €            |   |
|---------------|------|-----|--------------|---|
| <b>110309</b> | 160  | 6   | <b>12,16</b> | 6 |
| <b>110310</b> | 180  | 7   | <b>12,97</b> | 6 |
| <b>110311</b> | 200  | 8   | <b>14,52</b> | 6 |

Display with hanger

**Pliers set**

**Heavy-duty**



Dimensions of box: 255x185x48 mm

**CONTENTS** 101206 / 110305 / 101304

| Code          | No. of Items | €            |   |
|---------------|--------------|--------------|---|
| <b>101217</b> | 3            | <b>56,00</b> | 1 |

**End cutting pliers**

**DIN 5748**

**Cr-V STEEL**



| CUTTING TABLE |                   |
|---------------|-------------------|
| Wire          | Ø mm              |
|               | 111100<br>/111101 |
| ○             | <b>4/5</b>        |
| ◐             | <b>3/3,5</b>      |
| ◑             | <b>2/2,4</b>      |
| ●             | <b>1,6/2</b>      |

| Code          | L mm | L " | €            |   |
|---------------|------|-----|--------------|---|
| <b>111100</b> | 160  | 6   | <b>13,50</b> | 6 |
| <b>111101</b> | 200  | 8   | <b>16,22</b> | 6 |

Display with hanger

**Pliers set**



Dimensions of box: 255x185x48 mm

**CONTENTS** 101202 / 110303 / 101302

| Code          | No. of Items | €            |   |
|---------------|--------------|--------------|---|
| <b>101210</b> | 3            | <b>38,90</b> | 1 |

**CUTTING WIRE:** ○ Soft / ◐ Semi-hard / ◑ Hard / ● Piano wire

## Automatic adjustment waterpump pliers

Cr-V-Mo  
STEEL



Quick adjustment to the size of the bolt

- Jaws with hardened teeth (60 HRC).
- Big mouth thickness (12 mm), allowing more tightening force.
- Finishing: black Phosphate surface. Polished jaws, P.V.C. covered handles.

| Code          | L mm | L " | Max. Capac. $\varnothing$ mm | €            |   |
|---------------|------|-----|------------------------------|--------------|---|
| <b>115140</b> | 240  | 9,5 | 42                           | <b>29,70</b> | 6 |

Display with hanger

## Quick adjustment waterpump pliers

Cr-V  
STEEL



- High frequency hardening of dented groove (HRC 55-60)
- Finishing: black Phosphate surface.
- Polished jaws.

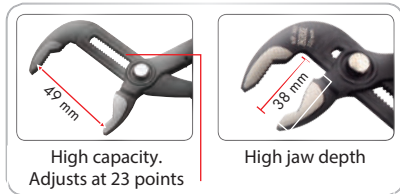

High capacity. Adjusts at 23 points

High jaw depth

Values for 115125

| Code          | L mm | L " | Max. Capac. $\varnothing$ mm | Depth mm | €            |   |
|---------------|------|-----|------------------------------|----------|--------------|---|
| <b>115115</b> | 150  | 6   | 28                           | 26       | <b>20,80</b> | 6 |
| <b>115120</b> | 180  | 7   | 37                           | 32       | <b>22,99</b> | 6 |
| <b>115125</b> | 240  | 9,5 | 49                           | 38       | <b>25,32</b> | 6 |
| <b>115130</b> | 300  | 12  | 68                           | 47       | <b>35,76</b> | 5 |
| <b>115135</b> | 400  | 16  | 95                           | 64       | <b>64,00</b> | 3 |

Display with hanger (except 115135)

## Groove joint waterpump pliers

DIN  
8976

Cr-V  
STEEL



Milled groove

- Satin finish coated

| Code          | L mm | L " | Max. Capac. $\varnothing$ mm | €            |   |
|---------------|------|-----|------------------------------|--------------|---|
| <b>111199</b> | 200  | 8   | 35                           | <b>16,06</b> | 6 |
| <b>111200</b> | 250  | 10  | 50                           | <b>18,60</b> | 6 |
| <b>111201</b> | 300  | 12  | 50                           | <b>25,19</b> | 6 |

Display with hanger

## Box joint waterpump pliers

DIN  
8976

Cr-V  
STEEL



Black finish

- Opening in 7 fixed positions
- Male-female joint
- Hardened jaws

| Code          | L mm | L " | Max. Capac. $\varnothing$ mm | €            |   |
|---------------|------|-----|------------------------------|--------------|---|
| <b>115105</b> | 250  | 10  | 36                           | <b>23,54</b> | 6 |

Display with hanger

**Insulated cutting and handling pliers**

DIN 5746  
EN 60900

**High leverage**

Certification mark of compliance to the EN 60900

Cr-V  
STEEL

Handgrips covered with special insulating material

| CUTTING TABLE |                           |
|---------------|---------------------------|
|               | Ø mm<br>101804/<br>101805 |
| ○             | 4/5                       |
| ◐             | 2,8/3,5                   |
| ◑             | 1,8/2,4                   |
| ●             | 1,6/2                     |



**EN 60900 STANDARD**  
Insulated tools used for jobs on voltages of up to 1000 V in AC or up to 1500 V in DC.

| Code          | L mm | L " | €            |   |
|---------------|------|-----|--------------|---|
| <b>101804</b> | 180  | 7   | <b>23,84</b> | 6 |
| <b>101805</b> | 200  | 8   | <b>26,21</b> | 5 |

Display with hanger

**Diagonal cutting pliers**

DIN 5749  
EN 60900

**High leverage**

Cr-V  
STEEL



| CUTTING TABLE |                          |
|---------------|--------------------------|
| Wire          | Ø mm<br>101823<br>101824 |
| ○             | 4                        |
| ◐             | 3                        |
| ◑             | 2                        |
| ●             | 1,6                      |



| Code          | L mm | L " | €            |   |
|---------------|------|-----|--------------|---|
| <b>101823</b> | 160  | 6   | <b>22,26</b> | 6 |
| <b>101824</b> | 180  | 7   | <b>23,95</b> | 5 |

Display with hanger

**Insulated pliers set**

**High leverage**



Dimensions of box 255x185x48 mm



**CONTENTS** 101804 / 101824 / 101813

| Code          | No. of Items | €            |   |
|---------------|--------------|--------------|---|
| <b>101862</b> | 3            | <b>74,91</b> | 1 |

**Long nose pliers with side cutter**

DIN 5745  
EN 60900

**High leverage**

Cr-V  
STEEL



| Code          | L mm | L " | €            |   |
|---------------|------|-----|--------------|---|
| <b>101812</b> | 160  | 6   | <b>24,22</b> | 6 |
| <b>101813</b> | 200  | 8   | <b>26,66</b> | 5 |

Display with hanger

## Insulated combination pliers

DIN 5746

EN 60900

Cr-V  
STEEL



### CUTTING TABLE

|   | Ø mm                         |
|---|------------------------------|
|   | 101801/<br>101802/<br>101803 |
| ○ | 4/4/4                        |
| ◐ | 2,8/3/3                      |
| ◑ | 1,8/2/2                      |
| ● | 1,4/1,6/1,6                  |



| Code   | L mm | L " | €     | ⊞ |
|--------|------|-----|-------|---|
| 101801 | 160  | 6   | 19,73 | 6 |
| 101802 | 180  | 7   | 21,16 | 6 |
| 101803 | 200  | 8   | 23,26 | 5 |

Display with hanger

## Diagonal cutting pliers

DIN 5749

EN 60900

Cr-V  
STEEL



| Code   | L mm | L " | €     | ⊞ |
|--------|------|-----|-------|---|
| 101821 | 160  | 6   | 19,73 | 6 |
| 101822 | 180  | 7   | 21,24 | 5 |

Display with hanger

## Long nose pliers

DIN 5745

EN 60900

Cr-V  
STEEL



| Code   | L mm | L " | €     | ⊞ |
|--------|------|-----|-------|---|
| 101810 | 160  | 6   | 21,48 | 6 |
| 101811 | 200  | 8   | 23,64 | 6 |

Display with hanger

## Heavy-duty diagonal cutting pliers

DIN 5749

EN 60900

Cr-V  
STEEL



| Code   | L mm | L " | €     | ⊞ |
|--------|------|-----|-------|---|
| 101825 | 180  | 7   | 22,78 | 6 |
| 101826 | 200  | 8   | 25,52 | 6 |

Display with hanger

## Bent long nose pliers

DIN 5745

EN 60900

Cr-V  
STEEL



| Code   | L mm | L " | €     | ⊞ |
|--------|------|-----|-------|---|
| 101815 | 200  | 8   | 25,49 | 6 |

Display with hanger

**Flat nose pliers**

DIN 5745

EN 60900

Cr-V STEEL



| Code          | L mm | L " | €            |   |
|---------------|------|-----|--------------|---|
| <b>101835</b> | 160  | 6   | <b>20,32</b> | 6 |

Display with hanger

**Round nose pliers**

DIN 5745

EN 60900

Cr-V STEEL



| Code          | L mm | L " | €            |   |
|---------------|------|-----|--------------|---|
| <b>101830</b> | 160  | 6   | <b>19,49</b> | 6 |

Display with hanger

**Insulated wire stripping pliers**

EN 60900

Cr-V STEEL



| Code          | L mm | L " | €            |   |
|---------------|------|-----|--------------|---|
| <b>101840</b> | 160  | 6   | <b>30,24</b> | 6 |

Display with hanger

**Insulated water pump pliers**

EN 60900

Cr-V STEEL



| Code          | L mm | L " | €            |   |
|---------------|------|-----|--------------|---|
| <b>101845</b> | 240  | 9,5 | <b>30,18</b> | 6 |

Display with hanger

**Insulated wire stripper**

EN 60900

Cr-V STEEL



**CUTTING TABLE**

| Code   | Wire Ø mm   |
|--------|-------------|
| 101848 | <b>13,5</b> |

- Special shape of cutting edges for cables
- Polished head finish
- With mechanical stop
- Bi-material and ergonomic handles



| Code          | L mm | L " | €            |   |
|---------------|------|-----|--------------|---|
| <b>101848</b> | 250  | 10  | <b>46,50</b> | 6 |

Display with hanger

Not suitable for cutting steel wire or copper twisted cable

**Insulated**



Dimensions of box 255x185x48 mm



**CONTENTS** 101802 / 101822 / 101811

| Code          | No. of Items | €            |   |
|---------------|--------------|--------------|---|
| <b>101860</b> | 3            | <b>67,00</b> | 1 |

## Circlip pliers Seeger

DIN 5254

Cr-V STEEL

EXTERNAL STRAIGHT NOSE



| Code          | Ø mm      | L mm | €            |   |
|---------------|-----------|------|--------------|---|
| <b>106202</b> | 10 to 25  | 140  | <b>15,48</b> | 6 |
| <b>106203</b> | 19 to 60  | 180  | <b>17,18</b> | 6 |
| <b>106204</b> | 40 to 100 | 220  | <b>19,58</b> | 6 |
| <b>106220</b> | 85 to 165 | 300  | <b>27,97</b> | 6 |

Display with hanger

DIN 5254

Cr-V STEEL

EXTERNAL BENT NOSE



| Code          | Ø mm      | L mm | €            |   |
|---------------|-----------|------|--------------|---|
| <b>106206</b> | 10 to 25  | 140  | <b>15,68</b> | 6 |
| <b>106207</b> | 19 to 60  | 180  | <b>17,70</b> | 6 |
| <b>106208</b> | 40 to 100 | 220  | <b>19,72</b> | 6 |
| <b>106225</b> | 85 to 165 | 300  | <b>28,08</b> | 6 |

Display with hanger

DIN 5256

Cr-V STEEL

INTERNAL STRAIGHT NOSE



| Code          | Ø mm      | L mm | €            |   |
|---------------|-----------|------|--------------|---|
| <b>106209</b> | 12 to 25  | 140  | <b>15,15</b> | 6 |
| <b>106210</b> | 19 to 60  | 180  | <b>17,26</b> | 6 |
| <b>106211</b> | 40 to 100 | 220  | <b>19,30</b> | 6 |
| <b>106230</b> | 85 to 165 | 300  | <b>27,69</b> | 6 |

Display with hanger

DIN 5256

Cr-V STEEL

INTERNAL BENT NOSE



| Code          | Ø mm      | L mm | €            |   |
|---------------|-----------|------|--------------|---|
| <b>106212</b> | 12 to 25  | 140  | <b>15,15</b> | 6 |
| <b>106213</b> | 19 to 60  | 180  | <b>17,84</b> | 6 |
| <b>106214</b> | 40 to 100 | 220  | <b>20,01</b> | 6 |
| <b>106235</b> | 85 to 165 | 300  | <b>28,49</b> | 6 |

Display with hanger

## Circlip pliers set



Dimensions of box: 255x185x48 mm

### CONTENTS

**101218** 106202 / 106206 / 106209 / 106212 (L 140 mm)

**101220** 106203 / 106207 / 106210 / 106213 (L 180 mm)

| Code          | No. of Items | €            |   |
|---------------|--------------|--------------|---|
| <b>101218</b> | 4            | <b>61,46</b> | 1 |
| <b>101220</b> | 4            | <b>70,00</b> | 1 |

## Circlip pliers set

L 220 MM



**CONTENTS** 106204 / 106208 / 106211 / 106214

| Code          | No. of Items | €            |   |
|---------------|--------------|--------------|---|
| <b>101222</b> | 4            | <b>78,60</b> | 1 |

**Curved jaw locking pliers with wire cutter**

Cr-V  
STEEL

Finish: polished jaws  
and nickel-plated body

Knurled lock nut to  
adjust to required  
opening

Quick-release lever

Curved jaws with wire-cutter

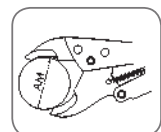

MO: maximum opening

| Code          | L<br>mm | L<br>" | MO<br>mm | €            |   |
|---------------|---------|--------|----------|--------------|---|
| <b>109101</b> | 135     | 5,5    | 30       | <b>9,60</b>  | 3 |
| <b>109102</b> | 190     | 7,5    | 42       | <b>13,69</b> | 3 |
| <b>109103</b> | 235     | 9      | 63       | <b>15,70</b> | 3 |

Display with hanger

**Straight jaw locking pliers**

Cr-V  
STEEL

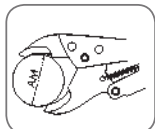

MO: maximum opening

| Code          | L<br>mm | L<br>" | MO<br>mm | €            |   |
|---------------|---------|--------|----------|--------------|---|
| <b>109104</b> | 190     | 7,5    | 42       | <b>13,82</b> | 3 |
| <b>109105</b> | 235     | 9      | 63       | <b>15,84</b> | 3 |

Display with hanger

**Chain locking pliers**

Cr-V  
STEEL



Maximum capacity: Ø 160 mm

| Code          | L<br>mm | L<br>" | €            |   |
|---------------|---------|--------|--------------|---|
| <b>109009</b> | 250     | 10     | <b>40,88</b> | 1 |

Display with hanger

**C clamp locking pliers**

Cr-V  
STEEL



| Code          | L<br>mm | L<br>" | €            |   |
|---------------|---------|--------|--------------|---|
| <b>109007</b> | 300     | 12     | <b>19,81</b> | 1 |

Display with hanger

**Welding clamp locking pliers**

Cr-V  
STEEL



| Code          | L<br>mm | L<br>" | €            |   |
|---------------|---------|--------|--------------|---|
| <b>109015</b> | 300     | 12     | <b>22,18</b> | 1 |

Display with hanger

## Diagonal cutting precision minipliers

Cr-V  
STEEL



Diagonal cutting for a better cutting and longer life of the edge.



### ANTI STATIC HANDLES

Special material handles allowing a controlled electrical discharging of the tool. Suitable for electric appliances.

- Induction-hardened cutting edges 55-60 HRC
- Complete induction tempered
- Bimaterial handle with antislip surface for a safer use
- Double plastic-coated handgrips
- Ergonomic extra size handgrips for a more comfortable use

| Code          | L mm | L " | €            |    |
|---------------|------|-----|--------------|----|
| <b>113175</b> | 115  | 4,5 | <b>12,62</b> | 12 |

Display with hanger

## Combination minipliers



| Code          | L mm | L " | €            |    |
|---------------|------|-----|--------------|----|
| <b>113185</b> | 115  | 4,5 | <b>12,62</b> | 12 |

Display with hanger

## Flat nose minipliers



| Code          | L mm | L " | €            |    |
|---------------|------|-----|--------------|----|
| <b>113165</b> | 130  | 5   | <b>12,62</b> | 12 |

Display with hanger

## Round nose cutting minipliers



| Code          | L mm | L " | €            |    |
|---------------|------|-----|--------------|----|
| <b>113155</b> | 140  | 5,5 | <b>12,62</b> | 12 |

Display with hanger

## End cut minipliers



| Code          | L mm | L " | €            |    |
|---------------|------|-----|--------------|----|
| <b>113180</b> | 115  | 4,5 | <b>12,62</b> | 12 |

Display with hanger

## Round nose minipliers



| Code          | L mm | L " | €            |    |
|---------------|------|-----|--------------|----|
| <b>113170</b> | 130  | 5   | <b>12,62</b> | 12 |

Display with hanger

**Long nose minipliers**



• Smooth inner part of the mouth



| Code          | L mm | L " | €            |    |
|---------------|------|-----|--------------|----|
| <b>113160</b> | 150  | 6   | <b>12,62</b> | 12 |

Display with hanger

**Diagonal cutting minipliers**



• Extra precise cutting angle



**21°**  
Cutting angle

| Code          | L mm | L " | €            |    |
|---------------|------|-----|--------------|----|
| <b>113192</b> | 125  | 5   | <b>12,62</b> | 12 |

Display with hanger



**45°**  
Cutting angle

| Code          | L mm | L " | €            |    |
|---------------|------|-----|--------------|----|
| <b>113194</b> | 125  | 5   | <b>12,62</b> | 12 |

Display with hanger

**Precision minipliers set**



Dimensions of box 255x185x48 mm

**CONTENTS** 113160 / 113175 / 113185 / 113180

| Code          | No. of Items | €            |   |
|---------------|--------------|--------------|---|
| <b>113190</b> | 4            | <b>51,47</b> | 1 |

**Precision minipliers and screwdrivers set**



Closed bag dimensions: 220x150x40 mm

**CONTENTS**

- 3 113160 - 113175 - 113180
- 6 1,5x50 - 2x50 - 2,5x50
- PH00x50 - PH0x50 - PH1x50

| Code          | No. of Items | €            |   |
|---------------|--------------|--------------|---|
| <b>113195</b> | 9            | <b>56,09</b> | 1 |

**Precision tweezers**

STAINLESS  
STEEL



• Anti-slip finished  
• Antimagnetic, antiacide

| Code          | L mm | L " | €           |   |
|---------------|------|-----|-------------|---|
| <b>113142</b> | 120  | 5   | <b>6,44</b> | 6 |

STAINLESS  
STEEL



| Code          | L mm | L " | €           |   |
|---------------|------|-----|-------------|---|
| <b>113144</b> | 120  | 5   | <b>5,24</b> | 6 |

## High leverage tower pincers

Cr-V  
STEEL

50% LESS EFFORT

### CUTTING TABLE

| Steel  | Ø mm |
|--------|------|
| 114010 |      |
| ○      | 6    |
| ◐      | 4,5  |
| ●      | 2,5  |



### HIGH LEVERAGE PRINCIPLE

Less distance between rotation axis and cutting edge.



|      | High Leverage | Standard |
|------|---------------|----------|
| L mm | 20,5          | 30       |

- Cutting edges hardened to HRC 58÷62
- Body entirely hardened to HRC 45
- Black finish

| Code   | L mm | L " | €     |   |
|--------|------|-----|-------|---|
| 114010 | 300  | 12  | 22,39 | 6 |

Display with hanger

## Tower Pincers

DIN  
9242

Cr-V  
STEEL



### CUTTING TABLE

| Steel | Ø mm |
|-------|------|
| ○     | 4    |
| ◐     | 3    |
| ●     | 2    |

- Induction-hardened side cutting edges
- Polished Head. Black finish

| Code   | L mm | L " | €     |   |
|--------|------|-----|-------|---|
| 114005 | 225  | 9   | 10,76 | 6 |
| 114006 | 250  | 10  | 11,59 | 6 |
| 114007 | 280  | 11  | 12,55 | 6 |
| 114008 | 300  | 12  | 14,17 | 6 |

Display with hanger

## Carpenters pincers

DIN  
9243

Cr-V  
STEEL



DIN  
9242

Cr-V  
STEEL



| Code   | L mm | L " | €     |   |
|--------|------|-----|-------|---|
| 114015 | 225  | 9   | 11,49 | 6 |
| 114016 | 250  | 10  | 12,27 | 6 |
| 114017 | 280  | 11  | 13,18 | 6 |
| 114018 | 300  | 12  | 14,74 | 6 |

Display with hanger

- Entirely Hardened. Induction-hardened cutting edges.
- Black finish.
- Polished head.

| Code   | L mm | L " | €     |   |
|--------|------|-----|-------|---|
| 114001 | 160  | 6   | 12,68 | 6 |
| 114002 | 180  | 7   | 15,12 | 6 |
| 114003 | 200  | 8   | 16,26 | 6 |

Display with hanger

**Compound diagonal cutting pliers**

Cr-V-Mo  
STEEL

| CUTTING TABLE |      |
|---------------|------|
| Wire          | Ø mm |
| ○             | 6    |
| ◐             | 5    |
| ◑             | 4    |
| ●             | 3,6  |



- Hardened cutting edges (63 HRC).
- Joint allows a large cutting capacity with minimum force.
- Mechanical stop.
- Bi-material and ergonomic handgrips.
- Black coating finish



| Code          | L mm | L " | €            |  |
|---------------|------|-----|--------------|---|
| <b>110320</b> | 200  | 8   | <b>32,91</b> | 5   |

Display with hanger

**Articulated diagonal cutting pliers 35°**

Cr-V-Mo  
STEEL

| CUTTING TABLE |      |
|---------------|------|
| Wire          | Ø mm |
| ○             | 6    |
| ◐             | 5    |
| ◑             | 4    |
| ●             | 3,6  |



Special for flush cutting due to the 35° inclination of the head

- Same characteristics and cutting capacity as 110320

| Code          | L mm | L " | €            |  |
|---------------|------|-----|--------------|---|
| <b>110322</b> | 200  | 8   | <b>37,25</b> | 5   |

Display with hanger

**One-hand wire cutter**

Cr-V  
STEEL

| CUTTING TABLE |      |
|---------------|------|
| Wire          | Ø mm |
| ◐             | 3    |
| ◑             | 2    |
| ●             | 1,6  |



- Shear cut
- With spring and mechanical stop
- PVC covered handgrips

| Code          | L mm | L " | €            |  |
|---------------|------|-----|--------------|---|
| <b>123200</b> | 180  | 7   | <b>25,11</b> | 1   |

Display with hanger

**Two-hand wire cutter**

Cr-V  
STEEL

| CUTTING TABLE |      |
|---------------|------|
| Wire          | Ø mm |
| ○             | 14   |
| ◐             | 12   |
| ●             | 10   |



- Exchangable drop-forged blades
- Shear cut
- Injected aluminium handles
- Anti-slip rubber handgrips

| Code          | L mm            | L " | €             |  |
|---------------|-----------------|-----|---------------|---|
| <b>123210</b> | 600             | 24  | <b>205,92</b> | 1   |
| SPARE BLADE   |                 |     |               |   |
| <b>123215</b> | for code 123210 |     | <b>124,25</b> | 1   |

## Bolt cutter

Cr-V-Mo  
STEEL

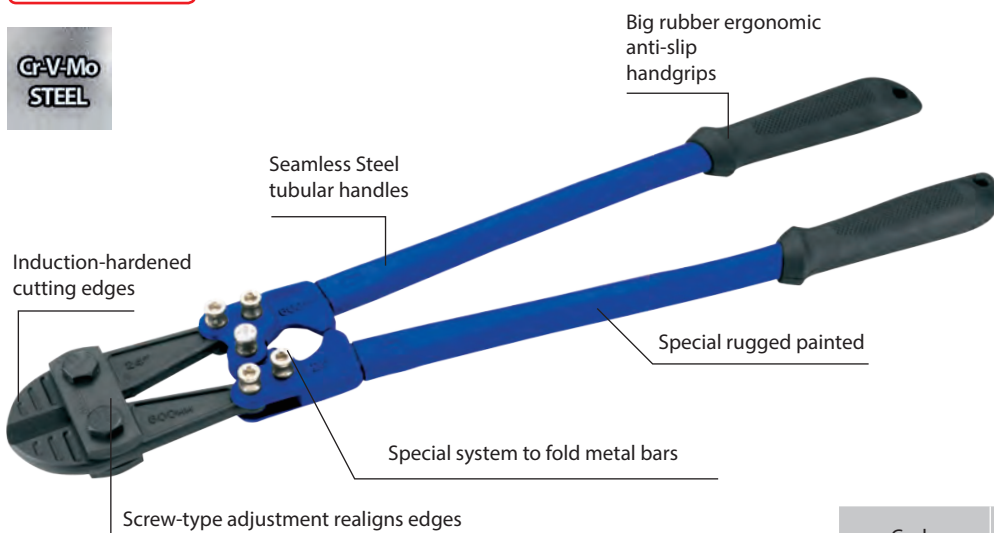

## CUTTING AND FOLDING TABLE

| Code   | Steel cutting capacity<br>Ø mm |        | Folding<br>Ø mm |
|--------|--------------------------------|--------|-----------------|
|        | 15 HRC                         | 40 HRC |                 |
| 123031 | 8                              | 5      | 6               |
| 123032 | 10                             | 6      | 8               |
| 123033 | 13                             | 7      | 9               |
| 123034 | 16                             | 8      | 12              |



132010

### ADJUSTABLE BOLT CUTTER

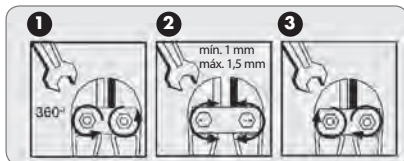

### INSTRUCTIONS FOR FOLDING

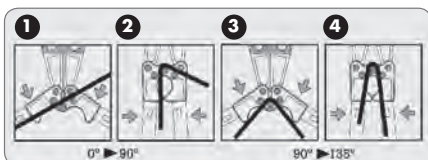

### SPARE BLADES

| Code          | L mm       | L " | €            |   |
|---------------|------------|-----|--------------|---|
| <b>123110</b> | for 123010 |     | <b>26,39</b> | 1 |
| <b>123111</b> | for 123031 |     | <b>32,67</b> | 1 |
| <b>123112</b> | for 123032 |     | <b>40,16</b> | 1 |
| <b>123113</b> | for 123033 |     | <b>51,20</b> | 1 |
| <b>123114</b> | for 123034 |     | <b>58,99</b> | 1 |

### DISPLAYER

| Code          | No. of Items | €             |
|---------------|--------------|---------------|
| <b>123120</b> | 7            | <b>513,24</b> |

**CONTENTS** 123031 (2) / 123032 (2)  
123033 (2) / 123034 (1)

- Drop-forged steel jaws
- Hardened cutting edges 56-61 HRC
- Big rubber ergonomic anti-slip handgrip

## Special bolt cutter

Cr-V  
STEEL

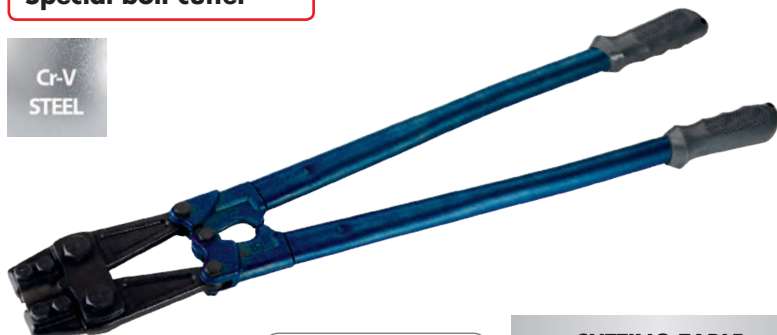

Spare blade with 3 cutting edges

### CUTTING TABLE

| Code   | Steel 15 HRC | Steel 40 HRC |
|--------|--------------|--------------|
| 123036 | 13           | 10           |
| 123038 | 13           | 10           |

| Code          | L mm              | L " | €             |   |
|---------------|-------------------|-----|---------------|---|
| <b>123036</b> | 600               | 24  | <b>68,25</b>  | 1 |
| <b>123038</b> | 900               | 36  | <b>112,91</b> | 1 |
| SPARE BLADES  |                   |     |               |   |
| <b>123037</b> | for 123036/123038 |     | <b>27,85</b>  | 1 |



**Wire cutter**

Cr-V  
STEEL

**High leverage**



| CUTTING TABLE |           |
|---------------|-----------|
| Code          | Wire Ø mm |
| 108052        | 13,5      |

**40% LESS EFFORT**

Not suitable for cutting steel wire or copper twisted cable

- Induction-hardened cutting edges
- Special edge shape. Japanese model.
- Mechanical stop
- Bimaterial and ergonomic handgrips

| Code          | L mm | L " | €            |   |
|---------------|------|-----|--------------|---|
| <b>108052</b> | 240  | 10  | <b>49,38</b> | 1 |

**Display with hanger**

Not suitable for cutting steel wire or copper twisted cable

- Hardened body 40÷48 HRC. Induction-hardened cutting edges 58÷63 HRC.
- Special edge shape. Clean cut without deformation or flattening of the cable

| Code          | L mm | L " | €            |   |
|---------------|------|-----|--------------|---|
| <b>108046</b> | 170  | 7   | <b>44,99</b> | 2 |
| <b>108048</b> | 230  | 9   | <b>53,21</b> | 2 |

**Display with hanger**

**Automatic cable shears**

Cr-V  
STEEL



| CUTTING TABLE |           |
|---------------|-----------|
| Code          | Wire Ø mm |
| 108046        | 9,5       |
| 108048        | 13,5      |

Not suitable for cutting steel wire or copper twisted cable

- Cable shears for copper and aluminium cable
- With mechanical stop
- Tubular ergonomic handles with ergonomic handgrips

| Code          | L mm       | L " | €             |   |
|---------------|------------|-----|---------------|---|
| <b>108055</b> | 600        | 24  | <b>159,17</b> | 1 |
| SPARE BLADE   |            |     |               |   |
| <b>108060</b> | for 108055 |     | <b>101,26</b> | 1 |

**Two-hand cable shears for copper and aluminium**

Cr-V  
STEEL



| CUTTING TABLE |      |
|---------------|------|
| Wire          | Ø mm |
| Copper        | 18   |
| Alum          | 26   |

Not suitable for cutting steel wire or copper twisted cable



**Cable sheath stripper**



INCLUDES:  
**+ 1**  
Blade

- 1 With plastic protection
- 2 Outside pusher for the blade
- 3 Screw for adjusting the thickness of the cutting

| Code          | L mm       | Ø Stripping | €            |   |
|---------------|------------|-------------|--------------|---|
| <b>108080</b> | 190        | 8-28        | <b>17,73</b> | 1 |
| SPARE BLADE   |            |             |              |   |
| <b>108081</b> | for 108080 |             | <b>5,12</b>  | 1 |

**Display with blister**

- Positioning lever for the blade
- Adjustment of the thickness of the cutting

| Code          | L mm            | Ø Stripping | €            |   |
|---------------|-----------------|-------------|--------------|---|
| <b>108085</b> | 140             | 8-28        | <b>22,72</b> | 1 |
| SPARE BLADE   |                 |             |              |   |
| <b>108086</b> | for code 108085 |             | <b>6,30</b>  | 1 |

**Display with blister**

## Precision wire Stripper



Bi material handle



Pair of blades in Steel SK5

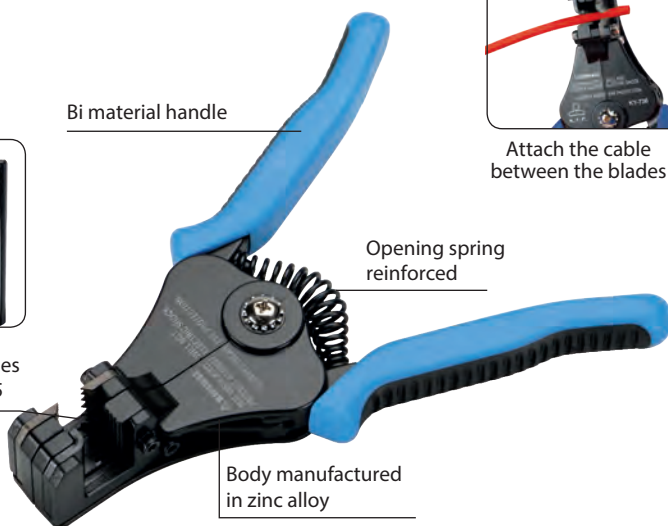

Opening spring reinforced

Body manufactured in zinc alloy

### STRIPPING MOVEMENT

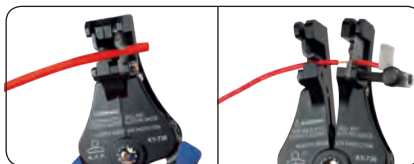

Attach the cable between the blades

With length stop for repetitive work



| Wire Stripper           | Min | Max |
|-------------------------|-----|-----|
| Ø mm                    | 0,5 | 3,2 |
| Section mm <sup>2</sup> | 0,2 | 8   |
| AWG                     | 24  | 8   |

| Code          | L mm | L " | €            |   |
|---------------|------|-----|--------------|---|
| <b>108392</b> | 170  | 7   | <b>31,40</b> | 1 |

Display with blister

## Automatic wire stripper

Security locking of the handle



Hard nylon body



Stripping length adjustable between 8 and 20 mm.



Stripping accuracy 0.2 to 6 mm<sup>2</sup>



Stripper for max Ø 2 mm

| Wire Stripper           | Min | Max |
|-------------------------|-----|-----|
| Ø mm                    | 0,5 | 2,6 |
| Section mm <sup>2</sup> | 0,2 | 6   |
| AWG                     | 24  | 10  |

| Code          | L mm | L " | €            |   |
|---------------|------|-----|--------------|---|
| <b>108390</b> | 180  | 7   | <b>25,89</b> | 1 |

Display with blister

## Multifunction stripper pliers

### CRIMPING

- Isolated 0.5 - 6 mm<sup>2</sup>
- Not insulated 5 - 6 mm<sup>2</sup>
- Autoignition 7 - 8 mm

Bi material handle

Cutter

Adjustable stripping



Precision screw for very thin cable stripping



### FUNCTIONS

- Wire stripper
- Crimper
- Cutters



| Wire Stripper           | Min  | Max |
|-------------------------|------|-----|
| Ø mm                    | 0,2  | 3,6 |
| Section mm <sup>2</sup> | 0,05 | 10  |
| AWG                     | 30   | 14  |

| Code          | L mm | L " | €            |   |
|---------------|------|-----|--------------|---|
| <b>108370</b> | 210  | 8   | <b>24,68</b> | 1 |

Display with blister

**Crimper for electronics connectors**

WITH RATCHET FUNCTION



For terminals:  
RJ11 6P4C  
RJ12 6P6C  
RJ45 8P8C



**Crimper for network connectors**

PVC coated ergonomic handle

Crimper



Anti-slip and ergonomic rubber base

For terminals:  
RJ11 6P4C  
RJ12 6P6C  
RJ45 8P8C



**Optical fiber cable stripper**

Bi material handle



Adjustable safety stop

Automatic opening spring

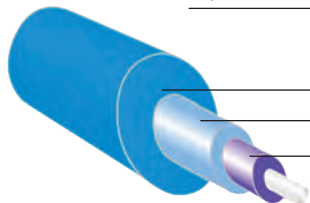

- 1 Outer coating 2-3 mm
- 2 Inner insulation 600-900 µm
- 3 Acrylic cover 125-250 µm
- 4 Fiber optic core

**4 DIFFERENT USES**



Flat cable stripper



Round cable stripper



Telephone cable cutter



Terminal crimping

- Ratchet function
- Heat treated metal body
- Bimaterial Handles

| Code   | L mm | €     |   |
|--------|------|-------|---|
| 108375 | 200  | 79,27 | 1 |

Display with blister

**FUNCTIONS**

- Wire stripper
- Crimper
- Cutters

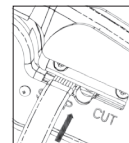

Flat cable

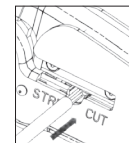

Round cable

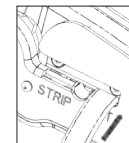

Cutters

| Code   | L mm | €     |   |
|--------|------|-------|---|
| 108377 | 140  | 50,80 | 1 |

Display with blister

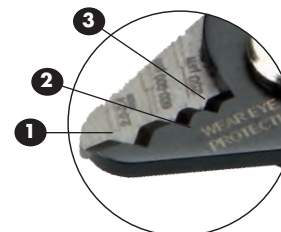

Double notch in V. Each notch is used for each coating of the cable

| Code   | L mm | €     |   |
|--------|------|-------|---|
| 108075 | 150  | 22,54 | 1 |

Display with blister

## Ratchet crimping pliers for insulated terminals



**FOR INSULATED TERMINALS**  
0,5 - 6 mm<sup>2</sup>



108356 head included

- 1 Heat treated interchangeable heads
- 2 Crimping strength adjusting mechanis
- 3 Ratchet mechanism
- 4 Releasing lever. Can not open tool until the setting is finished if this lever is not actuated

| Code          | L mm | €            |   |
|---------------|------|--------------|---|
| <b>108355</b> | 250  | <b>85,80</b> | 1 |

Display with blister

## Ratchet crimping pliers for non-insulated terminals



**FOR NON-INSULATED TERMINALS**  
0,5 - 6 mm<sup>2</sup>



108361 head included

• Same features as 108355

| Code          | L mm | €            |   |
|---------------|------|--------------|---|
| <b>108360</b> | 250  | <b>72,35</b> | 1 |

Display with blister

## Interchangeable heads for crimping pliers

| Insulated terminals<br>0.5-6 mm <sup>2</sup> | Non-insulated terminals<br>0.5-6 mm <sup>2</sup> | Tubular terminals<br>0.5-6 mm <sup>2</sup> | Tubular terminals<br>6-16 mm <sup>2</sup> | Barrel open terminals<br>0.5-6 mm <sup>2</sup> | Coaxial connectors terminals<br>BNC/TNC | Coaxial terminals CATV<br>RG-59/RG-6 |
|--|--|--|---|--|---|--------------------------------------|
|  |  |  |   |  |   |                                      |
| 108356                                       | 108361   | 108368                                     | 108369                                    | 108364   | 108366                                  | 108367                               |

- Easy attachment to the pliers using two screws
- Valid for crimpers 108355 and 108360

| Code          | €            |   |
|---------------|--------------|---|
| <b>108356</b> | <b>24,88</b> | 1 |
| <b>108361</b> | <b>24,88</b> | 1 |
| <b>108364</b> | <b>24,88</b> | 1 |
| <b>108366</b> | <b>24,88</b> | 1 |
| <b>108367</b> | <b>24,88</b> | 1 |
| <b>108368</b> | <b>24,88</b> | 1 |
| <b>108369</b> | <b>24,88</b> | 1 |

## Crimper Kit



Box dimensions: 290 x 230 x 55 mm



### CONTENTS

- 1 Crimper 108355
- 7 interchangeable heads  
108356 (assembled), 108361, 108364,  
108366, 108367, 108368, 108369
- 1 Hex key
- 2 Replacement screws

| Code          | No. of Items | €             |   |
|---------------|--------------|---------------|---|
| <b>108352</b> | 11           | <b>143,92</b> | 1 |

**Coaxial wire stripper**



Blade holder with preset blades

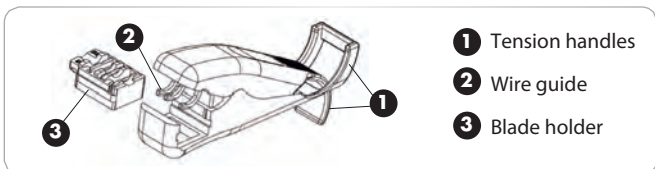

Special design so to strip in one time (RG6 - RG59)

**USING GUIDE**

1. Press both handles and insert wire
2. Keep wire pressed with one hand on the blades and with the other turn round the stripper three times

- Stripping length preadjustable
- Body made of high quality nylon

| Code          | L mm | €            |   |
|---------------|------|--------------|---|
| <b>108380</b> | 150  | <b>17,49</b> | 1 |

Display with blister

**Crimping pliers for insulated and non-insulated terminals**

FOR INSULATED TERMINALS



FOR NON-INSULATED TERMINALS

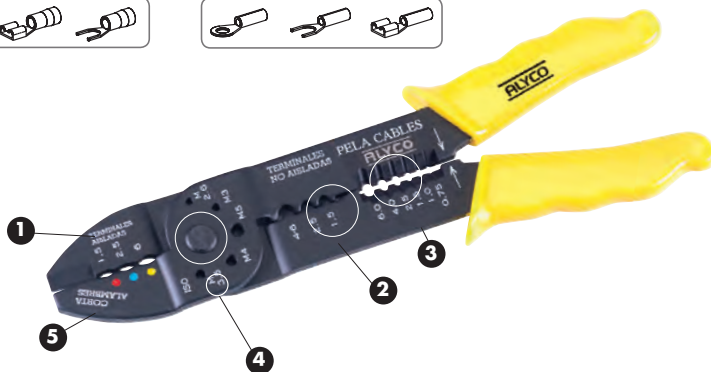

- 1 Insulated terminal crimper (0.5-6 mm<sup>2</sup>)
- 2 Non-insulated terminal crimper (0.5-6 mm<sup>2</sup>)
- 3 Wire stripper (0.5-6 mm<sup>2</sup>)
- 4 Shears without any burr of M2.5 to M5 bolts
- 5 Wire cutter

| Code          | L mm | €            |   |
|---------------|------|--------------|---|
| <b>108002</b> | 250  | <b>16,73</b> | 4 |

Display with blister

**Crimping pliers for non-insulated terminals**

FOR NON-INSULATED TERMINALS  
0,5 - 6 mm<sup>2</sup>

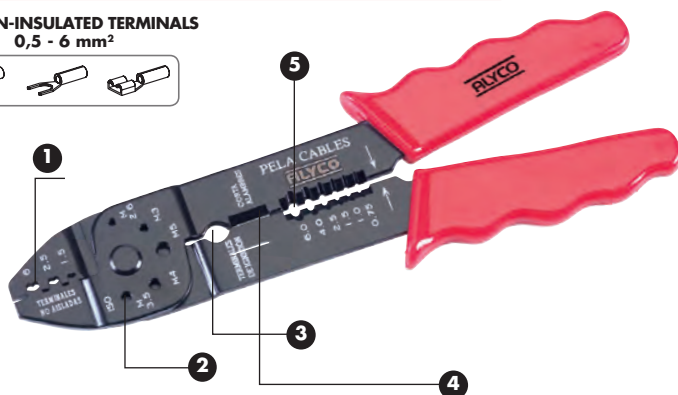

- 1 Terminal crimper (0.75-6 mm<sup>2</sup>)
- 2 Shear bolts from M2.5 to M5
- 3 Crimping ignition terminals
- 4 Wire cutter
- 5 Wire stripper (0.75-6 mm<sup>2</sup>)

| Code          | L mm | €            |   |
|---------------|------|--------------|---|
| <b>108003</b> | 250  | <b>10,20</b> | 4 |

Display with blister

**Crimping pliers set**



Box dimensions: 375 x 275 x 55 mm

**SET COMPOSITION**



**INSULATED TERMINALS**



| Code          | No. of Items | €            |   |
|---------------|--------------|--------------|---|
| <b>108006</b> | 147          | <b>50,82</b> | 1 |

## Stripping electrician's scissors

STAINLESS  
STEEL

45 MM LONG EDGE

Ergonomic handgrips allowing more cutting capacity with the minimum effort



These scissors are not insulated. Must not be used on energized electrical circuits.

| CUTTING TABLE |                         |
|---------------|-------------------------|
| Wire Ø mm     | Section mm <sup>2</sup> |
| 7             | 38                      |



- Jaws made of high-quality Stainless Steel
- Bimaterial handgrips: Robust nylon and soft rubber
- Ergonomic handgrips

| Code          | L mm | L " | €            |    |
|---------------|------|-----|--------------|----|
| <b>108013</b> | 150  | 6   | <b>15,08</b> | 12 |

Display with blister

## Multi-purpose electrician's scissors

STAINLESS  
STEEL

50 MM LONG EDGE



These scissors are not insulated. Must not be used on energized electrical circuits.



- Micro indented cutting edges (non-slip)
- Bimaterial handgrips: Robust nylon and soft rubber
- Wire stripper

| Code          | L mm | L " | €            |    |
|---------------|------|-----|--------------|----|
| <b>108015</b> | 145  | 5,5 | <b>10,11</b> | 12 |

**DISPLAYER**

|               |             |               |   |
|---------------|-------------|---------------|---|
| <b>108040</b> | 24 scissors | <b>242,58</b> | 1 |
|---------------|-------------|---------------|---|

## Electrician's scissors with sheath



| Code          | Type              | €            |    |
|---------------|-------------------|--------------|----|
| <b>108215</b> | Scissors + sheath | <b>12,81</b> | 12 |
| <b>108210</b> | Sheath            | <b>3,39</b>  | 12 |

Display with blister

## Electrician's kit with pouch



### CONTENTS

- 1 Scissors 108015
- 1 Stripper knife 108030
- 1 Leather sheath

- Reinforced leather pouch with rivets at seams
- With slotted strip at the top to attach to belt

| Code          | €            |   |
|---------------|--------------|---|
| <b>108020</b> | <b>19,59</b> | 6 |

Display with blister

**Reinforced electrician's scissors**

STAINLESS  
STEEL

60 MM LONG EDGE



These scissors are not insulated. Must not be used on energized electrical circuits.

- Long cutting edges. Serrated blades with notch for stripping cables.
- Automatic opening spring for easier handling

| Code          | L mm | €            |   |
|---------------|------|--------------|---|
| <b>108035</b> | 210  | <b>16,16</b> | 6 |

Display with blister

**Reinforced offset scissors**

STAINLESS  
STEEL

100 MM LONG EDGE



These scissors are not insulated. Must not be used on energized electrical circuits.

- Hardened and serrated blades
- Spring for automatic opening for easier handling

| Code          | L mm | €            |   |
|---------------|------|--------------|---|
| <b>108125</b> | 250  | <b>17,13</b> | 6 |

Display with blister

**Multi-purpose stainless scissors**

STAINLESS  
STEEL



| Code          | L mm | €            |   |
|---------------|------|--------------|---|
| <b>108330</b> | 150  | <b>13,03</b> | 6 |
| <b>108335</b> | 200  | <b>15,98</b> | 6 |
| <b>108340</b> | 250  | <b>20,78</b> | 6 |

Display with blister

**Stainless household scissors**

STAINLESS  
STEEL

50 MM LONG EDGE



- Microdented edges • Big notch for tightening
- Housing for breaking • Bottle opener

| Code          | L mm | €            |   |
|---------------|------|--------------|---|
| <b>108350</b> | 220  | <b>20,96</b> | 6 |

Display in sheath

**Insulated electrician's scissors**

STAINLESS  
STEEL

45 MM LONG EDGE

EN 60900



**EN 60900 STANDARD**

Insulated tools used for jobs on voltages of up to 1000 V in AC or up to 1500 V in DC.

VDE certificate



- Insulated bimaterial handgrips
- Induction-hardened cutting edges HRC 51 ÷ 53
- Wire stripper notch

| Code          | L mm | €            |   |
|---------------|------|--------------|---|
| <b>108315</b> | 165  | <b>18,74</b> | 6 |

Display with blister

## Electrician's folding knife

STAINLESS  
STEEL

65 MM LONG EDGE



These scissors are not insulated. Must not be used on energized electrical circuits.

- Blade 2.5 mm. thick
- Even and serrated cutting edge
- Double notch for stripping cables
- Bimaterial ergonomic handgrips

| Code          | L open mm | L close mm | €             |    |
|---------------|-----------|------------|---------------|----|
| <b>108032</b> | 210       | 120        | <b>12,47</b>  | 12 |
| DISPENSER     |           |            |               |    |
| <b>108034</b> | 24 units  |            | <b>299,27</b> | 1  |

Display with blister

## Knife in nylon pouch

STAINLESS  
STEEL

85 MM LONG EDGE



Metallic clip



Nylon pouch

- Aluminium body with metallic inner protection
- Hand contact area covered with wood. Ergonomic shape.
- Metallic clip in the back part
- Blade open position blocking system.
- In individual nylon pouch.

| Code          | L mm open | L mm closed | €            |   |
|---------------|-----------|-------------|--------------|---|
| <b>101270</b> | 205       | 120         | <b>13,90</b> | 6 |

Display with blister

## Aluminum handle knife

STAINLESS  
STEEL

85 MM LONG EDGE



Metallic clip

- Stainless steel blade
- Aluminium and anti-slip plastic handle
- Blockage system of blade in open position

| Code          | L mm open | L mm closed | €            |   |
|---------------|-----------|-------------|--------------|---|
| <b>101272</b> | 190       | 115         | <b>10,60</b> | 6 |

Display with blister

**Electrician's knife double blade**

STAINLESS  
STEEL

60 MM LONG EDGE



These scissors are not insulated. Must not be used on energized electrical circuits.

| Code          | L open mm | L close mm | €            |   |
|---------------|-----------|------------|--------------|---|
| <b>101276</b> | 210       | 110        | <b>10,70</b> | 6 |

Display with blister

**Electrician's knife**

STAINLESS  
STEEL

LONG EDGE 45 MM



These knives are not insulated. Must not be used on energized electrical circuits.

- Blade 2.5 mm. thick
- Cutting edge hardened to 57 - 60 HRC
- Handle made of reinforced nylon.
- With plastic protector

| Code          | L mm | €           |    |
|---------------|------|-------------|----|
| <b>108030</b> | 155  | <b>6,44</b> | 12 |

Display with blister

**Electrician's stripping insulated knife**

EN 60900

Cr-V  
STEEL

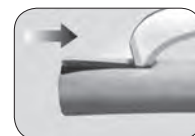

VDE certificate



- Bimaterial handgrip covered with insulating material
- Double cutting edge, curved and straight
- The nail does not damage the driver

| Code          | L mm |    | €            |   |
|---------------|------|----|--------------|---|
| <b>108095</b> | 200  | 40 | <b>17,50</b> | 6 |

Display with blister

**Electrician's insulated knife**

EN 60900

Cr-V  
STEEL



VDE certificate



- Bimaterial handgrip covered with insulating material

| Code          | L mm |    | €            |   |
|---------------|------|----|--------------|---|
| <b>108090</b> | 200  | 50 | <b>12,89</b> | 6 |

Display with blister

## Compound action aviation shears

Cr-V  
STEEL

### CUTTING TABLE

| Sheet        | Thick mm |
|--------------|----------|
| Copper       | 1,5      |
| Rolled steel | 1,2      |
| Steel HRC30  | 1        |



- Forged jaws
- Self-opening action spring
- Serrated, non-slip and hardened cutting edges
- Compound system to multiply cutting force
- Safety latch
- Bimaterial and ergonomic handgrips

| Code          | L mm | L " | €            |  |
|---------------|------|-----|--------------|---|
| <b>108100</b> | 250  | 10  | <b>16,31</b> | 6   |

Display with blister

## Long nose aviation shears

Cr-V  
STEEL



| Code          | L mm | L " | €            |  |
|---------------|------|-----|--------------|---|
| <b>108105</b> | 300  | 12  | <b>17,30</b> | 6   |

Display with blister

## Left cutting aviation shears

Cr-V  
STEEL

REINFORCED



| Code          | L mm | L " | €            |  |
|---------------|------|-----|--------------|---|
| <b>108110</b> | 250  | 10  | <b>18,61</b> | 6   |

Display with blister

## Right cutting aviation shears

Cr-V  
STEEL

REINFORCED



| Code          | L mm | L " | €            |  |
|---------------|------|-----|--------------|---|
| <b>108120</b> | 250  | 10  | <b>18,61</b> | 6   |

Display with blister

**Tinmans snips**



- Steel-forged jaws
- With mechanical stop
- Painted finish. Polished jaws.

| Code          | L mm | L " | €            |  |
|---------------|------|-----|--------------|---|
| <b>108300</b> | 250  | 10  | <b>16,93</b> | 6   |
| <b>108302</b> | 300  | 12  | <b>23,47</b> | 6   |

Display with blister

**Revolving punch pliers**

**6 Ø OF MOUTH:**  
2, 2'5, 3, 3'5, 4, 4'5 MM



**Use for perforating leather, textil and plastic**

- Painted body to avoid oxidation
- Ergonomic handles with plastic protector
- Revolving head with 6 diametres of punches
- Articulation punching to less the effort
- Spring to open and pull to close

| Code          | L mm | €            |  |
|---------------|------|--------------|---|
| <b>111445</b> | 250  | <b>14,13</b> | 1   |

Display with blister

**Plastic tie tightener**



**INSTRUCTIONS FOR USE**



- Adjustable tightening pressure
- For ties between 2.2 y 4.8 mm

| Code          | Measure mm | €            |  |
|---------------|------------|--------------|---|
| <b>108395</b> | 160x130    | <b>30,70</b> | 1   |



## 04 Spanners and Wrenches

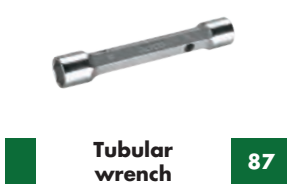
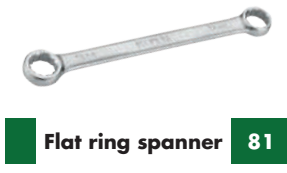
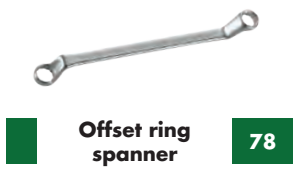
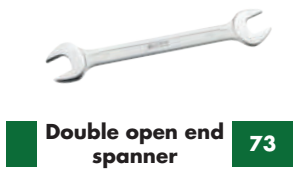

**Double open end spanner**

**DIN 3110**

**Cr-V STEEL**



- Satin finish and polished
- Bevelled ends for a better nut fitting
- 30° offset to reach confined places

| Code   | mm    | L mm | E mm | €     |    |
|--------|-------|------|------|-------|----|
| 191004 | 4x5   | 105  | 3,2  | 3,57  | 10 |
| 191005 | 6x7   | 122  | 3,2  | 3,70  | 10 |
| 191010 | 8x9   | 140  | 3,5  | 3,85  | 10 |
| 191015 | 10x11 | 156  | 4,5  | 4,03  | 10 |
| 191012 | 10x13 | 172  | 5,1  | 4,76  | 10 |
| 191020 | 12x13 | 172  | 5    | 4,95  | 10 |
| 191028 | 13x17 | 188  | 5,6  | 6,13  | 10 |
| 191025 | 14x15 | 188  | 5,5  | 5,26  | 10 |
| 191030 | 16x17 | 204  | 6    | 6,22  | 10 |
| 191033 | 17x19 | 220  | 6,5  | 6,74  | 10 |
| 191035 | 18x19 | 220  | 6,5  | 6,81  | 10 |
| 191038 | 19x22 | 234  | 7,2  | 7,98  | 5  |
| 191040 | 20x22 | 234  | 7,5  | 7,98  | 5  |
| 191045 | 21x23 | 247  | 7,5  | 8,64  | 5  |
| 191047 | 22x24 | 247  | 7,5  | 8,85  | 5  |
| 191050 | 24x26 | 266  | 8,5  | 10,14 | 5  |
| 191055 | 24x27 | 266  | 8,5  | 10,14 | 5  |
| 191060 | 25x28 | 285  | 8,5  | 11,54 | 5  |
| 191065 | 27x29 | 300  | 9,5  | 13,37 | 5  |
| 191070 | 30x32 | 302  | 9,5  | 15,68 | 5  |
| 191072 | 32x36 | 320  | 10   | 25,87 | 5  |
| 191073 | 34x36 | 320  | 10   | 27,15 | 5  |
| 191075 | 36x41 | 380  | 12,2 | 30,26 | 4  |
| 191076 | 41x46 | 415  | 14,7 | 44,84 | 2  |
| 191077 | 46x50 | 465  | 15,7 | 56,04 | 2  |

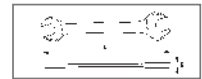

| Code   | mm             | L mm | E mm | €     |   |
|--------|----------------|------|------|-------|---|
| 190002 | 1/4"x5/16"     | 122  | 3,3  | 3,70  | 1 |
| 190004 | 5/16"x3/8"     | 140  | 3,6  | 3,85  | 1 |
| 190006 | 3/8"x7/16"     | 156  | 4,6  | 4,03  | 1 |
| 190008 | 7/16"x1/2"     | 172  | 5,1  | 4,95  | 1 |
| 190010 | 1/2"x9/16"     | 180  | 5,1  | 5,26  | 1 |
| 190012 | 9/16"x5/8"     | 188  | 5,6  | 5,55  | 1 |
| 190014 | 5/8"x11/16"    | 204  | 6,1  | 6,22  | 1 |
| 190016 | 11/16"x3/4"    | 220  | 6,5  | 6,81  | 1 |
| 190018 | 3/4"x7/8"      | 234  | 7,2  | 7,23  | 1 |
| 190020 | 13/16"x7/8"    | 247  | 7,5  | 8,65  | 1 |
| 190022 | 15/16"x1"      | 266  | 8,2  | 10,14 | 1 |
| 190024 | 1"x1-1/8"      | 285  | 8,4  | 11,54 | 1 |
| 190026 | 1-1/8"x1-5/16" | 302  | 9,1  | 15,68 | 1 |
| 190028 | 1-1/16"x1-1/4" | 302  | 9,1  | 15,68 | 1 |
| 190030 | 1-7/16"x1-5/8" | 380  | 12,2 | 30,22 | 1 |

**Double open end spanner set in plastic holder**



**CONTENTS**

6x7, 8x9, 10x11, 12x13, 14x15, 16x17, 18x19, 20x22 mm

| Code   | No. of Items | €     |   |
|--------|--------------|-------|---|
| 191091 | 8            | 42,19 | 2 |

## Double open end spanner set in carton box



### CONTENTS

**191082:** 8x9, 10x11, 12x13, 14x15, 16x17, 18x19 mm  
**191080:** 6x7, 8x9, 10x11, 12x13, 14x15, 16x17, 18x19, 20x22 mm

| Code          | No. of Items | €            |   |
|---------------|--------------|--------------|---|
| <b>191082</b> | 6            | <b>31,14</b> | 2 |
| <b>191080</b> | 8            | <b>41,66</b> | 2 |

## Double open end spanner set in nylon pouch

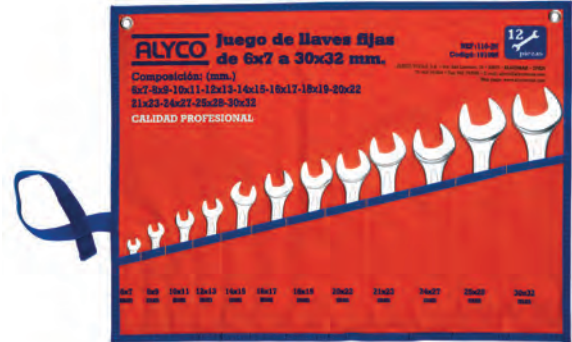

### CONTENTS

**191086:** 6x7, 8x9, 10x11, 12x13, 14x15, 16x17, 18x19, 20x22, 21x23, 24x27, 25x28, 30x32 mm  
**190045:** 1/4"x5/16" • 5/16"x3/8" • 3/8"x7/16" • 1/2"x9/16" • 9/16"x5/8" • 5/8"x11/16" • 11/16"x3/4" • 3/4"x7/8" • 13/16"x7/8" • 15/16"x1" • 1"x1-1/8" • 1-1/16"x1-1/4"

| Code          | No. of Items | €            |   |
|---------------|--------------|--------------|---|
| <b>191086</b> | 12           | <b>91,61</b> | 2 |
| <b>190045</b> | 12           | <b>88,68</b> | 2 |

### CONTENTS

**191081:** 6x7, 8x9, 10x11, 12x13, 14x15, 16x17, 18x19, 20x22 mm  
**190040:** 1/4"x5/16" • 5/16"x3/8" • 3/8"x7/16" • 1/2"x9/16" • 9/16"x5/8" • 5/8"x11/16" • 11/16"x3/4" • 3/4"x7/8"

| Code          | No. of Items | €            |   |
|---------------|--------------|--------------|---|
| <b>191081</b> | 8            | <b>42,18</b> | 2 |
| <b>190040</b> | 8            | <b>42,65</b> | 2 |

## Double open end spanner set in plastic holder



Box dimensions: 255x185x48 mm

### CONTENTS

6x7, 8x9, 10x11, 12x13, 14x15, 16x17, 18x19, 20x22 mm

| Code          | No. of Items | €            |   |
|---------------|--------------|--------------|---|
| <b>191096</b> | 8            | <b>43,90</b> | 2 |

### CONTENTS

6x7, 8x9, 10x11, 12x13, 14x15, 16x17, 18x19, 20x22, 21x23, 24x27, 25x28, 30x32 mm

| Code          | No. of Items | €            |   |
|---------------|--------------|--------------|---|
| <b>191085</b> | 12           | <b>88,87</b> | 2 |

**Black single open end spanner**

**DIN 894**

**Cr-V STEEL**



• Black finish

| Code   | mm | L mm | E mm | €     |   |
|--------|----|------|------|-------|---|
| 190917 | 17 | 170  | 6    | 2,49  | 1 |
| 190919 | 19 | 170  | 6    | 2,72  | 1 |
| 190922 | 22 | 193  | 8    | 3,19  | 1 |
| 190924 | 24 | 213  | 9    | 4,05  | 1 |
| 190927 | 27 | 240  | 9,5  | 4,91  | 1 |
| 190930 | 30 | 253  | 11   | 5,66  | 1 |
| 190932 | 32 | 277  | 11,5 | 6,39  | 1 |
| 190934 | 34 | 290  | 12   | 7,15  | 1 |
| 190936 | 36 | 309  | 12,5 | 8,76  | 1 |
| 190941 | 41 | 346  | 14   | 13,19 | 1 |

| Code   | mm | L mm | E mm | €     |   |
|--------|----|------|------|-------|---|
| 190946 | 46 | 380  | 15,5 | 14,80 | 1 |
| 190950 | 50 | 415  | 15,5 | 18,68 | 1 |
| 190955 | 55 | 456  | 16,5 | 23,04 | 1 |
| 190960 | 60 | 498  | 17,5 | 31,01 | 1 |
| 190965 | 65 | 520  | 18,5 | 37,32 | 1 |
| 190970 | 70 | 560  | 18,5 | 43,46 | 1 |
| 190975 | 75 | 630  | 20,5 | 51,32 | 1 |
| 190980 | 80 | 630  | 21,5 | 59,51 | 1 |
| 190985 | 85 | 680  | 22   | 72,45 | 1 |

**Insulated single open end wrench**

**Cr-V STEEL**



**VDE certificate**



**EN 60900 STANDARD**

Insulated tools used for jobs on voltages of up to 1000 V in AC or up to 1500 V in DC.



• Ergonomic handle coated with non-slip material

| Code   | mm | L mm | €     |   |
|--------|----|------|-------|---|
| 190157 | 7  | 88   | 12,89 | 1 |
| 190158 | 8  | 104  | 12,89 | 1 |
| 190159 | 9  | 104  | 14,15 | 1 |
| 190160 | 10 | 114  | 14,23 | 1 |
| 190161 | 11 | 124  | 14,84 | 1 |
| 190162 | 12 | 124  | 14,84 | 1 |
| 190163 | 13 | 154  | 16,33 | 1 |
| 190164 | 14 | 154  | 16,33 | 1 |

| Code   | mm | L mm | €     |   |
|--------|----|------|-------|---|
| 190166 | 16 | 170  | 17,90 | 1 |
| 190167 | 17 | 170  | 19,41 | 1 |
| 190168 | 18 | 180  | 19,98 | 1 |
| 190169 | 19 | 180  | 20,75 | 1 |
| 190171 | 21 | 202  | 24,06 | 1 |
| 190172 | 22 | 202  | 26,87 | 1 |
| 190174 | 24 | 237  | 29,93 | 1 |

## Combination spanner

DIN  
3113

Cr-V  
STEEL



Rounded edges

| Code   | mm | L mm | E mm | E1 mm | €     |    |
|--------|----|------|------|-------|-------|----|
| 191203 | 6  | 110  | 3,6  | 5     | 4,87  | 10 |
| 191206 | 7  | 110  | 3,6  | 5,5   | 4,94  | 10 |
| 191209 | 8  | 120  | 4,1  | 6     | 5,00  | 10 |
| 191212 | 9  | 130  | 4,1  | 6,5   | 5,84  | 10 |
| 191215 | 10 | 140  | 4,6  | 7     | 5,91  | 10 |
| 191218 | 11 | 150  | 5    | 7     | 6,48  | 10 |
| 191221 | 12 | 160  | 5,1  | 7,5   | 6,83  | 10 |
| 191224 | 13 | 170  | 5,5  | 8     | 7,25  | 10 |
| 191227 | 14 | 180  | 5,8  | 8,5   | 7,48  | 5  |
| 191230 | 15 | 190  | 6    | 9     | 7,74  | 5  |
| 191233 | 16 | 200  | 6,2  | 9,5   | 8,28  | 5  |
| 191236 | 17 | 210  | 6,5  | 10    | 8,83  | 5  |
| 191239 | 18 | 220  | 6,7  | 10,5  | 9,34  | 5  |
| 191242 | 19 | 230  | 7,3  | 11    | 10,57 | 5  |
| 191245 | 20 | 240  | 7,5  | 11,5  | 10,75 | 5  |
| 191248 | 21 | 250  | 7,8  | 12    | 12,16 | 5  |
| 191251 | 22 | 260  | 8    | 12,5  | 12,34 | 5  |
| 191254 | 23 | 260  | 8    | 12,5  | 13,17 | 5  |
| 191257 | 24 | 280  | 8,5  | 13,5  | 13,74 | 5  |
| 191260 | 25 | 295  | 8,8  | 14    | 14,80 | 5  |
| 191263 | 26 | 295  | 8,8  | 14    | 18,04 | 5  |
| 191266 | 27 | 310  | 9    | 15    | 19,46 | 5  |
| 191269 | 28 | 340  | 9,5  | 16,5  | 20,70 | 5  |
| 191272 | 29 | 340  | 9,5  | 16,5  | 20,90 | 5  |
| 191275 | 30 | 340  | 9,5  | 16,5  | 21,21 | 5  |
| 191278 | 32 | 360  | 9,7  | 17,5  | 23,73 | 5  |
| 191279 | 34 | 380  | 11,5 | 18    | 26,73 | 3  |
| 191281 | 36 | 410  | 13   | 18,2  | 39,38 | 3  |
| 191282 | 41 | 460  | 15,5 | 20    | 48,91 | 3  |
| 191283 | 46 | 500  | 16,2 | 21    | 62,46 | 3  |
| 191284 | 50 | 540  | 17,2 | 22,6  | 72,53 | 3  |

• Polished head and Satin finish

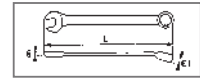

| Code   | mm      | L mm | E mm | E1 mm | €     |   |
|--------|---------|------|------|-------|-------|---|
| 190100 | 1/4"    | 100  | 3,7  | 4,5   | 4,87  | 1 |
| 190102 | 5/16"   | 120  | 4,1  | 5,5   | 5,00  | 1 |
| 190104 | 11/32"  | 130  | 4,1  | 6     | 5,85  | 1 |
| 190106 | 3/8"    | 140  | 4,6  | 6,5   | 5,91  | 1 |
| 190108 | 7/16"   | 150  | 4,7  | 6,5   | 6,48  | 1 |
| 190110 | 1/2"    | 170  | 5,5  | 7,5   | 7,25  | 1 |
| 190112 | 9/16"   | 180  | 5,6  | 8     | 7,48  | 1 |
| 190114 | 5/8"    | 200  | 5,8  | 9     | 8,28  | 1 |
| 190116 | 11/16"  | 210  | 6,3  | 9,5   | 9,34  | 1 |
| 190118 | 3/4"    | 230  | 7,1  | 10,4  | 10,57 | 1 |
| 190120 | 13/16"  | 250  | 7,5  | 11,4  | 12,16 | 1 |
| 190122 | 7/8"    | 260  | 8    | 11,9  | 12,34 | 1 |
| 190124 | 15/16"  | 280  | 8,2  | 12,9  | 13,74 | 1 |
| 190126 | 1"      | 295  | 8,7  | 13,4  | 14,80 | 1 |
| 190128 | 1-1/16" | 310  | 8,9  | 14,4  | 19,46 | 1 |
| 190130 | 1-1/8"  | 340  | 10   | 15,9  | 20,72 | 1 |
| 190132 | 1-1/4"  | 360  | 10,8 | 16,9  | 23,73 | 1 |

## Combination spanners set in plastic holder

### CONTENTS

8, 10, 11, 12, 13, 14, 17, 19 mm

| Code   | No. of Items | €     |   |
|--------|--------------|-------|---|
| 191291 | 8            | 62,49 | 2 |



**Combination spanner set in carton box**



**CONTENTS**

8, 10, 11, 12, 13, 14, 17, 19 mm

| Code          | No. of Items | €            |   |
|---------------|--------------|--------------|---|
| <b>191280</b> | 8            | <b>62,88</b> | 2 |

**Combination spanner set in nylon pouch**



**CONTENTS**

all sizes between 6 and 32 mm

| Code          | No. of Items | €             |   |
|---------------|--------------|---------------|---|
| <b>191286</b> | 26           | <b>305,57</b> | 1 |



**CONTENTS**

**190140:** 1/4" • 5/16" • 3/8" • 7/16" • 1/2" • 9/16" • 5/8" • 11/16"  
**190145:** 3/8" • 7/16" • 1/2" • 9/16" • 5/8" • 11/16" • 3/4" • 13/16" • 7/8" • 15/16" • 1" • 1-1/16"

| Code          | No. of Items | €             |   |
|---------------|--------------|---------------|---|
| <b>190140</b> | 8            | <b>54,59</b>  | 1 |
| <b>190145</b> | 12           | <b>127,79</b> | 1 |



**Combination spanner set in plastic holder**



Box dimensions: 255x185x48 mm

**CONTENTS**

8, 9, 10, 11, 12, 13, 14, 15, 16, 17, 18, 19 mm

| Code          | No. of Items | €            |   |
|---------------|--------------|--------------|---|
| <b>191285</b> | 12           | <b>92,66</b> | 2 |

**CONTENTS**

8, 10, 11, 12, 13, 14, 17, 19 mm

| Code          | No. of Items | €            |   |
|---------------|--------------|--------------|---|
| <b>191296</b> | 8            | <b>63,54</b> | 2 |

## Offset ring spanner

DIN  
838

Cr-V  
STEEL



Rounded edges

• Polished head and satin finish

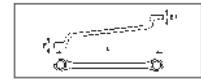

| Code   | mm    | L mm | E mm | E1 mm | €     |    |
|--------|-------|------|------|-------|-------|----|
| 191105 | 6x7   | 170  | 5,5  | 6,2   | 7,03  | 10 |
| 191110 | 8x9   | 182  | 6,5  | 7,4   | 7,69  | 10 |
| 191115 | 10x11 | 197  | 8    | 8,5   | 8,21  | 10 |
| 191120 | 12x13 | 212  | 9    | 9,5   | 8,68  | 10 |
| 191128 | 13x17 | 245  | 9    | 11    | 10,93 | 10 |
| 191125 | 14x15 | 227  | 10   | 10,5  | 9,42  | 10 |
| 191130 | 16x17 | 245  | 11   | 11,5  | 11,19 | 10 |
| 191133 | 17x19 | 265  | 11,4 | 11,9  | 12,84 | 10 |
| 191135 | 18x19 | 265  | 12   | 12,5  | 12,94 | 10 |
| 191138 | 19x22 | 288  | 12,4 | 12,9  | 14,93 | 5  |
| 191140 | 20x22 | 287  | 13   | 13,5  | 14,93 | 5  |
| 191145 | 21x23 | 310  | 13   | 14    | 16,85 | 5  |
| 191148 | 22x24 | 310  | 13   | 14    | 17,30 | 5  |
| 191150 | 24x26 | 330  | 14,5 | 15    | 20,92 | 5  |
| 191155 | 24x27 | 330  | 14,5 | 15    | 20,92 | 5  |
| 191160 | 25x28 | 350  | 15   | 15,5  | 24,30 | 5  |
| 191165 | 27x29 | 360  | 16   | 16,5  | 25,79 | 5  |
| 191170 | 30x32 | 372  | 16   | 17    | 29,43 | 5  |
| 191172 | 32x36 | 415  | 16,5 | 17,8  | 43,01 | 2  |
| 191175 | 36x41 | 460  | 17,3 | 19,2  | 51,36 | 2  |
| 191177 | 46x50 | 526  | 20   | 22,5  | 83,58 | 2  |

| Code   | mm             | L mm | E mm | E1 mm | €     |   |
|--------|----------------|------|------|-------|-------|---|
| 190050 | 1/4"x5/16"     | 170  | 4,9  | 5,6   | 7,03  | 1 |
| 190052 | 5/16"x3/8"     | 190  | 6    | 7,4   | 7,69  | 1 |
| 190054 | 3/8"x7/16"     | 197  | 7,4  | 7,9   | 8,21  | 1 |
| 190056 | 7/16"x1/2"     | 213  | 8,4  | 8,9   | 8,68  | 1 |
| 190058 | 1/2"x9/16"     | 228  | 9,4  | 9,9   | 9,42  | 1 |
| 190060 | 9/16"x5/8"     | 246  | 10,4 | 10,9  | 10,52 | 1 |
| 190062 | 5/8"x11/16"    | 246  | 10,4 | 10,9  | 11,19 | 1 |
| 190064 | 11/16"x3/4"    | 265  | 11,4 | 11,9  | 12,94 | 1 |
| 190066 | 3/4"x7/8"      | 288  | 12,4 | 12,9  | 14,05 | 1 |
| 190068 | 13/16"x7/8"    | 288  | 12,4 | 12,9  | 14,92 | 1 |
| 190070 | 13/16"x15/16"  | 310  | 13,1 | 13,7  | 16,85 | 1 |
| 190072 | 15/16"x1"      | 330  | 13,7 | 14,3  | 20,92 | 1 |
| 190074 | 1"x1-1/8"      | 348  | 14,2 | 14,7  | 24,30 | 1 |
| 190076 | 1-1/16"x1-1/4" | 372  | 15   | 16    | 25,79 | 1 |
| 190078 | 1-1/8"x1-1/4"  | 372  | 14,8 | 15,8  | 26,83 | 1 |

## Offset ring spanner set in carton box



### CONTENTS

191182: 8x9, 10x11, 12x13, 14x15, 16x17, 18x19 mm

191180: 6x7, 8x9, 10x11, 12x13, 14x15, 16x17, 18x19, 20x22 mm

| Code   | No. of Items | €     |   |
|--------|--------------|-------|---|
| 191182 | 6            | 58,14 | 2 |
| 191180 | 8            | 80,12 | 2 |

**Offset ring spanner set in nylon pouch**



**CONTENTS**  
**191181:** 6x7, 8x9, 10x11, 12x13, 14x15, 16x17, 18x19, 20x22 mm  
**190090:** 1/4"x5/16" • 5/16"x3/8" • 3/8"x7/16" • 7/16"x1/2" • 1/2"x9/16" • 5/8"x11/16" • 3/4"x7/8" • 11/16"x3/4"

| Code          | No. of Items | €            |   |
|---------------|--------------|--------------|---|
| <b>191181</b> | 8            | <b>80,50</b> | 1 |
| <b>190090</b> | 8            | <b>79,25</b> | 1 |

**CONTENTS**  
**191185:** 6x7, 8x9, 10x11, 12x13, 14x15, 16x17, 18x19, 20x22, 21x23, 24x27, 25x28, 30x32 mm  
**190095:** 1/4"x5/16" • 5/16"x3/8" • 3/8"x7/16" • 7/16"x1/2" • 1/2"x9/16" • 9/16"x5/8" • 5/8"x11/16" • 3/4"x7/8" • 13/16"x7/8" • 15/16"x1" • 1-1/16"x1-1/4" • 1-1/8"x1-1/4"

| Code          | No. of Items | €             |   |
|---------------|--------------|---------------|---|
| <b>191185</b> | 12           | <b>171,74</b> | 1 |
| <b>190095</b> | 12           | <b>165,29</b> | 1 |

**Offset ring spanner set in plastic holder**



**CONTENTS**  
 6x7, 8x9, 10x11, 12x13, 14x15, 16x17, 18x19, 20x22 mm

| Code          | No. of Items | €            |   |
|---------------|--------------|--------------|---|
| <b>191190</b> | 8            | <b>80,61</b> | 2 |

**Offset ring spanner set in plastic box**



Box dimensions: 255x185x48 mm



**CONTENTS**  
 6x7, 8x9, 10x11, 12x13, 14x15, 16x17, 18x19 mm

| Code          | No. of Items | €            |   |
|---------------|--------------|--------------|---|
| <b>191196</b> | 7            | <b>65,18</b> | 2 |

## Ring slogging wrench

DIN  
7444

Cr-V  
STEEL



Rounded  
edges

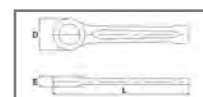

- 12-points box end with rounded corners
- Black finish

| Code   | mm | L mm | D mm | E mm | €     |   |
|--------|----|------|------|------|-------|---|
| 191370 | 24 | 168  | 43,4 | 14,8 | 16,84 | 1 |
| 191371 | 27 | 180  | 46   | 16   | 18,62 | 1 |
| 191372 | 30 | 190  | 51,5 | 17   | 22,06 | 1 |
| 191373 | 32 | 190  | 54   | 17   | 23,72 | 1 |
| 191374 | 36 | 205  | 58,5 | 18,5 | 27,42 | 1 |
| 191375 | 38 | 228  | 64,6 | 20,1 | 33,94 | 1 |
| 191376 | 41 | 230  | 65   | 20   | 37,24 | 1 |
| 191377 | 46 | 240  | 73,5 | 22   | 40,63 | 1 |
| 191378 | 50 | 253  | 78,5 | 24   | 48,10 | 1 |
| 191379 | 55 | 266  | 85   | 25   | 60,07 | 1 |

| Code   | mm  | L mm | D mm | E mm | €      |   |
|--------|-----|------|------|------|--------|---|
| 191381 | 60  | 280  | 92   | 26   | 70,34  | 1 |
| 191382 | 65  | 300  | 102  | 30   | 82,58  | 1 |
| 191383 | 70  | 330  | 110  | 33   | 107,82 | 1 |
| 191384 | 75  | 330  | 110  | 33   | 111,48 | 1 |
| 191385 | 80  | 340  | 118  | 34   | 146,80 | 1 |
| 191386 | 85  | 355  | 130  | 36   | 182,30 | 1 |
| 191387 | 90  | 390  | 142  | 39   | 219,67 | 1 |
| 191388 | 95  | 390  | 142  | 39   | 234,81 | 1 |
| 191389 | 100 | 420  | 155  | 43   | 348,34 | 1 |

## Open ended slogging wrench

DIN  
133

Cr-V  
STEEL

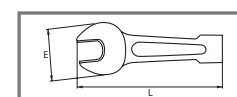
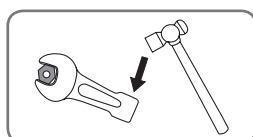

- Black finish

| Code   | mm | L mm | E mm | €      |   |
|--------|----|------|------|--------|---|
| 190824 | 24 | 177  | 52,5 | 15,96  | 1 |
| 190827 | 27 | 180  | 56   | 17,62  | 1 |
| 190830 | 30 | 190  | 62   | 20,65  | 1 |
| 190832 | 32 | 190  | 62   | 22,44  | 1 |
| 190836 | 36 | 215  | 74   | 26,17  | 1 |
| 190838 | 38 | 215  | 74   | 31,91  | 1 |
| 190841 | 41 | 235  | 86   | 34,71  | 1 |
| 190846 | 46 | 255  | 96   | 38,46  | 1 |
| 190850 | 50 | 275  | 105  | 45,29  | 1 |
| 190855 | 55 | 300  | 115  | 56,53  | 1 |
| 190860 | 60 | 320  | 126  | 66,39  | 1 |
| 190865 | 65 | 343  | 138  | 77,25  | 1 |
| 190870 | 70 | 375  | 154  | 101,86 | 1 |
| 190875 | 75 | 375  | 154  | 105,18 | 1 |
| 190880 | 80 | 400  | 174  | 137,01 | 1 |
| 190885 | 85 | 400  | 174  | 172,77 | 1 |

**Flat ring spanner**

**DIN 837**

**Cr-V STEEL**

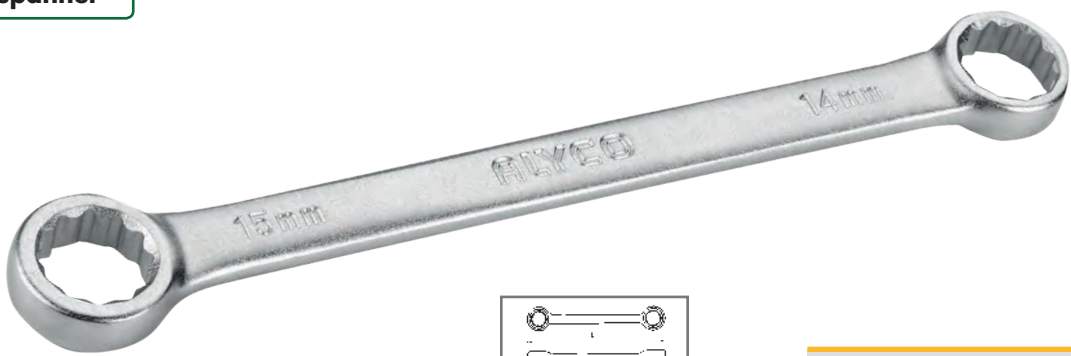

Rounded edges

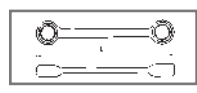

• Polished heads and satin finish

| Code          | mm    | L mm | €            |    |
|---------------|-------|------|--------------|----|
| <b>191305</b> | 6x7   | 120  | <b>6,02</b>  | 10 |
| <b>191310</b> | 8x9   | 135  | <b>6,66</b>  | 10 |
| <b>191315</b> | 10x11 | 155  | <b>6,81</b>  | 10 |
| <b>191320</b> | 12x13 | 165  | <b>7,39</b>  | 10 |
| <b>191325</b> | 14x15 | 180  | <b>8,22</b>  | 10 |
| <b>191330</b> | 16x17 | 210  | <b>9,28</b>  | 10 |
| <b>191335</b> | 18x19 | 225  | <b>10,14</b> | 10 |

| Code          | mm    | L mm | €            |   |
|---------------|-------|------|--------------|---|
| <b>191340</b> | 20x22 | 240  | <b>12,03</b> | 5 |
| <b>191345</b> | 21x23 | 255  | <b>14,36</b> | 5 |
| <b>191350</b> | 24x26 | 270  | <b>15,78</b> | 5 |
| <b>191355</b> | 25x28 | 280  | <b>17,67</b> | 5 |
| <b>191357</b> | 27x29 | 310  | <b>19,13</b> | 5 |
| <b>191360</b> | 30x32 | 330  | <b>20,55</b> | 5 |

**Flat ring spanners set in plastic holder**



**CONTENTS**  
6x7, 8x9, 10x11, 12x13, 14x15, 16x17, 18x19, 20x22 mm

| Code          | No. of Items | €            |   |
|---------------|--------------|--------------|---|
| <b>191398</b> | 8            | <b>68,25</b> | 2 |

**Flat ring spanners set in plastic case**



Box dimensions: 255x185x48 mm

**CONTENTS**  
6x7, 8x9, 10x11, 12x13, 14x15, 16x17, 18x19, 20x22 mm

| Code          | No. of Items | €            |   |
|---------------|--------------|--------------|---|
| <b>191396</b> | 8            | <b>66,57</b> | 2 |

**Flat ring spanners set in nylon pouch**



**CONTENTS**  
6x7, 8x9, 10x11, 12x13, 14x15, 16x17, 18x19, 20x22, 21x23, 24x26, 25x28, 30x32 mm

| Code          | No. of Items | €             |   |
|---------------|--------------|---------------|---|
| <b>191397</b> | 12           | <b>134,93</b> | 1 |

## Reversible offset ratchet ring wrench

Cr-V  
STEEL

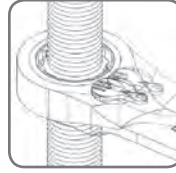

Ratcheting system that allows to work along thread bolts without removing the wrench

Ratchet handle of 72 teeth  
5°  
72T

Satin finish

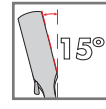

15° offset head

Both offset and reversible heads

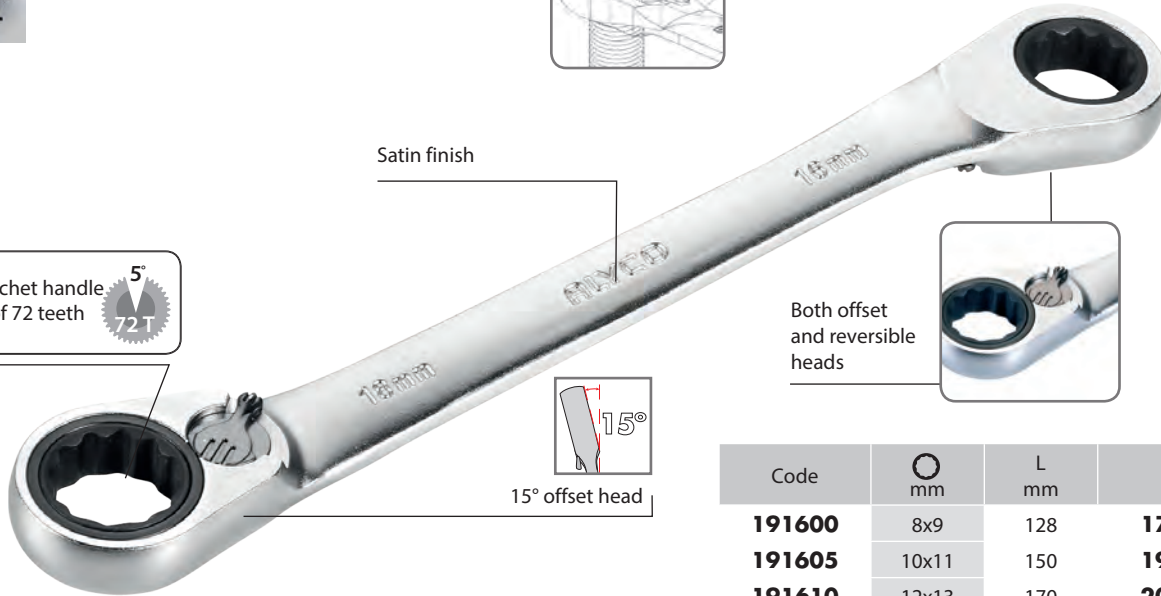

For adaptors see bottom of page

| Code          | mm    | L mm | €            |   |
|---------------|-------|------|--------------|---|
| <b>191600</b> | 8x9   | 128  | <b>17,87</b> | 5 |
| <b>191605</b> | 10x11 | 150  | <b>19,14</b> | 5 |
| <b>191610</b> | 12x13 | 170  | <b>20,33</b> | 5 |
| <b>191615</b> | 14x15 | 190  | <b>22,34</b> | 5 |
| <b>191620</b> | 16x18 | 230  | <b>25,56</b> | 5 |
| <b>191625</b> | 17x19 | 230  | <b>27,78</b> | 5 |

## Reversible offset ratchet ring wrench set in plastic case



Box dimensions: 255x185x48 mm



### CONTENTS

8x9, 10x11, 12x13, 14x15, 16x18, 17x19 mm.  
3 socket adaptors for 1/2" (191882), 1/4" (191880), 3/8" (191881)

| Code          | No. of Items | €             |   |
|---------------|--------------|---------------|---|
| <b>191650</b> | 9            | <b>133,40</b> | 1 |

## Adapters for sockets and insert bits



191882

191881

191880

191885

These 4 adapters are compatible to the ratchet wrenches of pages 82, 83, 84 and 85



| Code          | For sockets  | With spanner | €           |   |
|---------------|--------------|--------------|-------------|---|
| <b>191880</b> | Sockets 1/4" | 10           | <b>4,98</b> | 5 |
| <b>191881</b> | Sockets 3/8" | 13           | <b>5,53</b> | 5 |
| <b>191882</b> | Sockets 1/2" | 19           | <b>6,46</b> | 5 |
| <b>191885</b> | Bits 1/4"    | 10           | <b>1,88</b> | 5 |

### CONTENTS

191880 (1/4"), 191881 (3/8"), 191882 (1/2"), 191885 (sockets 1/4")

| Code          | No. of Items | €            |   |
|---------------|--------------|--------------|---|
| <b>191886</b> | 4            | <b>18,91</b> | 5 |

**Reversible offset ratchet combination wrench**

**Cr-V  
STEEL**



**For adaptors see page 82**

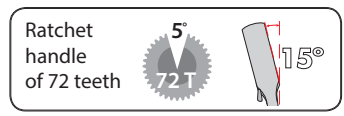

- 15° offset head
- Ratchet handle of 72 teeth
- Satin finish. Polished heads

| Code          | mm | L mm | €            |   |
|---------------|----|------|--------------|---|
| <b>191805</b> | 8  | 136  | <b>15,44</b> | 5 |
| <b>191810</b> | 9  | 143  | <b>15,52</b> | 5 |
| <b>191815</b> | 10 | 159  | <b>15,58</b> | 5 |
| <b>191820</b> | 11 | 168  | <b>16,03</b> | 5 |
| <b>191825</b> | 12 | 174  | <b>17,13</b> | 5 |
| <b>191830</b> | 13 | 180  | <b>18,83</b> | 5 |

| Code          | mm | L mm | €            |   |
|---------------|----|------|--------------|---|
| <b>191835</b> | 14 | 190  | <b>20,04</b> | 5 |
| <b>191840</b> | 15 | 200  | <b>20,53</b> | 5 |
| <b>191845</b> | 16 | 216  | <b>21,72</b> | 5 |
| <b>191850</b> | 17 | 233  | <b>22,82</b> | 5 |
| <b>191855</b> | 18 | 239  | <b>24,52</b> | 5 |
| <b>191860</b> | 19 | 248  | <b>25,15</b> | 5 |

| Code          | mm | L mm | €            |   |
|---------------|----|------|--------------|---|
| <b>191862</b> | 21 | 284  | <b>28,67</b> | 3 |
| <b>191864</b> | 22 | 284  | <b>30,35</b> | 3 |
| <b>191866</b> | 24 | 324  | <b>33,99</b> | 3 |
| <b>191868</b> | 27 | 359  | <b>47,72</b> | 2 |
| <b>191870</b> | 30 | 425  | <b>58,28</b> | 2 |
| <b>191872</b> | 32 | 425  | <b>63,01</b> | 2 |

**Reversible offset ratchet combination wrench in plastic holder**



**CONTENTS**  
8, 10, 11, 12, 13, 14, 17, 19 mm

| Code          | No. of Items | €             |   |
|---------------|--------------|---------------|---|
| <b>191876</b> | 8            | <b>151,02</b> | 2 |

**Reversible offset ratchet combination wrench set in plastic case**



**Socket and bit adaptors included**



**CONTENTS**  
• Ratchet combination wrenches: 8, 10, 12, 13, 15, 17, 18, 19 mm  
• 3 sockets adaptors for 1/4", 3/8" and 1/2"  
• 1 Adaptor for 1/4" bits

| Code          | No. of Items | €             |   |
|---------------|--------------|---------------|---|
| <b>191890</b> | 12           | <b>170,56</b> | 1 |

## Flexible ratchet combination wrench

Cr-V  
STEEL

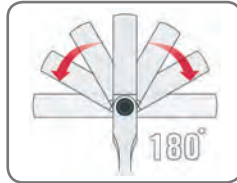

Swivel head. Possibility to rotate head to any angle from 0 to 180°

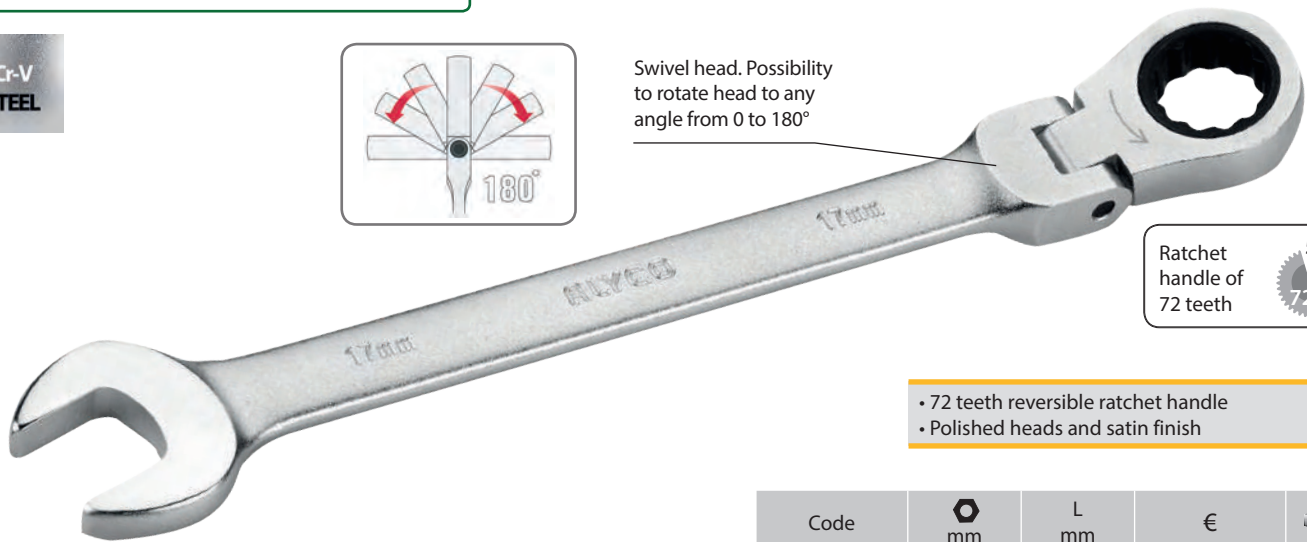

Ratchet handle of 72 teeth



- 72 teeth reversible ratchet handle
- Polished heads and satin finish

For adaptors see page 82

| Code          | mm | L mm | €            |   |
|---------------|----|------|--------------|---|
| <b>191905</b> | 8  | 136  | <b>16,98</b> | 5 |
| <b>191910</b> | 10 | 159  | <b>17,16</b> | 5 |
| <b>191915</b> | 11 | 168  | <b>17,62</b> | 5 |
| <b>191920</b> | 12 | 174  | <b>18,85</b> | 5 |
| <b>191925</b> | 13 | 180  | <b>20,70</b> | 5 |
| <b>191930</b> | 17 | 233  | <b>25,12</b> | 5 |
| <b>191935</b> | 19 | 248  | <b>27,65</b> | 5 |

## Flexible ratchet combination wrench in plastic holder



### CONTENTS

8, 10, 11, 12, 13, 14, 17, 19 mm

| Code          | No. of Items | €             |   |
|---------------|--------------|---------------|---|
| <b>191951</b> | 8            | <b>165,66</b> | 2 |

## Flexible ratchet combination wrench set



### CONTENTS

8, 10, 13, 17, 19 mm

| Code          | No. of Items | €             |   |
|---------------|--------------|---------------|---|
| <b>191950</b> | 5            | <b>107,61</b> | 1 |

**Stubby reversible offset ratchet combination wrench**

Cr-V  
STEEL



Specially designed short arm wrench for a better application in confined spaces



Ratchet handle of 72 teeth  
5°

For adaptors see page 82

- 15° offset head
- Ratchet handle of 72 teeth
- Polished heads and satin finish

| Code          | mm | L mm | €            |   |
|---------------|----|------|--------------|---|
| <b>191955</b> | 8  | 90   | <b>13,96</b> | 5 |
| <b>191960</b> | 10 | 95   | <b>14,11</b> | 5 |
| <b>191965</b> | 13 | 107  | <b>17,02</b> | 5 |
| <b>191970</b> | 17 | 126  | <b>20,64</b> | 5 |
| <b>191975</b> | 19 | 138  | <b>22,76</b> | 5 |

**Stubby reversible offset ratchet combination wrench set**



**CONTENTS**  
8, 10, 13, 17, 19 mm

| Code          | No. of Items | €            |   |
|---------------|--------------|--------------|---|
| <b>191980</b> | 5            | <b>88,50</b> | 1 |

**4-in-1 reversible ratchet wrench**

Cr-V  
STEEL

Ratchet handle of 72 teeth  
5°

Satin finish

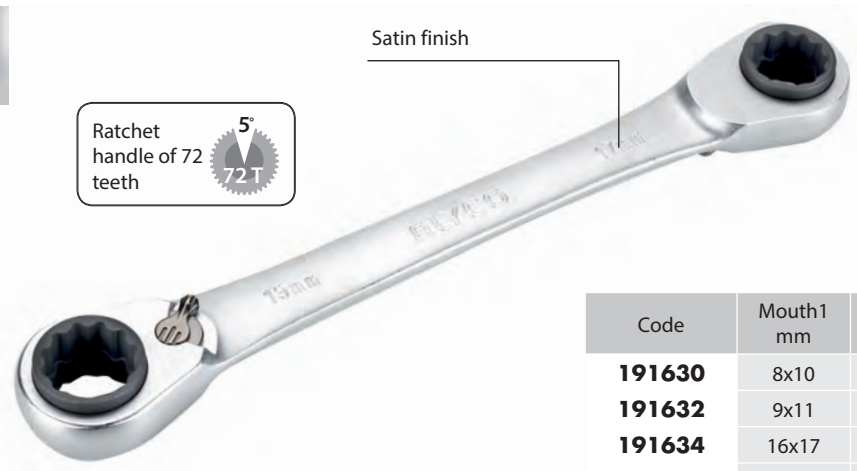

Each head can be used for two different screw sizes

| Code          | Mouth1 mm | Mouth2 mm | L mm | €            |   |
|---------------|-----------|-----------|------|--------------|---|
| <b>191630</b> | 8x10      | 12x13     | 160  | <b>19,03</b> | 2 |
| <b>191632</b> | 9x11      | 14x15     | 180  | <b>22,27</b> | 2 |
| <b>191634</b> | 16x17     | 18x19     | 225  | <b>23,61</b> | 2 |
| <b>191636</b> | 10x13     | 17x19     | 225  | <b>23,61</b> | 2 |

**4-in-1 ratchet wrench set, nylon pouch**



**CONTENTS**  
191630, 191632, 191634

| Code          | No. of Items | €            |   |
|---------------|--------------|--------------|---|
| <b>191640</b> | 3            | <b>65,53</b> | 1 |

## Insulated ratchet wrench

Cr-V  
STEEL



VDE certificate



### EN 60900 STANDARD

Insulated tools used for jobs on voltages of up to 1000 V in AC or up to 1500 V in DC.



• Ergonomic handle coated with non-slip material

| Code   | mm | L mm | €     |   |
|--------|----|------|-------|---|
| 190477 | 7  | 88   | 26,10 | 1 |
| 190478 | 8  | 104  | 27,12 | 1 |
| 190479 | 9  | 104  | 27,12 | 1 |
| 190480 | 10 | 114  | 27,73 | 1 |
| 190481 | 11 | 124  | 28,83 | 1 |
| 190482 | 12 | 124  | 28,83 | 1 |
| 190483 | 13 | 154  | 30,62 | 1 |
| 190484 | 14 | 154  | 30,62 | 1 |

| Code   | mm | L mm | €     |   |
|--------|----|------|-------|---|
| 190486 | 16 | 170  | 34,62 | 1 |
| 190487 | 17 | 170  | 34,62 | 1 |
| 190488 | 18 | 180  | 37,51 | 1 |
| 190489 | 19 | 180  | 37,51 | 1 |
| 190491 | 21 | 202  | 52,40 | 1 |
| 190492 | 22 | 202  | 52,40 | 1 |
| 190494 | 24 | 237  | 58,92 | 1 |

## Control cabin key



- 5-6-8 mm
- 9 mm
- ⊕ Insert bit PH2
- ▲ 9 mm
- Adapt. 1/4"
- ⊖ Slotted 4,5 mm



- 5-7-8 mm
- ▲ 4-10 mm
- ⊕ Insert bit PH2
- ▲ 10 mm
- Adapt. 1/4"
- ⊖ Slotted 4,5 mm

| Code   | Measure mm | €     |   |
|--------|------------|-------|---|
| 191990 | 60         | 13,90 | 6 |

Display with blister

| Code   | Measure mm | €     |   |
|--------|------------|-------|---|
| 191995 | 70         | 11,90 | 6 |

Display with blister

**Tubular forged socket wrench**

UNE  
16586

Cr-V  
STEEL

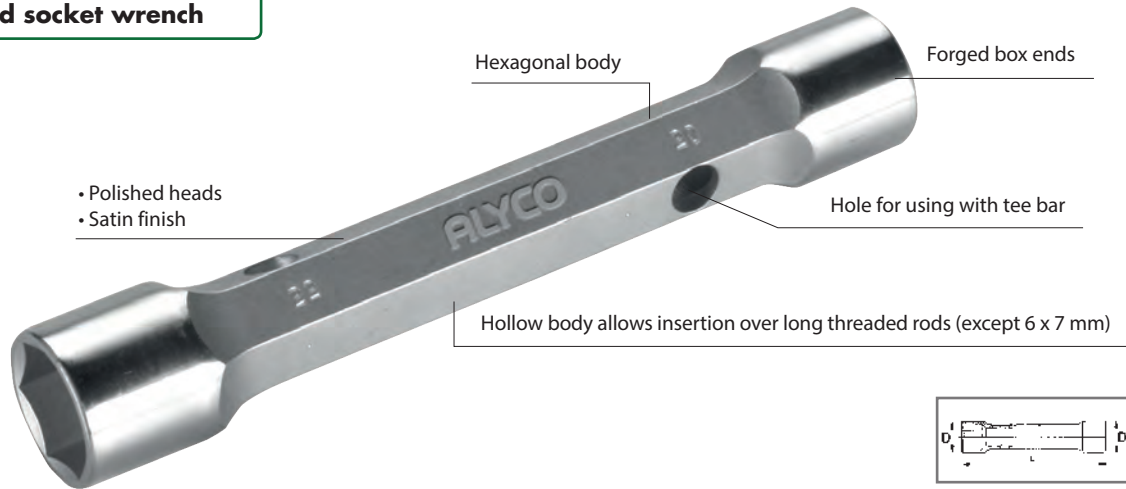

| Code          | Hex mm | L mm | D mm | D1 mm | €            | Image |
|---------------|--------|------|------|-------|--------------|-------|
| <b>191405</b> | 6x7    | 105  | 10   | 11    | <b>8,85</b>  | 10    |
| <b>191410</b> | 8x9    | 110  | 12,5 | 13,5  | <b>8,98</b>  | 10    |
| <b>191415</b> | 10x11  | 120  | 15   | 16    | <b>9,47</b>  | 10    |
| <b>191420</b> | 12x13  | 140  | 17,5 | 19    | <b>11,11</b> | 10    |
| <b>191425</b> | 14x15  | 145  | 20   | 21,5  | <b>12,35</b> | 10    |
| <b>191430</b> | 16x17  | 155  | 22,5 | 24    | <b>14,47</b> | 10    |
| <b>191435</b> | 18x19  | 165  | 25,5 | 26    | <b>17,34</b> | 10    |

| Code          | Hex mm | L mm | D mm | D1 mm | €            | Image |
|---------------|--------|------|------|-------|--------------|-------|
| <b>191440</b> | 20x22  | 175  | 28   | 30    | <b>19,79</b> | 5     |
| <b>191445</b> | 21x23  | 185  | 29   | 31    | <b>22,03</b> | 5     |
| <b>191450</b> | 24x26  | 195  | 32,5 | 36,5  | <b>23,57</b> | 5     |
| <b>191452</b> | 24x27  | 195  | 32,5 | 36,5  | <b>23,57</b> | 5     |
| <b>191455</b> | 25x28  | 205  | 34   | 37    | <b>26,44</b> | 5     |
| <b>191457</b> | 27x29  | 210  | 36   | 39    | <b>30,54</b> | 5     |
| <b>191460</b> | 30x32  | 210  | 40   | 42,5  | <b>34,70</b> | 5     |

Display with hanger

**Tubular forged socket wrench set in plastic holder**



**CONTENTS**

6x7, 8x9, 10x11, 12x13, 14x15, 16x17, 18x19 + tee-bar

| Code          | No. of Items | €            | Image |
|---------------|--------------|--------------|-------|
| <b>191485</b> | 8            | <b>84,87</b> | 1     |

**Tubular forged socket wrench set in plastic case**



Box dimensions: 255x185x48 mm

**CONTENTS**

6x7, 8x9, 10x11, 12x13, 14x15, 16x17, 18x19, 20x22 + tee-bar

| Code          | No. of Items | €             | Image |
|---------------|--------------|---------------|-------|
| <b>191480</b> | 9            | <b>107,21</b> | 1     |

**Tubular forged socket wrench set in nylon pouch**



**CONTENTS**

6x7, 8x9, 10x11, 12x13, 14x15, 16x17, 18x19, 20x22 mm + tee-bar

| Code          | No. of Items | €             | Image |
|---------------|--------------|---------------|-------|
| <b>191470</b> | 9            | <b>107,04</b> | 1     |



**CONTENTS**

6x7, 8x9, 10x11, 12x13, 14x15, 16x17, 18x19, 20x22, 21x23, 24x27, 25x28, 30x32 mm + two tee-bars

| Code          | No. of Items | €             | Image |
|---------------|--------------|---------------|-------|
| <b>191475</b> | 14           | <b>220,87</b> | 1     |

## Tubular socket spanner

DIN 896

Cr-V STEEL



- Tubular body and hexagonal shape of the head for using with spanners
- Satin finish
- Holes for using with tee bar

| Code   | mm    | L mm | €    |    |
|--------|-------|------|------|----|
| 191505 | 6x7   | 110  | 3,21 | 10 |
| 191510 | 8x9   | 110  | 3,36 | 10 |
| 191515 | 10x11 | 120  | 3,87 | 10 |
| 191520 | 12x13 | 140  | 4,61 | 10 |
| 191525 | 14x15 | 140  | 4,96 | 10 |
| 191530 | 16x17 | 150  | 5,35 | 10 |
| 191535 | 18x19 | 160  | 6,76 | 10 |
| 191540 | 20x22 | 170  | 8,60 | 5  |

| Code   | mm    | L mm | €     |   |
|--------|-------|------|-------|---|
| 191545 | 21x23 | 170  | 8,98  | 5 |
| 191550 | 24x26 | 190  | 12,10 | 5 |
| 191552 | 24x27 | 190  | 12,10 | 5 |
| 191555 | 25x28 | 190  | 13,11 | 5 |
| 191557 | 27x29 | 195  | 13,25 | 5 |
| 191560 | 30x32 | 210  | 13,49 | 5 |
| 191565 | 36x41 | 210  | 18,11 | 5 |

Display with hunger

## Tubular socket spanner set in nylon pouch



### CONTENTS

6x7, 8x9, 10x11, 12x13, 14x15, 16x17, 18x19, 20x22 mm + tee-bar

| Code   | No. of Items | €     |   |
|--------|--------------|-------|---|
| 191570 | 9            | 44,24 | 1 |



### CONTENTS

6x7, 8x9, 10x11, 12x13, 14x15, 16x17, 18x19, 20x22, 21x23, 24x27, 25x28, 30x32 mm + two tee-bars

| Code   | No. of Items | €     |   |
|--------|--------------|-------|---|
| 191575 | 14           | 91,14 | 1 |

## Reversible offset ratchet ring spanner



| Code   | mm    | L mm | €     |   |
|--------|-------|------|-------|---|
| 191710 | 7x8   | 108  | 12,72 | 3 |
| 191720 | 10x11 | 175  | 16,05 | 3 |
| 191730 | 12x13 | 175  | 20,29 | 3 |
| 191740 | 14x15 | 175  | 21,09 | 3 |
| 191750 | 16x18 | 203  | 22,81 | 3 |
| 191760 | 17x19 | 203  | 23,45 | 3 |

**Angled open-socket wrench 6x6**

UNE  
16594-2

Cr-V  
STEEL

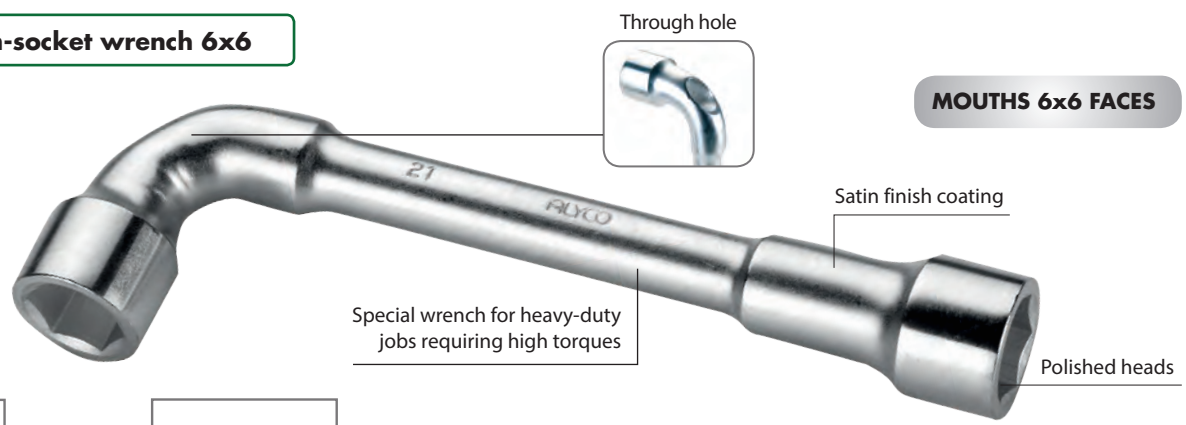

Special wrench for heavy-duty jobs requiring high torques

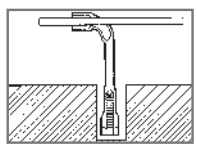

Allows use with nuts over threaded rods

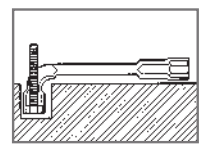

Rods can be used for high torque tightening

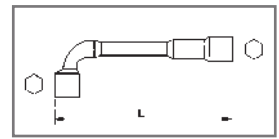

| Code   | mm | L mm | €     |   |
|--------|----|------|-------|---|
| 175001 | 6  | 105  | 8,66  | 5 |
| 175002 | 7  | 105  | 8,93  | 5 |
| 175003 | 8  | 115  | 9,87  | 5 |
| 175004 | 9  | 122  | 10,46 | 5 |
| 175005 | 10 | 130  | 11,06 | 5 |
| 175006 | 11 | 136  | 11,15 | 5 |
| 175007 | 12 | 145  | 11,91 | 5 |
| 175008 | 13 | 152  | 12,80 | 5 |
| 175009 | 14 | 160  | 13,63 | 5 |
| 175010 | 15 | 170  | 14,96 | 5 |
| 175011 | 16 | 178  | 16,34 | 5 |
| 175012 | 17 | 187  | 17,21 | 5 |
| 175013 | 18 | 195  | 18,31 | 5 |
| 175014 | 19 | 205  | 18,82 | 5 |

| Code   | mm | L mm | €     |   |
|--------|----|------|-------|---|
| 175015 | 20 | 212  | 20,53 | 5 |
| 175016 | 21 | 225  | 22,91 | 5 |
| 175017 | 22 | 225  | 24,52 | 5 |
| 175018 | 23 | 240  | 26,45 | 5 |
| 175019 | 24 | 250  | 26,83 | 1 |
| 175020 | 25 | 270  | 27,71 | 1 |
| 175021 | 26 | 270  | 35,27 | 1 |
| 175022 | 27 | 280  | 36,11 | 1 |
| 175023 | 28 | 290  | 37,59 | 1 |
| 175024 | 29 | 300  | 41,18 | 1 |
| 175025 | 30 | 310  | 46,87 | 1 |
| 175026 | 32 | 330  | 48,43 | 1 |
| 175027 | 36 | 355  | 65,35 | 1 |

**Angled open-socket wrench set in plastic holder**



**CONTENTS**  
10, 11, 12, 13, 17, 19 mm

| Code   | No. of Items | €     |   |
|--------|--------------|-------|---|
| 175030 | 6            | 83,25 | 1 |

**Tyre lever**

Cr-V  
STEEL

For disassembling  
tyres

- Chrome finish
- Curved to easy disassembly



| Code   | L mm | A mm | €     |   |
|--------|------|------|-------|---|
| 118050 | 215  | 16   | 5,24  | 1 |
| 118052 | 350  | 24   | 9,06  | 1 |
| 118054 | 500  | 28   | 15,51 | 1 |

## Offset handle

C-V  
STEEL

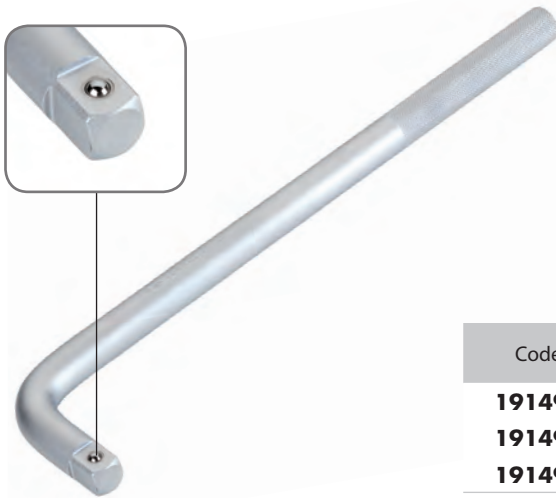

- Knurled handle
- Satin finish

| Code          | "   | L<br>mm | L<br>" | Ø<br>mm | €            |   |
|---------------|-----|---------|--------|---------|--------------|---|
| <b>191492</b> | 1/2 | 300     | 12     | 14      | <b>11,30</b> | 1 |
| <b>191494</b> | 3/4 | 300     | 12     | 20      | <b>19,56</b> | 1 |
| <b>191496</b> | 3/4 | 450     | 18     | 20      | <b>26,10</b> | 1 |

## Cross rim spanner

C-V  
STEEL

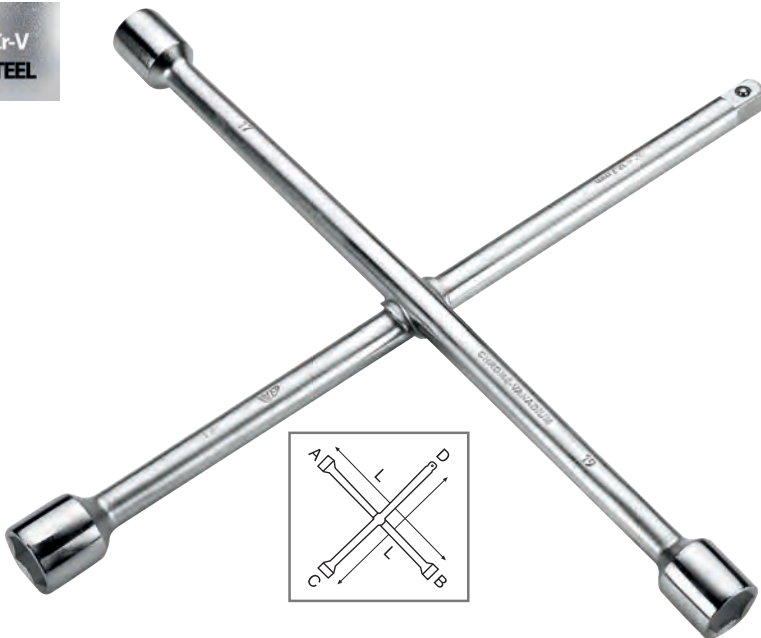

### MOUTH SIZES

| Code   | ØA<br>mm | ØB<br>mm | ØC<br>mm | D<br>" |
|--------|----------|----------|----------|--------|
| 191498 | 17       | 19       | 22       | 1/2    |
| 191499 | 24       | 27       | 32       | 3/4    |

- Hardened at 45 ÷ 50 HRC
- Polished heads and satin finish
- Strap welded. Particularly suitable for heavy-duty jobs

| Code          | L<br>mm | L<br>" | €            |   |
|---------------|---------|--------|--------------|---|
| <b>191498</b> | 375     | 15     | <b>31,19</b> | 1 |
| <b>191499</b> | 625     | 25     | <b>92,34</b> | 1 |

## Magnetic spark plug tee socket wrench

C-V  
STEEL

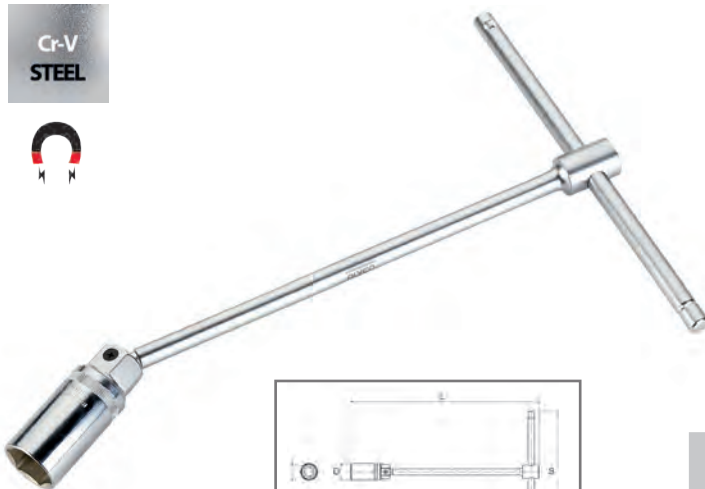

With 3/8" Dr. socket  
for use with  
ratchet handle

- Satin finish
- Magnetic 6-point socket
- Socket can be fixed at different angles

| Code          | mm | L<br>mm | S<br>mm | D<br>mm | €            |   |
|---------------|----|---------|---------|---------|--------------|---|
| <b>191695</b> | 16 | 300     | 200     | 22      | <b>21,61</b> | 1 |
| <b>191697</b> | 21 | 300     | 200     | 28      | <b>22,44</b> | 1 |

**Flexible socket wrench**

UNE  
16595

Cr-V  
STEEL



12-point rounded corners socket



- 12-point sockets
- Satin finish. Polished heads
- Socket can be tilted 180°

| Code          | mm    | L mm | D1 mm | D2 mm | €            |   |
|---------------|-------|------|-------|-------|--------------|---|
| <b>191652</b> | 6x7   | 182  | 9,5   | 11    | <b>12,78</b> | 2 |
| <b>191654</b> | 8x9   | 182  | 13    | 14    | <b>12,78</b> | 2 |
| <b>191656</b> | 10x11 | 198  | 15    | 16    | <b>13,15</b> | 2 |
| <b>191658</b> | 12x13 | 220  | 18    | 19    | <b>15,64</b> | 2 |
| <b>191660</b> | 14x15 | 240  | 20    | 22    | <b>17,57</b> | 2 |
| <b>191662</b> | 16x17 | 260  | 24    | 24    | <b>20,11</b> | 2 |
| <b>191664</b> | 18x19 | 275  | 26    | 26    | <b>23,37</b> | 2 |
| <b>191666</b> | 20x22 | 302  | 28    | 31    | <b>29,46</b> | 2 |
| <b>191668</b> | 21x23 | 307  | 29    | 33    | <b>30,75</b> | 2 |
| <b>191670</b> | 24x27 | 333  | 33    | 36,6  | <b>34,05</b> | 2 |
| <b>191672</b> | 30x32 | 349  | 39,7  | 41,7  | <b>39,13</b> | 2 |

**Flexible socket wrench set in nylon pouch**



**CONTENTS**

6x7, 8x9, 10x11, 12x13, 14x15, 16x17, 18x19, 20x22 mm

| Code          | No. of Items | €             |   |
|---------------|--------------|---------------|---|
| <b>191675</b> | 8            | <b>144,85</b> | 1 |

**Magnetic spark plug tee socket wrench**

DIN  
3112

Cr-V  
STEEL



With 3/8" Dr. socket for use with ratchet handle

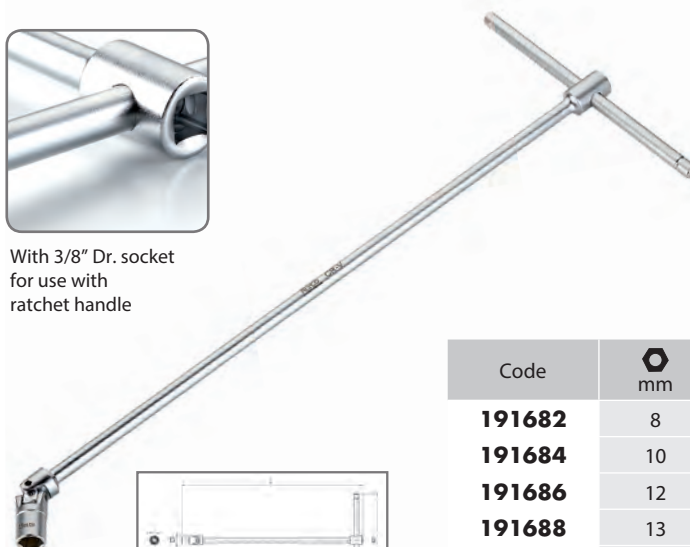

Universal joint



- 6 point socket
- Satin finish
- Socket can be fixed at different angles



| Code          | mm | L mm | S mm | D mm | €            |   |
|---------------|----|------|------|------|--------------|---|
| <b>191682</b> | 8  | 390  | 200  | 12,5 | <b>19,86</b> | 1 |
| <b>191684</b> | 10 | 500  | 200  | 15   | <b>21,05</b> | 1 |
| <b>191686</b> | 12 | 500  | 200  | 17,5 | <b>21,05</b> | 1 |
| <b>191688</b> | 13 | 500  | 200  | 18   | <b>21,05</b> | 1 |
| <b>191690</b> | 17 | 500  | 200  | 24   | <b>22,06</b> | 1 |
| <b>191692</b> | 19 | 500  | 200  | 26   | <b>23,47</b> | 1 |

## Side opening adjustable wrench

DIN 3117

Cr-V STEEL



Slim jaw for optimum access to limited and confined spaces

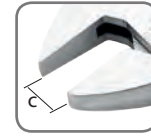

Wide jaw opening that exceeds DIN standard

Polished heads finish

Wide rounded handle

Both sides millimetered head for fast fittings

15°

15° angle wrench, aligns the wrench with the nut in a way that offers higher speed, precision and ergonomic handling



Side knurl opening system

| Code   | L mm | C mm | C (DIN) mm |
|--------|------|------|------------|
| 172270 | 150  | 23,9 | 19         |
| 172271 | 200  | 28,6 | 24         |
| 172272 | 250  | 32,8 | 28         |
| 172273 | 300  | 38,1 | 34         |
| 172274 | 400  | 50   | 43         |
| 172275 | 500  | 62   | 52         |

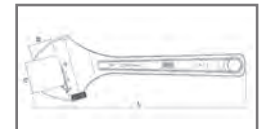

| Code          | L mm | L " | C mm | D mm | €             |   |
|---------------|------|-----|------|------|---------------|---|
| <b>172270</b> | 150  | 6   | 23,9 | 23   | <b>21,43</b>  | 6 |
| <b>172271</b> | 200  | 8   | 28,6 | 26,5 | <b>23,73</b>  | 6 |
| <b>172272</b> | 250  | 10  | 32,8 | 31   | <b>29,33</b>  | 6 |
| <b>172273</b> | 300  | 12  | 38,1 | 39   | <b>37,51</b>  | 6 |
| <b>172274</b> | 400  | 16  | 50   | 48   | <b>60,80</b>  | 4 |
| <b>172275</b> | 500  | 20  | 62   | 65   | <b>103,62</b> | 2 |

Display with hanger

## Standard adjustable wrench

DIN 3117

Cr-V STEEL



Graduated head in millimetres for quick adjustments

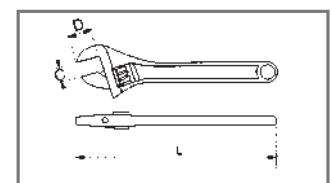

- Jaw opening depth higher than DIN standard.
- Graduated head for presettings.
- Satin finish.

| Code          | L mm | L " | C mm | D mm | €             |   |
|---------------|------|-----|------|------|---------------|---|
| <b>172250</b> | 150  | 6   | 20   | 18   | <b>14,91</b>  | 6 |
| <b>172251</b> | 200  | 8   | 24   | 25   | <b>17,28</b>  | 6 |
| <b>172252</b> | 250  | 10  | 29   | 29   | <b>21,62</b>  | 6 |
| <b>172253</b> | 300  | 12  | 34   | 32   | <b>27,88</b>  | 6 |
| <b>172254</b> | 380  | 16  | 43   | 44   | <b>50,36</b>  | 2 |
| <b>172255</b> | 450  | 18  | 53   | 53   | <b>76,07</b>  | 2 |
| <b>172256</b> | 600  | 24  | 70   | 62   | <b>147,05</b> | 1 |

Display with hanger



**Wide opening short adjustable wrench**

Cr-V  
STEEL

**30% LIGHTER**

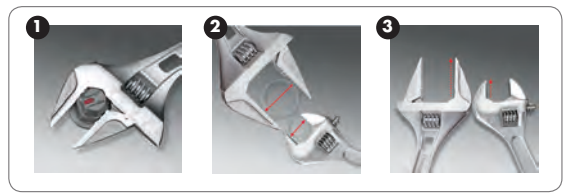

- 1 Prevents rounding of nuts
- 2 Large opening, 50% greater than DIN
- 3 Bigger depth of mouths

| Code          | L mm | L " | C mm | D mm | €            |   |
|---------------|------|-----|------|------|--------------|---|
| <b>172286</b> | 140  | 5,5 | 32   | 30   | <b>18,80</b> | 6 |
| <b>172288</b> | 160  | 6,3 | 43   | 41   | <b>24,40</b> | 6 |

Display with blister

**Extra wide opening adjustable wrench**

Cr-V  
STEEL

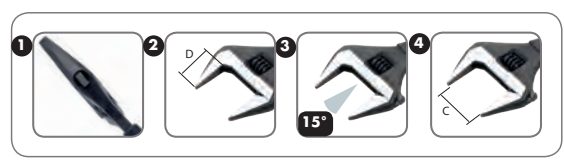
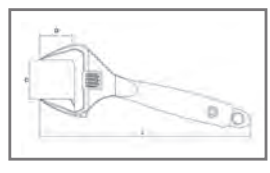

- 1 Extra thin head allows wrench to be used in limited and confined spaces. Torques easily exceeding DIN standards.
- 2 Deep throat, the height of jaw is higher than a general wrench in about 30%
- 3 Head angled at 15° for easier repositioning
- 4 Extra wide jaw opening. Over 55% wider than a standard wrench.

COMPARISON OF JAW OPENING AND JAW DEPTH

| Code   | C  | C (DIN) | D    | D (DIN) |
|--------|----|---------|------|---------|
| 172280 | 34 | 19      | 28,9 | 17,5    |
| 172281 | 38 | 24      | 32,4 | 22      |
| 172282 | 50 | 28      | 41   | 26      |
| 172283 | 60 | 34      | 55,7 | 29      |

Comparing to DIN values

| Code          | L mm | L " | C mm | D mm | €            |   |
|---------------|------|-----|------|------|--------------|---|
| <b>172280</b> | 150  | 6   | 34   | 29   | <b>19,69</b> | 6 |
| <b>172281</b> | 200  | 8   | 38   | 32   | <b>22,60</b> | 6 |
| <b>172282</b> | 250  | 10  | 50   | 41   | <b>27,94</b> | 5 |
| <b>172283</b> | 300  | 12  | 60   | 56   | <b>32,21</b> | 5 |

Display with blister

**Ratchet adjustable wrench**

DIN  
3117

Cr-V  
STEEL



Wrench function

- DOUBLE FUNCTION:**
- Standard. Lever to the left
  - Wrench. Lever to the right

| Code          | L mm | L " | C mm | D mm | €            |   |
|---------------|------|-----|------|------|--------------|---|
| <b>172277</b> | 200  | 8   | 28,6 | 26   | <b>23,26</b> | 3 |

Display with hanger

## Insulated adjustable wrench

DIN 3117

Cr-V STEEL



VDE certificate



- Handgrips covered with special insulating material
- Graduated head for presets
- Indelible marking

| Code          | L mm | L " | €            |   |
|---------------|------|-----|--------------|---|
| <b>172295</b> | 200  | 8   | <b>38,05</b> | 2 |
| <b>172296</b> | 250  | 10  | <b>42,13</b> | 2 |

## Hinged hook wrench

Cr-V STEEL

Each wrench valable for a range of diametres



- Forged hinged wrenches.
- Satin finish.

| Code          | N° | Ø mm    | L mm | €            |   |
|---------------|----|---------|------|--------------|---|
| <b>145101</b> | 0  | 15-35   | 168  | <b>21,08</b> | 6 |
| <b>145102</b> | 1  | 35-50   | 202  | <b>22,95</b> | 6 |
| <b>145103</b> | 2  | 50-80   | 280  | <b>31,49</b> | 6 |
| <b>145104</b> | 3  | 80-120  | 345  | <b>40,81</b> | 4 |
| <b>145105</b> | 4  | 120-180 | 492  | <b>56,13</b> | 2 |

## Hinged pin wrench

Cr-V STEEL

Each wrench valable for a range of diametres



- Forged hinged wrenches.
- Satin finish.

| Code          | N° | Ø mm    | L mm | D mm | €            |   |
|---------------|----|---------|------|------|--------------|---|
| <b>145106</b> | 0  | 15-35   | 168  | 3    | <b>22,51</b> | 6 |
| <b>145107</b> | 1  | 35-50   | 202  | 4    | <b>24,88</b> | 6 |
| <b>145108</b> | 2  | 50-80   | 280  | 5    | <b>32,40</b> | 6 |
| <b>145109</b> | 3  | 80-120  | 345  | 6    | <b>43,49</b> | 4 |
| <b>145110</b> | 4  | 120-180 | 492  | 8    | <b>58,20</b> | 2 |

## Spare pin for hinged pin wrenches



| Code          | N° | D mm | €           |   |
|---------------|----|------|-------------|---|
| <b>164021</b> | 0  | 3    | <b>2,70</b> | 6 |
| <b>164022</b> | 1  | 4    | <b>3,10</b> | 6 |
| <b>164023</b> | 2  | 5    | <b>3,84</b> | 6 |
| <b>164024</b> | 3  | 6    | <b>4,24</b> | 6 |
| <b>164025</b> | 4  | 8    | <b>5,21</b> | 6 |



**Torque wrench with display**  
**DIN 6789** Torque accuracy  $\pm 3\%$



**Certificate of Individual calibration**

Head and inner mechanism manufactured in CR-V Steel



Display with double scale N.m / Lb.Ft

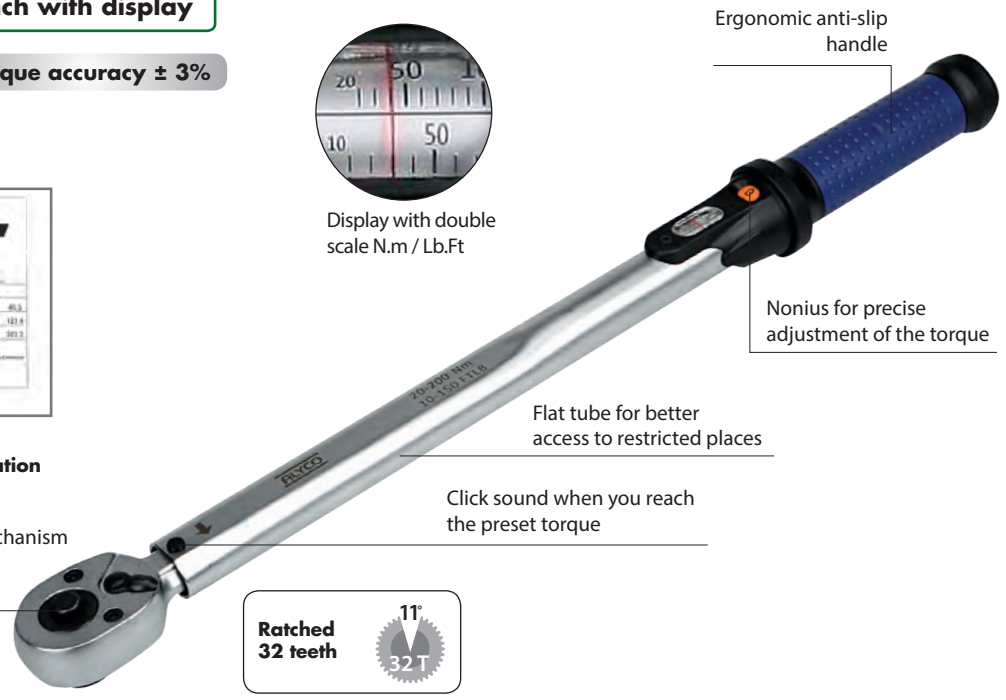

Ergonomic anti-slip handle

Nonius for precise adjustment of the torque

Flat tube for better access to restricted places

Click sound when you reach the preset torque



Setting lock



Ratched 32 teeth



Delivered in individual case

| Code          | "   | Nm     | Capacity Kgm | Lb-ft  | L mm | Graduation Nm | €             |   |
|---------------|-----|--------|--------------|--------|------|---------------|---------------|---|
| <b>192920</b> | 1/4 | 2-25   | 0,2-2,5      | 1,5-18 | 300  | 0,1           | <b>131,28</b> | 1 |
| <b>192930</b> | 3/8 | 5-50   | 0,5-5        | 3,5-37 | 330  | 0,25          | <b>147,75</b> | 1 |
| <b>192898</b> | 1/2 | 10-100 | 1-10         | 8-75   | 400  | 0,5           | <b>153,12</b> | 1 |
| <b>192900</b> | 1/2 | 20-200 | 2-20         | 10-150 | 500  | 1             | <b>163,32</b> | 1 |
| <b>192910</b> | 1/2 | 60-300 | 6-30         | 45-220 | 635  | 1             | <b>211,13</b> | 1 |

**3/4 "Torque Wrench**

**DIN 6789** Torque accuracy  $\pm 3\%$

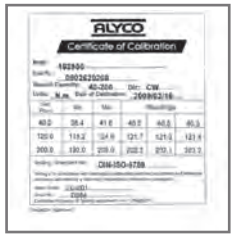

**Certificate of Individual calibration**

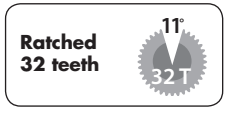

Ratched 32 teeth

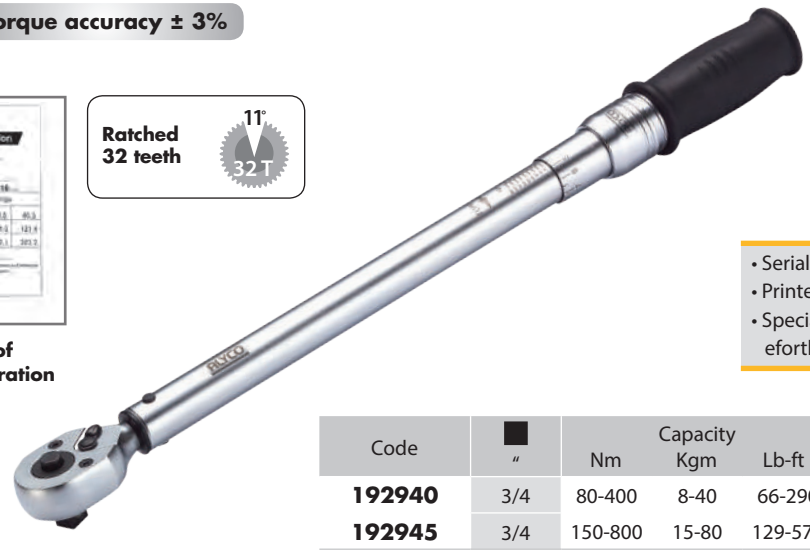

Delivered in individual case

- Serial number and certificate of individual calibration
- Printed scale of N.m / Lb.Ft.
- Special design for quick adjustment and effortless torque tightening

| Code          | "   | Nm      | Capacity Kgm | Lb-ft   | L mm | Graduation Nm | €             |   |
|---------------|-----|---------|--------------|---------|------|---------------|---------------|---|
| <b>192940</b> | 3/4 | 80-400  | 8-40         | 66-290  | 610  | 2,0           | <b>413,47</b> | 1 |
| <b>192945</b> | 3/4 | 150-800 | 15-80        | 129-572 | 1250 | 5,0           | <b>612,36</b> | 1 |

## Mini torque wrench

DIN 6789

Torque accuracy  $\pm 3\%$



Graduated scale N.m and Lb-F



Certificate of Individual calibration

| Code          | "   | Capacity Nm | Kgm     | L mm | Graduation Nm | €             |   |
|---------------|-----|-------------|---------|------|---------------|---------------|---|
| <b>192895</b> | 1/4 | 1-6         | 0.1-0.6 | 210  | 0,05          | <b>117,51</b> | 1 |

## Torque screwdriver

DIN 6789

Torque accuracy  $\pm 5\%$

HEX 1/4" FEMALE



192885

## High-Torque screwdriver

DIN 6789

Torque accuracy  $\pm 5\%$

HEX 1/4" FEMALE



192890

- Automatic adjustment knob
- Laser printed scale
- Anti-slip rubber ergonomic handle
- Certificate of individual calibration

| Code          | "   | Capacity cNm | Nm       | Graduation cNm | Nm   | €             |   |
|---------------|-----|--------------|----------|----------------|------|---------------|---|
| <b>192885</b> | 1/4 | 10-120       | 0,1-1,20 | 1              | 0,01 | <b>158,43</b> | 1 |
| <b>192890</b> | 1/4 | 100-600      | 1-6      | 10             | 0,1  | <b>167,08</b> | 1 |

Display in plastic case

## Angular torque gauge



- 360° angle scale marked in 2° increments
- Scale with plastic protector so to prevent dirt
- Adjustable bolt to keep fixed the scale

| Code          | Female                                   | Male                          | €            |   |
|---------------|--|-------------------------------|--------------|---|
| <b>192897</b> | 1/2" <input checked="" type="checkbox"/> | 1/2" <input type="checkbox"/> | <b>28,22</b> | 1 |

Display in blister

## Torque multiplier



Torque multiplication ratio 5:1



Includes extension bar and reaction arm

| Code          | Range in Nm | Range out Nm | Input                         | Output                                   | €             |   |
|---------------|-------------|--------------|-------------------------------|--|---------------|---|
| <b>192892</b> | 300         | 1500         | 1/2" <input type="checkbox"/> | 3/4" <input checked="" type="checkbox"/> | <b>677,00</b> | 1 |
| <b>192893</b> | 540         | 2700         | 3/4" <input type="checkbox"/> | 1" <input checked="" type="checkbox"/>   | <b>714,06</b> | 1 |

## Torque handle for interchangeable heads

- For heads of 9x12 and 14x18 mm
- Push-button for releasing the insert
- Ergonomic handle
- Quick and accurate adjustment of the torque



Printed scale N.m y Lb.Ft



Certificate of Individual calibration



Delivered in plastic case

| Code          | ∅ mm  | Capacity Kgm | Nm    | Graduation Nm | €             |   |
|---------------|-------|--------------|-------|---------------|---------------|---|
| <b>194100</b> | 9x12  | 4-20         | 0,4-2 | 0,1           | <b>127,25</b> | 1 |
| <b>194105</b> | 9x12  | 20-100       | 2-10  | 0,5           | <b>158,73</b> | 1 |
| <b>194110</b> | 14x18 | 40-200       | 4-20  | 1,0           | <b>162,52</b> | 1 |
| <b>194115</b> | 14x18 | 50-350       | 5-35  | 2,0           | <b>170,57</b> | 1 |

## Ratchet ended insert

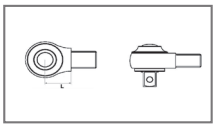

- Made of Chrome-Vanadium Steel
- Ratchet system with 72 teeth

| Code          | ∅ mm  | L mm | Head | €            |   |
|---------------|-------|------|------|--------------|---|
| <b>194180</b> | 9x12  | 46   | 1/4" | <b>29,94</b> | 1 |
| <b>194182</b> | 9x12  | 60   | 1/2" | <b>38,50</b> | 1 |
| <b>194184</b> | 14x18 | 70   | 1/2" | <b>39,63</b> | 1 |

## Open ended insert

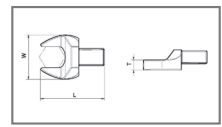

| Code          | ∅ mm  | ∅ mm | L x W x T mm | €            |   |
|---------------|-------|------|--------------|--------------|---|
| <b>194120</b> | 9x12  | 10   | 40x25x6      | <b>16,85</b> | 1 |
| <b>194121</b> | 9x12  | 11   | 40x25x6      | <b>16,85</b> | 1 |
| <b>194122</b> | 9x12  | 12   | 40x27x6      | <b>16,85</b> | 1 |
| <b>194123</b> | 9x12  | 13   | 40x29x6      | <b>16,85</b> | 1 |
| <b>194124</b> | 9x12  | 14   | 44x32x8      | <b>16,85</b> | 1 |
| <b>194127</b> | 9x12  | 17   | 44x38x8      | <b>18,18</b> | 1 |
| <b>194129</b> | 9x12  | 19   | 45x42x8      | <b>18,18</b> | 1 |
| <b>194133</b> | 14x18 | 13   | 58x30x7      | <b>21,03</b> | 1 |
| <b>194137</b> | 14x18 | 17   | 60x38x9      | <b>21,03</b> | 1 |
| <b>194139</b> | 14x18 | 19   | 60x41x9      | <b>21,03</b> | 1 |
| <b>194142</b> | 14x18 | 22   | 62x48x11     | <b>23,55</b> | 1 |
| <b>194144</b> | 14x18 | 24   | 64x51x11     | <b>27,05</b> | 1 |
| <b>194145</b> | 14x18 | 27   | 70x60x13,5   | <b>30,72</b> | 1 |
| <b>194146</b> | 14x18 | 30   | 71x64x13,5   | <b>30,72</b> | 1 |
| <b>194147</b> | 14x18 | 32   | 73x66x13,5   | <b>30,72</b> | 1 |
| <b>194148</b> | 14x18 | 36   | 75x68x13,5   | <b>30,72</b> | 1 |
| <b>194149</b> | 14x18 | 41   | 80x83x13,5   | <b>30,72</b> | 1 |

## Ring ended insert

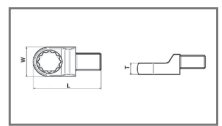

| Code          | ∅ mm  | ∅ mm | L x W x T mm | €            |   |
|---------------|-------|------|--------------|--------------|---|
| <b>194150</b> | 9x12  | 10   | 42x20x8      | <b>16,28</b> | 1 |
| <b>194151</b> | 9x12  | 11   | 44x21x8      | <b>16,28</b> | 1 |
| <b>194152</b> | 9x12  | 12   | 44x22x12,2   | <b>16,28</b> | 1 |
| <b>194153</b> | 9x12  | 13   | 44x22x12,2   | <b>16,28</b> | 1 |
| <b>194154</b> | 9x12  | 14   | 44x22x12,2   | <b>17,05</b> | 1 |
| <b>194157</b> | 9x12  | 17   | 48x28x13,2   | <b>17,05</b> | 1 |
| <b>194159</b> | 9x12  | 19   | 50x32x13,2   | <b>17,05</b> | 1 |
| <b>194163</b> | 14x18 | 13   | 60x30x12     | <b>20,37</b> | 1 |
| <b>194167</b> | 14x18 | 17   | 64x31x12,5   | <b>20,37</b> | 1 |
| <b>194169</b> | 14x18 | 19   | 66x31x12,5   | <b>20,37</b> | 1 |
| <b>194172</b> | 14x18 | 22   | 69x36x15     | <b>21,68</b> | 1 |
| <b>194174</b> | 14x18 | 24   | 69x38x15     | <b>21,68</b> | 1 |
| <b>194175</b> | 14x18 | 27   | 78x42x17,5   | <b>28,70</b> | 1 |
| <b>194176</b> | 14x18 | 30   | 78x45x17,5   | <b>28,70</b> | 1 |
| <b>194177</b> | 14x18 | 32   | 80x48x17,5   | <b>28,70</b> | 1 |
| <b>194178</b> | 14x18 | 36   | 83x54x19     | <b>30,95</b> | 1 |
| <b>194179</b> | 14x18 | 41   | 85x60x19     | <b>33,28</b> | 1 |



## 05 Keys



Multicolour  
key sets

99



Hexagonal key

100



Ball end key set

102



Folding  
hexagonal key set

103



Hexagonal  
T-handle

105



Insulated T  
handle

106



T-handle  
socket wrench

106



T-handle  
set

107

**Multicolour ball end hexagonal key set**

Cr-V  
STEEL  
S2



Anti-slip coating.  
Rough contact area  
on handgrip

**EXTRA-LONG TYPE**

Magnetic heads



Colour code



One piece  
rubber holder

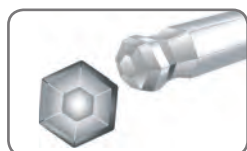

**DIAMOND SHAPED  
HEAD**

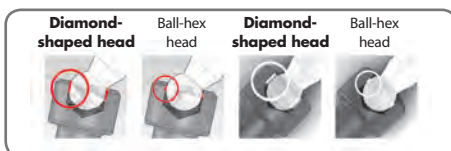

Greater contact surface with the screw because  
of special diamond-shaped profile.



**CONTENTS** 1'5, 2, 2'5, 3, 4, 5, 6, 8, 10 mm

| Code          | No. of Items | €            |   |
|---------------|--------------|--------------|---|
| <b>193145</b> | 9            | <b>21,37</b> | 6 |

**Display with blister**

**Multicolour coating ball end key**

Cr-V  
STEEL  
S2



**EXTRA-LONG TYPE**



Colour code



| Code          | mm  | L mm | €           |    |
|---------------|-----|------|-------------|----|
| <b>193171</b> | 1,5 | 92   | <b>1,07</b> | 10 |
| <b>193172</b> | 2   | 100  | <b>1,30</b> | 10 |
| <b>193182</b> | 2,5 | 115  | <b>1,39</b> | 10 |
| <b>193173</b> | 3   | 130  | <b>1,44</b> | 10 |
| <b>193174</b> | 4   | 145  | <b>1,72</b> | 10 |
| <b>193175</b> | 5   | 165  | <b>2,05</b> | 10 |
| <b>193176</b> | 6   | 186  | <b>3,15</b> | 10 |
| <b>193178</b> | 8   | 208  | <b>4,48</b> | 10 |
| <b>193181</b> | 10  | 234  | <b>6,73</b> | 10 |

**Display with blister**

**Multicolour hex key set**

Cr-V  
STEEL  
S2



**EXTRA-LONG TYPE**



Colour code

Same features as 193145



**CONTENTS** 1'5, 2, 2'5, 3, 4, 5, 6, 8, 10 mm

| Code          | No. of Items | €            |   |
|---------------|--------------|--------------|---|
| <b>193144</b> | 9            | <b>17,43</b> | 6 |

**Display with blister**

## Tamper-Proof Torx key set

Cr-V  
STEEL  
S2

EXTRA-LONG TYPE



Colour code

Same features as 193145



### CONTENTS

T10, T15, T20, T25, T27, T30, T40, T45, T50

| Code          | No. of Items | €            |   |
|---------------|--------------|--------------|---|
| <b>193148</b> | 9            | <b>31,52</b> | 6 |

Display with blister

## Hexagonal key

DIN  
2936

Cr-V  
STEEL



REGULAR SERIES

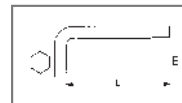

• Nickel coating



| Code          |      | L mm | E mm | €           |    |
|---------------|------|------|------|-------------|----|
| <b>190450</b> | 1/16 | 47   | 12   | <b>0,45</b> | 10 |
| <b>190451</b> | 5/64 | 50   | 16   | <b>0,47</b> | 10 |
| <b>190452</b> | 3/32 | 56   | 18   | <b>0,52</b> | 10 |
| <b>190453</b> | 1/8  | 63   | 20   | <b>0,60</b> | 10 |
| <b>190454</b> | 5/32 | 70   | 25   | <b>0,68</b> | 10 |
| <b>190455</b> | 3/16 | 80   | 28   | <b>0,82</b> | 10 |
| <b>190456</b> | 1/4  | 90   | 32   | <b>0,96</b> | 10 |
| <b>190457</b> | 5/16 | 100  | 36   | <b>1,29</b> | 10 |
| <b>190458</b> | 3/8  | 115  | 40   | <b>1,50</b> | 10 |

| Code          |     | L mm | E mm | €            |    |
|---------------|-----|------|------|--------------|----|
| <b>193015</b> | 1,5 | 47   | 12   | <b>0,45</b>  | 10 |
| <b>193002</b> | 2   | 50   | 16   | <b>0,47</b>  | 10 |
| <b>193025</b> | 2,5 | 56   | 18   | <b>0,52</b>  | 10 |
| <b>193003</b> | 3   | 63   | 20   | <b>0,60</b>  | 10 |
| <b>193004</b> | 4   | 70   | 25   | <b>0,68</b>  | 10 |
| <b>193005</b> | 5   | 80   | 28   | <b>0,82</b>  | 10 |
| <b>193006</b> | 6   | 90   | 32   | <b>0,96</b>  | 10 |
| <b>193007</b> | 7   | 95   | 34   | <b>1,29</b>  | 10 |
| <b>193008</b> | 8   | 100  | 36   | <b>1,50</b>  | 10 |
| <b>193009</b> | 9   | 105  | 38   | <b>1,97</b>  | 10 |
| <b>193010</b> | 10  | 112  | 40   | <b>2,02</b>  | 10 |
| <b>193012</b> | 12  | 125  | 45   | <b>3,04</b>  | 5  |
| <b>193014</b> | 14  | 140  | 56   | <b>4,25</b>  | 5  |
| <b>193017</b> | 17  | 160  | 63   | <b>6,88</b>  | 5  |
| <b>193019</b> | 19  | 180  | 70   | <b>10,32</b> | 5  |
| <b>193022</b> | 22  | 200  | 80   | <b>14,19</b> | 5  |

## Hexagonal key set in plastic holder

Cr-V  
STEEL

REGULAR SERIES



• Nickel coating  
• Hinged opening of plastic support



### CONTENTS

**193070** 1'5, 2, 2'5, 3, 4, 5, 6, 8, 10 mm

**193071** 1/16", 5/64", 3/32", 1/8", 5/32", 3/16", 1/4", 5/16", 3/8"

| Code          | No. of Items | €           |   |
|---------------|--------------|-------------|---|
| <b>193070</b> | 9            | <b>8,18</b> | 6 |
| <b>193071</b> | 9            | <b>8,18</b> | 1 |



**Hexagonal Key Set in Metal Ring**

Cr-V  
STEEL



**CONTENTS**  
**193055** 2, 2.5, 3, 4, 5, 6, 8 mm  
**193056** 1.5, 2, 2.5, 3, 4, 5, 6, 8, 10 mm

| Code          | No. of Items | €           |    |
|---------------|--------------|-------------|----|
| <b>193055</b> | 7            | <b>6,27</b> | 10 |
| <b>193056</b> | 9            | <b>7,94</b> | 10 |

Display in plastic bag

**Folding Hexagonal key set**

Cr-V  
STEEL



• Key unfolding system by lever



**CONTENTS** 1.5, 2, 2.5, 3, 4, 5, 6, 8 mm

| Code          | No. of Items | €            |    |
|---------------|--------------|--------------|----|
| <b>193082</b> | 8            | <b>12,69</b> | 12 |

Display with hanger

**Hexagonal key**

DIN  
2936

EXTRA-LONG TYPE

Cr-V  
STEEL

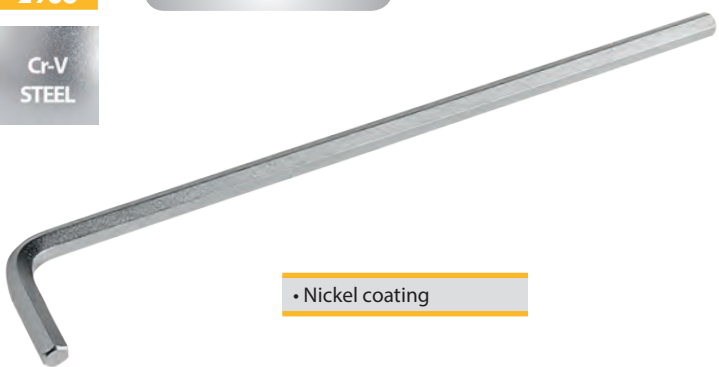

• Nickel coating

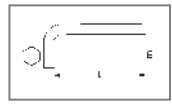

| Code          | mm  | L mm | E mm | €           |    |
|---------------|-----|------|------|-------------|----|
| <b>193902</b> | 2   | 100  | 14   | <b>0,62</b> | 10 |
| <b>193925</b> | 2.5 | 112  | 18   | <b>0,68</b> | 10 |
| <b>193903</b> | 3   | 126  | 20   | <b>0,86</b> | 10 |
| <b>193904</b> | 4   | 142  | 25   | <b>0,96</b> | 10 |
| <b>193905</b> | 5   | 160  | 28   | <b>1,17</b> | 10 |
| <b>193906</b> | 6   | 180  | 32   | <b>1,35</b> | 10 |
| <b>193907</b> | 7   | 190  | 34   | <b>2,09</b> | 10 |
| <b>193908</b> | 8   | 200  | 36   | <b>2,29</b> | 10 |
| <b>193910</b> | 10  | 224  | 40   | <b>3,25</b> | 10 |
| <b>193912</b> | 12  | 250  | 45   | <b>4,91</b> | 5  |
| <b>193914</b> | 14  | 280  | 55   | <b>5,95</b> | 5  |

**Hexagonal key set in plastic holder**

Cr-V  
STEEL

EXTRA-LONG TYPE

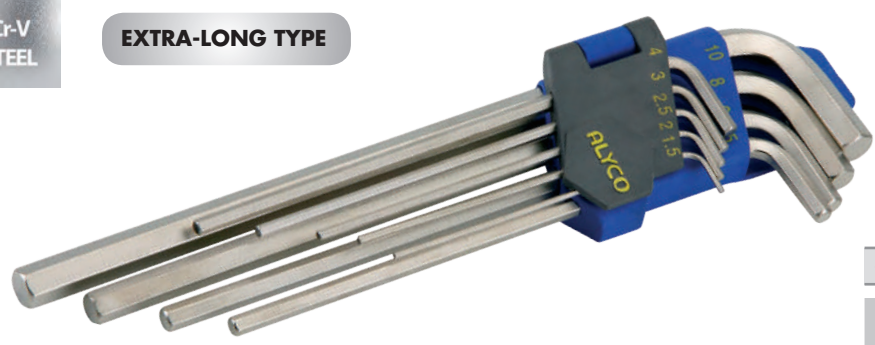

**CONTENTS** 1.5, 2, 2.5, 3, 4, 5, 6, 8, 10 mm

| Code          | No. of Items | €            |   |
|---------------|--------------|--------------|---|
| <b>193970</b> | 9            | <b>11,59</b> | 6 |

Display with blister

## Ball end hexagonal key

DIN 2936

EXTRA-LONG TYPE

Cr-V STEEL

Nickel coating

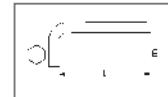

| Code   | mm   | L mm | E mm | €    |    |
|--------|------|------|------|------|----|
| 190460 | 1/16 | 85   | 12   | 1,10 | 10 |
| 190461 | 5/64 | 100  | 14   | 1,15 | 10 |
| 190462 | 3/32 | 112  | 18   | 1,21 | 10 |
| 190463 | 1/8  | 126  | 20   | 1,26 | 10 |
| 190464 | 5/32 | 142  | 25   | 1,50 | 10 |
| 190465 | 3/16 | 160  | 28   | 1,78 | 10 |
| 190466 | 1/4  | 180  | 32   | 2,74 | 10 |
| 190467 | 5/16 | 200  | 36   | 3,80 | 10 |
| 190468 | 3/8  | 224  | 40   | 6,64 | 10 |

| Code   | mm  | L mm | E mm | €     |    |
|--------|-----|------|------|-------|----|
| 193102 | 2   | 100  | 14   | 1,15  | 10 |
| 193125 | 2.5 | 112  | 18   | 1,21  | 10 |
| 193103 | 3   | 126  | 20   | 1,26  | 10 |
| 193104 | 4   | 142  | 25   | 1,50  | 10 |
| 193105 | 5   | 160  | 28   | 1,78  | 10 |
| 193106 | 6   | 180  | 32   | 2,74  | 10 |
| 193107 | 7   | 190  | 34   | 3,00  | 10 |
| 193108 | 8   | 200  | 36   | 3,90  | 10 |
| 193110 | 10  | 224  | 40   | 6,64  | 10 |
| 193112 | 12  | 250  | 45   | 7,14  | 5  |
| 193114 | 14  | 280  | 55   | 11,51 | 5  |

## Ball end hexagonal key set in plastic holder

Cr-V STEEL

EXTRA-LONG TYPE



### CONTENTS

193130 1'5, 2, 2'5, 3, 4, 5, 6, 8, 10 mm

193131 1/16', 5/64', 3/32', 1/8', 5/32', 3/16', 1/4', 5/16', 3/8"

| Code   | No. of Items | €     |   |
|--------|--------------|-------|---|
| 193130 | 9            | 15,00 | 6 |
| 193131 | 9            | 15,74 | 1 |



Display with blister

## Ball end hexagonal key set in plastic holder

Cr-V STEEL



### CONTENTS

1'5, 2, 2'5, 3, 4, 5, 6, 8, 10 mm

| Code   | No. of Items | €    |   |
|--------|--------------|------|---|
| 193140 | 9            | 9,07 | 6 |

Display with blister



**Torx key**

Cr-V  
STEEL

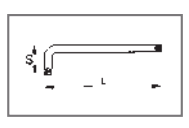

• Nickel coating



| Code          |  | L<br>mm | S<br>mm | €           |  |
|---------------|---|---------|---------|-------------|---|
| <b>193206</b> | T6  | 66      | 16      | <b>4,31</b> | 10  |
| <b>193207</b> | T7  | 71      | 16      | <b>4,31</b> | 10  |
| <b>193208</b> | T8  | 76      | 16      | <b>4,31</b> | 10  |
| <b>193209</b> | T9  | 80      | 16      | <b>4,36</b> | 10  |
| <b>193210</b> | T10   | 86      | 17      | <b>3,59</b> | 10  |
| <b>193215</b> | T15   | 90      | 18      | <b>3,66</b> | 10  |
| <b>193220</b> | T20   | 95      | 19      | <b>3,72</b> | 10  |
| <b>193225</b> | T25   | 100     | 20      | <b>3,76</b> | 10  |
| <b>193227</b> | T27   | 105     | 21      | <b>3,79</b> | 10  |
| <b>193230</b> | T30   | 114     | 24      | <b>3,84</b> | 10  |
| <b>193240</b> | T40   | 124     | 26      | <b>4,11</b> | 5   |
| <b>193245</b> | T45   | 137     | 29      | <b>4,28</b> | 5   |
| <b>193250</b> | T50   | 152     | 32      | <b>4,67</b> | 5   |
| <b>193255</b> | T55   | 171     | 35      | <b>6,33</b> | 5   |
| <b>193260</b> | T60   | 190     | 38      | <b>7,74</b> | 5   |

**Torx tapered key**

Cr-V  
STEEL



• Nickel coating

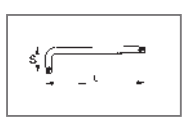

| Code          |  | L<br>mm | S<br>mm | €            |  |
|---------------|---|---------|---------|--------------|---|
| <b>194006</b> | T6  | 66      | 16      | <b>5,60</b>  | 10  |
| <b>194007</b> | T7  | 71      | 16      | <b>5,60</b>  | 10  |
| <b>194008</b> | T8  | 76      | 16      | <b>5,60</b>  | 10  |
| <b>194009</b> | T9  | 80      | 16      | <b>5,66</b>  | 10  |
| <b>194010</b> | T10   | 86      | 17      | <b>4,64</b>  | 10  |
| <b>194015</b> | T15   | 90      | 18      | <b>4,75</b>  | 10  |
| <b>194020</b> | T20   | 95      | 19      | <b>4,85</b>  | 10  |
| <b>194025</b> | T25   | 100     | 20      | <b>4,88</b>  | 10  |
| <b>194027</b> | T27   | 105     | 21      | <b>4,92</b>  | 10  |
| <b>194030</b> | T30   | 114     | 24      | <b>4,97</b>  | 10  |
| <b>194040</b> | T40   | 124     | 26      | <b>5,33</b>  | 5   |
| <b>194045</b> | T45   | 137     | 29      | <b>5,57</b>  | 5   |
| <b>194050</b> | T50   | 152     | 32      | <b>6,09</b>  | 5   |
| <b>194055</b> | T55   | 171     | 35      | <b>8,22</b>  | 5   |
| <b>194060</b> | T60   | 190     | 38      | <b>10,07</b> | 5   |

**Torx key set in plastic holder**

Cr-V  
STEEL



**CONTENTS**  
T10, T15, T20, T25, T27, T30, T40, T45, T50

| Code          | No. of Items | €            |  |
|---------------|--------------|--------------|---|
| <b>193270</b> | 9            | <b>16,09</b> | 6   |

Display with blister

**Torx tapered key set in plastic holder**

Cr-V  
STEEL



**CONTENTS**  
T10, T15, T20, T25, T27, T30, T40, T45, T50

| Code          | No. of Items | €            |  |
|---------------|--------------|--------------|---|
| <b>193290</b> | 9            | <b>19,20</b> | 6   |

Display with blister

## Torx tampered key set in plastic holder

Cr-V  
STEEL

EXTRA-LONG TYPE



**CONTENTS** T10, T15, T20, T25, T27, T30, T40, T45, T50

| Code          | No. of Items | €            |   |
|---------------|--------------|--------------|---|
| <b>193292</b> | 9            | <b>20,70</b> | 6 |

Display with blister

## Torx key set in plastic holder

Cr-V  
STEEL



**CONTENTS**  
T10, T15, T20, T25, T27, T30, T40

| Code          | No. of Items | €           |    |
|---------------|--------------|-------------|----|
| <b>193060</b> | 7            | <b>9,33</b> | 10 |

Display with blister

## Tamper-Proof Torx key set in plastic holder

Cr-V  
STEEL



**CONTENTS**  
T10, T15, T20, T25, T27, T30, T40

| Code          | No. of Items | €            |    |
|---------------|--------------|--------------|----|
| <b>193061</b> | 7            | <b>12,11</b> | 10 |

Display with blister

## Folding Torx key set

Cr-V  
STEEL



**CONTENTS**  
T6, T7, T8, T9, T10, T15, T20, T25

| Code          | No. of Items | €            |   |
|---------------|--------------|--------------|---|
| <b>193281</b> | 8            | <b>13,32</b> | 6 |

Display with blister

## Folding Tamper-Proof Torx key set

Cr-V  
STEEL



**CONTENTS**  
T9, T10, T15, T20, T25, T27, T30, T40

| Code          | No. of Items | €            |   |
|---------------|--------------|--------------|---|
| <b>193283</b> | 8            | <b>18,91</b> | 6 |

Display with blister

**Hexagonal T Handle**

Cr-V  
STEEL

**DIAMOND SHAPED  
HEAD**

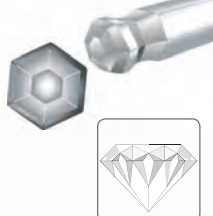

- Large ergonomic handle for high tightening torques
- With hole for hanging
- Satin finish coating

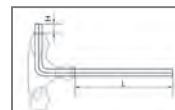

| Code          | mm  | H x L<br>mm | €            |   |
|---------------|-----|-------------|--------------|---|
| <b>195261</b> | 1,5 | 12x100      | <b>4,39</b>  | 6 |
| <b>195262</b> | 2   | 12x100      | <b>4,39</b>  | 6 |
| <b>195271</b> | 2,5 | 12x100      | <b>4,46</b>  | 6 |
| <b>195263</b> | 3   | 15x100      | <b>4,52</b>  | 6 |
| <b>195264</b> | 4   | 15x100      | <b>5,41</b>  | 6 |
| <b>195265</b> | 5   | 15x150      | <b>5,86</b>  | 6 |
| <b>195266</b> | 6   | 15x150      | <b>6,25</b>  | 6 |
| <b>195268</b> | 8   | 20x200      | <b>8,76</b>  | 6 |
| <b>195270</b> | 10  | 20x200      | <b>10,12</b> | 6 |

**Torx tampered T handle**

Cr-V  
STEEL

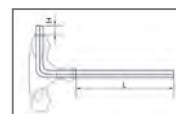

| Code          | mm  | H x L<br>mm | €            |   |
|---------------|-----|-------------|--------------|---|
| <b>195309</b> | T9  | 15x100      | <b>5,95</b>  | 6 |
| <b>195310</b> | T10 | 15x100      | <b>5,95</b>  | 6 |
| <b>195315</b> | T15 | 15x100      | <b>6,09</b>  | 6 |
| <b>195320</b> | T20 | 15x100      | <b>6,15</b>  | 6 |
| <b>195325</b> | T25 | 15x100      | <b>7,29</b>  | 6 |
| <b>195327</b> | T27 | 15x150      | <b>7,49</b>  | 6 |
| <b>195330</b> | T30 | 15x150      | <b>7,93</b>  | 6 |
| <b>195340</b> | T40 | 20x200      | <b>8,46</b>  | 6 |
| <b>195350</b> | T50 | 20x200      | <b>13,66</b> | 6 |

**Hexagonal T handle set**



**CONTENTS**

2, 2,5, 3, 4, 5, 6, 8, 10 mm

| Code          | No.<br>of Items | €            |   |
|---------------|-----------------|--------------|---|
| <b>195274</b> | 8               | <b>46,20</b> | 1 |

## Insulated hexagon T handle

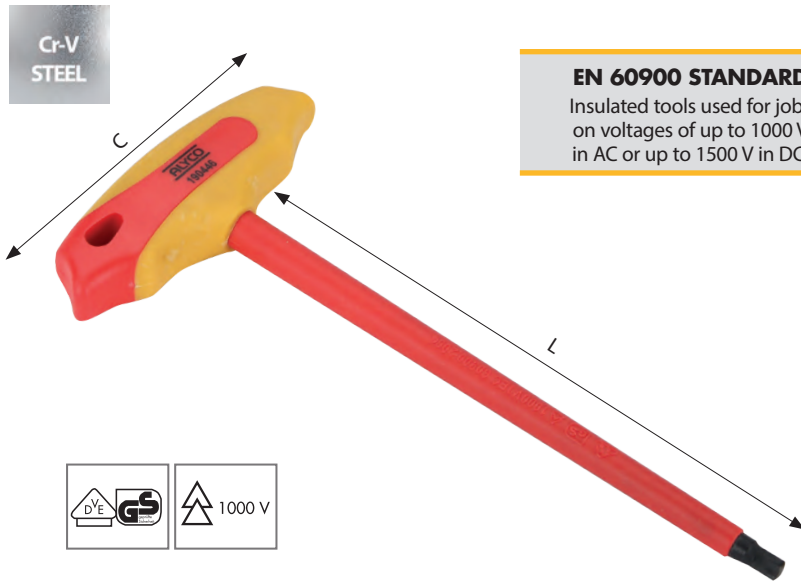

VDE certificate



| Code   | mm  | L x C mm | €     |   |
|--------|-----|----------|-------|---|
| 190442 | 2,5 | 100x80   | 8,06  | 6 |
| 190443 | 3   | 100x80   | 8,55  | 6 |
| 190444 | 4   | 125x100  | 10,77 | 6 |
| 190445 | 5   | 150x100  | 11,24 | 6 |
| 190446 | 6   | 175x120  | 13,16 | 6 |
| 190448 | 8   | 200x120  | 15,92 | 6 |

## T handle socket wrench

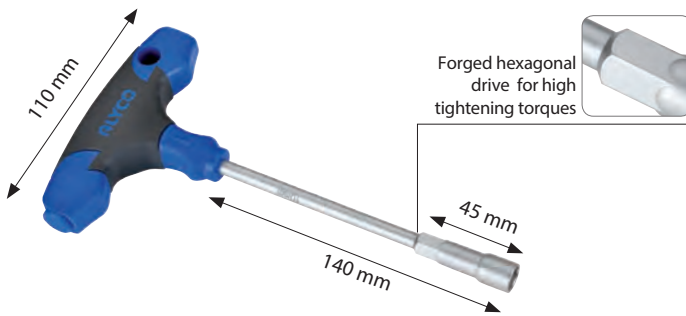

| Code   | mm  | €    |   |
|--------|-----|------|---|
| 195205 | 5   | 7,12 | 6 |
| 195255 | 5,5 | 7,12 | 6 |
| 195206 | 6   | 7,12 | 6 |
| 195207 | 7   | 7,12 | 6 |
| 195208 | 8   | 7,37 | 6 |
| 195209 | 9   | 7,37 | 6 |
| 195210 | 10  | 8,22 | 6 |
| 195211 | 11  | 8,22 | 6 |
| 195212 | 12  | 9,09 | 6 |
| 195213 | 13  | 9,09 | 6 |
| 195214 | 14  | 9,71 | 6 |

## T handle with deep socket wrench

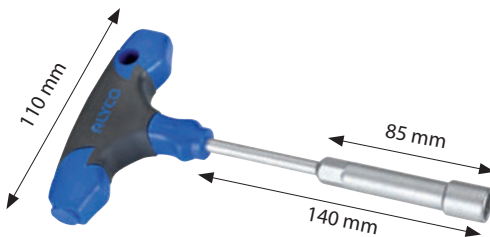

| Code   | mm | €     |   |
|--------|----|-------|---|
| 195227 | 7  | 8,19  | 6 |
| 195228 | 8  | 8,47  | 6 |
| 195230 | 10 | 9,47  | 6 |
| 195232 | 12 | 10,46 | 6 |
| 195233 | 13 | 10,46 | 6 |

## T handle with magnetic adaptor



| Code   | €    |   |
|--------|------|---|
| 195245 | 7,68 | 6 |

| Code   | €    |   |
|--------|------|---|
| 195250 | 8,63 | 6 |

| Code   | €    |    |
|--------|------|----|
| 195240 | 6,26 | 12 |

**T handle set with blades**

CR-V-MO  
STEEL



- Blade 125 mm long
- Ergonomic handle

**CONTENTS**

- 1 T handle
- 10 Double end blades: 1- / mm
- 1- / mm 1- / mm 1- / mm
- 1- / 1- / 1- /
- 1- / 1- / 1- /

| Code          | No. of Items | €            |   |
|---------------|--------------|--------------|---|
| <b>195284</b> | 11           | <b>21,95</b> | 1 |

**T handle set in nylon bag**



**CONTENTS**

- 8 Hexagonal T handle 1,5 - 2 - 2,5 - 3 - 4 - 5 - 6 - 8 mm
- 1 T handle magnetic adaptor
- 10 Bits 4, 5, 6 mm PH1, PH2 PZ1, PZ2 T10, T15, T20
- 1 1/4" socket holder

**Includes 20 different tips**

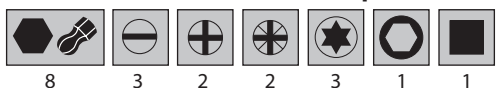

| Code          | No. of Items | €            |   |
|---------------|--------------|--------------|---|
| <b>195282</b> | 20           | <b>54,26</b> | 2 |

**13 in 1 nutdriver screwdriver set**

Cr-V  
STEEL



Tee-handle with  
3 ratchet positions

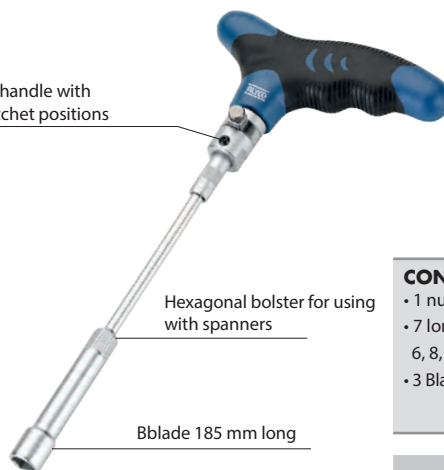

Hexagonal bolster for using  
with spanners

Bblade 185 mm long



**CONTENTS**

- 1 nutdriver with ratchet
- 7 long 1/4" sockets: 6, 8, 10, 11, 12, 13, 14 mm
- 3 Blades with double tip: PH1/PH2/PH3 4'5/5'5/6'5

| Code          | No. of Items | €            |   |
|---------------|--------------|--------------|---|
| <b>193470</b> | 11           | <b>54,34</b> | 1 |



## 06 Screwdrivers and bits



Insert bit

109



Magnetic bit holder

112



Bit set

113



Go through screwdriver

115



Screwdriver

116

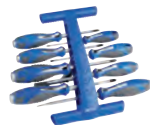

Screwdrivers set

118



Bit holding driver

120



Precision screwdriver

122



Insulated screwdriver

124



Insulated precision screwdriver

126



Polimeter

127



Tester

127

## BITS FEATURES

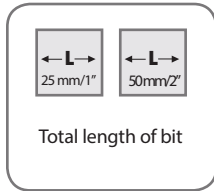

Total length of bit

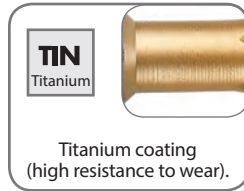

Titanium coating  
(high resistance to wear).

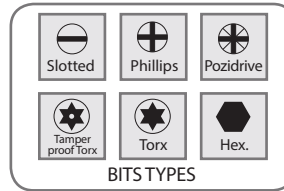

All 1/4" bits are supplied in plastic dispensers with lid

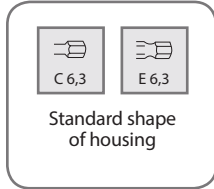

Standard shape of housing



### 1/4" bit 25 mm long

**DIN 3128**



| Code          | ⊕   | €           | 📦  |
|---------------|-----|-------------|----|
| <b>193536</b> | PH1 | <b>0,81</b> | 10 |
| <b>193537</b> | PH2 | <b>0,81</b> | 10 |
| <b>193538</b> | PH3 | <b>0,81</b> | 10 |

**DIN 3128**



| Code          | ⊕   | €           | 📦  |
|---------------|-----|-------------|----|
| <b>193546</b> | PH1 | <b>2,10</b> | 10 |
| <b>193547</b> | PH2 | <b>2,10</b> | 10 |
| <b>193548</b> | PH3 | <b>2,10</b> | 10 |



| Code          | ⊕   | €           | 📦  |
|---------------|-----|-------------|----|
| <b>193556</b> | PZ1 | <b>0,81</b> | 10 |
| <b>193557</b> | PZ2 | <b>0,81</b> | 10 |
| <b>193558</b> | PZ3 | <b>0,81</b> | 10 |



| Code          | ⊕   | €           | 📦  |
|---------------|-----|-------------|----|
| <b>193566</b> | PZ1 | <b>2,10</b> | 10 |
| <b>193567</b> | PZ2 | <b>2,10</b> | 10 |
| <b>193568</b> | PZ3 | <b>2,10</b> | 10 |

**DIN 3127**



\* Torsion bits

| Code          | ⬡    | €           | 📦  |
|---------------|------|-------------|----|
| <b>193570</b> | 1,5* | <b>0,92</b> | 10 |
| <b>193572</b> | 2*   | <b>0,92</b> | 10 |
| <b>193571</b> | 2,5* | <b>0,92</b> | 10 |
| <b>193573</b> | 3*   | <b>0,92</b> | 10 |
| <b>193574</b> | 4*   | <b>0,92</b> | 10 |
| <b>193575</b> | 5*   | <b>0,92</b> | 10 |
| <b>193576</b> | 6    | <b>0,92</b> | 10 |
| <b>193578</b> | 8    | <b>1,18</b> | 10 |
| <b>193580</b> | 10   | <b>1,34</b> | 10 |

## 1/4" bit 25 mm long

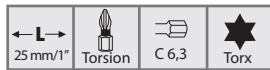

\*Torsion bits

| Code   | ★    | €    |    |
|--------|------|------|----|
| 193581 | T10* | 0,94 | 10 |
| 193582 | T15* | 0,94 | 10 |
| 193583 | T20* | 0,94 | 10 |
| 193584 | T25* | 0,94 | 10 |
| 193585 | T27* | 0,94 | 10 |
| 193586 | T30* | 0,94 | 10 |
| 193587 | T40  | 1,00 | 5  |
| 193588 | T45  | 1,19 | 5  |
| 193589 | T50  | 1,24 | 5  |
| 193603 | T55  | 1,27 | 5  |



| Code   | ★   | €    |    |
|--------|-----|------|----|
| 193590 | T10 | 1,05 | 10 |
| 193591 | T15 | 1,05 | 10 |
| 193592 | T20 | 1,05 | 10 |
| 193593 | T25 | 1,05 | 10 |
| 193594 | T27 | 1,05 | 10 |
| 193595 | T30 | 1,05 | 10 |
| 193596 | T40 | 1,05 | 5  |
| 193597 | T45 | 1,16 | 5  |
| 193598 | T50 | 1,23 | 5  |
| 193599 | T55 | 1,27 | 5  |

## DIN 3127



| Code   |           | €    |    |
|--------|-----------|------|----|
| 193503 | 0,6 x 4,5 | 1,00 | 10 |
| 193506 | 0,8 x 5,5 | 1,00 | 10 |
| 193511 | 1 x 5,5   | 1,00 | 10 |
| 193516 | 1,2 x 6,5 | 1,00 | 10 |
| 193521 | 1,6 x 8   | 1,00 | 10 |

## 1/4" bit 50 mm long

### DIN 3128

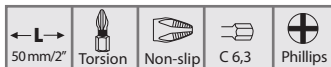

| Code   | ⊕   | €    |    |
|--------|-----|------|----|
| 193636 | PH1 | 1,98 | 10 |
| 193637 | PH2 | 1,98 | 10 |
| 193638 | PH3 | 1,98 | 10 |

### DIN 3128



| Code   | ⊕   | €    |    |
|--------|-----|------|----|
| 193646 | PH1 | 3,12 | 10 |
| 193647 | PH2 | 3,12 | 10 |
| 193648 | PH3 | 3,12 | 10 |

### DIN 3128



| Code   | ⊕   | €    |    |
|--------|-----|------|----|
| 193656 | PZ1 | 1,98 | 10 |
| 193657 | PZ2 | 1,98 | 10 |
| 193658 | PZ3 | 1,98 | 10 |

### DIN 3128



| Code   | ⊕   | €    |    |
|--------|-----|------|----|
| 193666 | PZ1 | 3,12 | 10 |
| 193667 | PZ2 | 3,12 | 10 |
| 193668 | PZ3 | 3,12 | 10 |

## 1/4" bit 50 mm long

DIN 3127



| Code   | mm        | €    |    |
|--------|-----------|------|----|
| 193601 | 0,6 x 4,5 | 2,51 | 10 |
| 193606 | 0,8 x 5,5 | 2,51 | 10 |
| 193611 | 1 x 5,5   | 2,51 | 10 |
| 193616 | 1,2 x 6,5 | 2,51 | 10 |
| 193621 | 1,6 x 8   | 2,51 | 10 |

## 1/4" bit 100 mm long

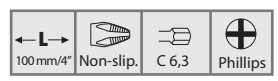

| Code   |     | €    |   |
|--------|-----|------|---|
| 193964 | PH1 | 3,93 | 6 |
| 193965 | PH2 | 3,93 | 6 |

## 1/4" bit 150 mm long

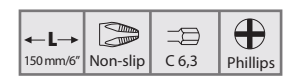

| Code   |     | €    |   |
|--------|-----|------|---|
| 193967 | PH1 | 5,03 | 6 |
| 193968 | PH2 | 5,03 | 6 |

## 5/16" bit 30 mm long



| SLOTTED |     |      |   |
|---------|-----|------|---|
| Code    | mm  | €    |   |
| 193935  | 5,5 | 1,63 | 5 |
| 193936  | 6,5 | 1,63 | 5 |
| 193938  | 8   | 1,63 | 5 |
| 193940  | 10  | 2,09 | 5 |
| 193942  | 12  | 2,93 | 5 |

| PHILLIPS |     |      |   |
|----------|-----|------|---|
| Code     |     | €    |   |
| 193961   | PH1 | 1,63 | 5 |
| 193962   | PH2 | 1,63 | 5 |
| 193963   | PH3 | 1,63 | 5 |

| POZIDRIVE |     |      |   |
|-----------|-----|------|---|
| Code      |     | €    |   |
| 193971    | PZ1 | 1,63 | 5 |
| 193972    | PZ2 | 1,63 | 5 |
| 193973    | PZ3 | 1,63 | 5 |

| HEXAGONAL |    |      |   |
|-----------|----|------|---|
| Code      | mm | €    |   |
| 193944    | 4  | 1,63 | 5 |
| 193945    | 5  | 1,63 | 5 |
| 193946    | 6  | 1,63 | 5 |
| 193948    | 8  | 1,63 | 5 |
| 193950    | 10 | 2,09 | 5 |
| 193952    | 12 | 2,93 | 5 |
| 193954    | 14 | 4,28 | 5 |

| TORX TAMPERED |     |      |   |
|---------------|-----|------|---|
| Code          |     | €    |   |
| 193990        | T20 | 2,09 | 5 |
| 193991        | T25 | 2,09 | 5 |
| 193992        | T27 | 2,09 | 5 |
| 193993        | T30 | 2,09 | 5 |
| 193994        | T40 | 2,09 | 5 |
| 193995        | T45 | 2,09 | 5 |
| 193996        | T50 | 2,09 | 5 |

| XZN    |     |      |   |
|--------|-----|------|---|
| Code   |     | €    |   |
| 193980 | M4  | 2,62 | 5 |
| 193981 | M5  | 2,62 | 5 |
| 193982 | M6  | 2,62 | 5 |
| 193983 | M8  | 2,62 | 5 |
| 193984 | M10 | 3,33 | 5 |
| 193985 | M12 | 4,80 | 5 |

## 3/8" bit 30 mm long



| Code   | ★   | €    | ☞  |
|--------|-----|------|----|
| 186123 | T20 | 2,09 | 10 |
| 186125 | T25 | 2,09 | 10 |
| 186130 | T30 | 2,09 | 10 |
| 186140 | T40 | 2,09 | 10 |
| 186145 | T45 | 2,09 | 10 |
| 186150 | T50 | 2,09 | 10 |
| 186155 | T55 | 2,09 | 10 |
| 186160 | T60 | 2,45 | 10 |



| Code   | mm | €    | ☞  |
|--------|----|------|----|
| 186104 | 4  | 1,63 | 10 |
| 186105 | 5  | 1,63 | 10 |
| 186106 | 6  | 1,63 | 10 |
| 186107 | 7  | 1,63 | 10 |
| 186108 | 8  | 1,63 | 10 |
| 186110 | 10 | 2,09 | 10 |
| 186112 | 12 | 2,45 | 10 |



| Code   | ☼   | €    | ☞  |
|--------|-----|------|----|
| 186165 | M5  | 2,62 | 10 |
| 186166 | M6  | 2,62 | 10 |
| 186168 | M8  | 2,62 | 10 |
| 186170 | M10 | 3,33 | 10 |
| 186172 | M12 | 4,85 | 10 |

## 3/8" bit 75 mm long



| Code   | ★   | €    | ☞  |
|--------|-----|------|----|
| 186124 | T20 | 2,85 | 10 |
| 186126 | T25 | 2,85 | 10 |
| 186131 | T30 | 2,85 | 10 |
| 186141 | T40 | 2,85 | 10 |
| 186146 | T45 | 2,85 | 10 |
| 186151 | T50 | 2,85 | 10 |
| 186156 | T55 | 2,85 | 10 |
| 186161 | T60 | 3,31 | 10 |



| Code   | mm | €    | ☞  |
|--------|----|------|----|
| 186114 | 4  | 2,85 | 10 |
| 186115 | 5  | 2,85 | 10 |
| 186116 | 6  | 2,85 | 10 |
| 186117 | 7  | 2,85 | 10 |
| 186118 | 8  | 2,85 | 10 |
| 186120 | 10 | 2,85 | 10 |
| 186122 | 12 | 3,31 | 10 |



| Code   | ☼   | €    | ☞  |
|--------|-----|------|----|
| 186175 | M5  | 2,85 | 10 |
| 186176 | M6  | 2,85 | 10 |
| 186178 | M8  | 2,85 | 10 |
| 186180 | M10 | 2,85 | 10 |
| 186182 | M12 | 3,31 | 10 |

## 1/4" magnetic bit holder



## 1/4" Magnetic bit holder set



| Code   | mm  | €    | ☞ |
|--------|-----|------|---|
| 194805 | 5,5 | 3,90 | 6 |
| 194806 | 6   | 3,90 | 6 |
| 194807 | 7   | 3,90 | 6 |
| 194808 | 8   | 3,90 | 6 |
| 194809 | 9   | 3,90 | 6 |
| 194810 | 10  | 4,30 | 6 |
| 194811 | 11  | 4,30 | 6 |
| 194812 | 12  | 4,30 | 6 |
| 194813 | 13  | 4,56 | 6 |

Display with hunger

CONTENTS 5'5, 6, 7, 8, 9, 10, 11, 12, 13 mm

| Code   | No. of Items | €     | ☞ |
|--------|--------------|-------|---|
| 194815 | 9            | 33,55 | 6 |

Display with blister

**1/4", 3/8" and 1/2" socket holder**



| Code          | ■    | L mm | €           |   |
|---------------|------|------|-------------|---|
| <b>193751</b> | 1/4" | 50   | <b>5,51</b> | 6 |
| <b>193752</b> | 3/8" | 50   | <b>5,97</b> | 6 |
| <b>193753</b> | 1/2" | 60   | <b>6,52</b> | 6 |

**Magnetic bit holder with quick release**



**1/4" bits set**

Cr-V  
STEEL  
S2



Colour code

**Magnetic bit holder**



| Code          | L mm | €            |   |
|---------------|------|--------------|---|
| <b>193740</b> | 50   | <b>4,68</b>  | 6 |
| <b>193742</b> | 100  | <b>7,43</b>  | 6 |
| <b>193744</b> | 150  | <b>10,08</b> | 6 |

Display packed with hanger

Not magnetized

| Code          | L mm | €           |   |
|---------------|------|-------------|---|
| <b>193750</b> | 60   | <b>9,82</b> | 6 |

Display packed with hanger



**Includes 12 different shapes of bits**

|   |   |   |   |    |   |
|---|---|---|---|----|---|
|   |   |   |   |    |   |
| 8 | 9 | 8 | 6 | 11 | 4 |
|   |   |   |   |    |   |
| 3 | 3 | 4 | 4 | 4  | 4 |

- CONTENTS**
- 59 Bits 1/4" 25 mm:
    - PZ1 (2), PZ2 (2), PZ3 (2)
    - PH1 (2), PH2 (2), PH3 (2)
    - T10, T15 (2), T20 (2), T25 (2), T27, T30
    - 4 (2), 5 (2), 6 (2), mm
    - 4 (2), 5 (2), 6 (2), mm
    - 0, 1, 2, 3
    - 6, 8, 10
    - 1, 2, 3
    - 4, 6, 8, 10
    - 4, 5, 6, 7
  - 9 bits 1/4" 75 mm
    - PZ1, PZ2
    - PH1, PH2, PH3
    - T20, T25
    - 4, 6 mm
  - 1 quick magnetic adapter
  - 1 magnetic adapter
  - 1 Y cup driver

| Code          | No. of Items | €            |   |
|---------------|--------------|--------------|---|
| <b>193730</b> | 71           | <b>30,24</b> | 3 |

Display with blister

## 1/4" bits set

Cr-V  
STEEL  
S2



Includes 6 different shapes of bits

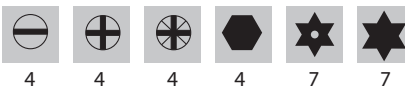

Colour code

### CONTENTS

- 30 Bits 1/4"
- PH1, PH2 (2), PH3
- PZ1, PZ2 (2), PZ3
- 3, 4, 5, 6 mm
- 3, 4, 5, 6 mm
- T10, T15, T20, T25, T27, T30, T40
- T10, T15, T20, T25, T27, T30, T40
- 1 Quick Magnetic Adapter
- 1 Magnetic Adapter 1/4"

| Code          | No. of Items | €            |   |
|---------------|--------------|--------------|---|
| <b>193725</b> | 32           | <b>16,40</b> | 6 |

Display with blister



## 3/8" bits set

Cr-V  
STEEL  
S2

SPECIAL AUTOMOTION



Includes 3 different shapes of bits



### CONTENTS

- 20 Bits 3/8" 30 mm:
  - Hex 4, 5, 6, 7, 8, 10, 12 mm
  - Xzn M5, M6, M8, M10, M12
  - Torx T20, T25, T30, T40, T45, T50, T55, T60
- 20 Bits 3/8" 75 mm:
  - Hex 4, 5, 6, 7, 8, 10, 12 mm
  - Xzn M5, M6, M8, M10, M12
  - Torx T20, T25, T30, T40, T45, T50, T55, T60
- 1 Adap. 3/8" H for bits 3/8"
- 1 Adap. 1/2" H for bits 3/8"

| Code          | No. of Items | €            |   |
|---------------|--------------|--------------|---|
| <b>186100</b> | 42           | <b>31,50</b> | 1 |

## Screwdriver set including ratchet handle and bits



Includes 5 different shapes of bits



Including magnetic adapter of 100 mm for attaching the screwdriver handle

### CONTENTS

- 48 Bits 1/4" 25 mm:
  - 3(1), 4(2), 5(2), 6(2), 7(1) mm
  - PH0(2), PH1(2), PH2(2), PH3(2)
  - PZ0(2), PZ1(2), PZ2(2), PZ3(2)
  - T8, T10, T15, T20, T25, T27, T30, T40
  - T8, T10, T15, T20, T25, T27, T30, T40
  - 1'5, 2, 2'5, 3, 4, 5, 5'5, 6 mm
- 32 bits 1/4" 50 mm
  - 3, 4, 5, 6(4), 7 mm
  - PH1, PH2(2), PH3
  - PZ1, PZ2(2), PZ3
  - T10, T15(2), T20(2), T25(2), T27, T30, T40
  - 2'5, 3, 4, 5, 5'5, 6 mm
- 1 Hook bit of 1/4"
- 1 Ratchet screwdriver handle
- 10 1/4" sockets: 4, 5, 6, 7, 8, 9, 10, 11, 12, 13 mm
- 1 Magnetic bit driver 100 mm
- 1 Quick magnetic adaptor 60 mm
- 1 Socket holder 1/4" 50 mm
- 1 1/4" bit adaptor

| Code          | No. of Items | €            |   |
|---------------|--------------|--------------|---|
| <b>119150</b> | 96           | <b>55,93</b> | 1 |

**Go-through screwdriver**

Cr-V  
STEEL  
S2



Hexagonal shaft.  
Special S2 steel (very  
high wear resistance)

4 different material handle



Striking cap with 8  
mm hexagonal hole

Black magnetic tip

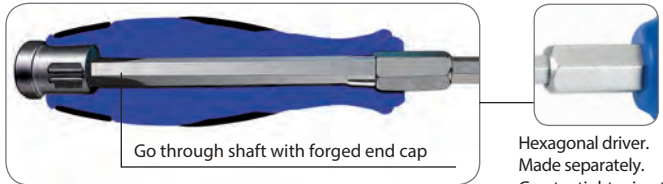

Go through shaft with forged end cap

Hexagonal driver.  
Made separately.  
Greater tightening torque.

| SLOTTED TIP   |         |         |     |             |    |
|---------------|---------|---------|-----|-------------|----|
| Code          | Ø<br>mm | Ø<br>mm | mm  | €           |    |
| <b>119205</b> | 5,5     | 1,0     | 125 | <b>6,44</b> | 12 |
| <b>119206</b> | 6,5     | 1,2     | 150 | <b>7,14</b> | 12 |
| <b>119208</b> | 8,0     | 1,2     | 150 | <b>8,55</b> | 12 |

Display with hanger

**Phillips tip**

Cr-V  
STEEL  
S2



| Code          | +   | mm  | €           |    |
|---------------|-----|-----|-------------|----|
| <b>119231</b> | PH1 | 100 | <b>5,72</b> | 12 |
| <b>119232</b> | PH2 | 150 | <b>6,88</b> | 12 |

Display with hanger

**Pozidrive tip**

Cr-V  
STEEL  
S2



| Code          | +   | mm  | €           |    |
|---------------|-----|-----|-------------|----|
| <b>119241</b> | PZ1 | 100 | <b>6,30</b> | 12 |
| <b>119242</b> | PZ2 | 150 | <b>7,56</b> | 12 |

Display with hanger

**Go-through screwdriver set**



| CONTENTS  |   |   |   |
|---|---|---|---|
| • Striking Cap • Hexagonal driver • Hexagonal shaft                       |   |   |   |
| Go through  | ⊖ | 5,5 x 100 mm / 6,5 x 125 mm Slotted tip | P |
|   | + | 1 x 80 mm / PH2 x 100 mm                |   |
|   | + | PZ1 x 80 mm / PZ2 x 100 mm              |   |
|   | ⊖ | 3 x 75 mm* / 4 x 80 mm (Cabinet tip)*   |   |
| *No end cap, hexagonal driver or hexagonal shaft. With cylindrical shaft. |   |   |   |

| Code          | No. of Items | €            |   |
|---------------|--------------|--------------|---|
| <b>119200</b> | 8            | <b>47,16</b> | 1 |

## Slotted tip screwdriver

DIN 5265

Cr-V STEEL S2

- Satin chrome finish
- Extra big handle for a better ergonomomy
- Upper end with type symbol



| Code          | Ø mm  | Ø mm | → mm | €           | ☞  |
|---------------|-------|------|------|-------------|----|
| <b>119004</b> | 4,0*  | 0,8  | 80   | <b>3,43</b> | 12 |
| <b>119005</b> | 5,5   | 1,0  | 125  | <b>4,36</b> | 12 |
| <b>119006</b> | 6,5   | 1,2  | 150  | <b>5,80</b> | 12 |
| <b>119008</b> | 8,0   | 1,2  | 150  | <b>6,91</b> | 12 |
| <b>119010</b> | 10,0* | 1,6  | 200  | <b>8,42</b> | 12 |

\* Screwdriver with cylindrical blade and without hexagon bolster

## Slotted electricians tip screwdriver

DIN 5265

Cr-V STEEL S2



With cylindrical blade without hexagon bolster

| Code          | Ø mm | Ø mm | → mm | €           | ☞  |
|---------------|------|------|------|-------------|----|
| <b>119022</b> | 2,5  | 0,4  | 75   | <b>2,75</b> | 12 |
| <b>119023</b> | 3,0  | 0,5  | 100  | <b>2,81</b> | 12 |
| <b>119024</b> | 4,0  | 0,8  | 100  | <b>3,45</b> | 12 |
| <b>119025</b> | 5,0  | 0,8  | 150  | <b>4,59</b> | 12 |

## Phillips tip screwdriver

DIN 5262

Cr-V STEEL S2



| Code          | ⊕    | → mm | €           | ☞  |
|---------------|------|------|-------------|----|
| <b>119030</b> | PH0* | 75   | <b>3,04</b> | 12 |
| <b>119031</b> | PH1  | 100  | <b>4,14</b> | 12 |
| <b>119029</b> | PH2  | 100  | <b>4,92</b> | 12 |
| <b>119032</b> | PH2  | 150  | <b>5,17</b> | 12 |
| <b>119033</b> | PH3  | 150  | <b>7,91</b> | 12 |

\* Screwdriver with cylindrical blade and without hexagon bolster

## Pozidrive tip screwdriver

DIN 5262

Cr-V STEEL S2



| Code          | ⊕    | → mm | €           | ☞  |
|---------------|------|------|-------------|----|
| <b>119040</b> | PZ0* | 75   | <b>3,70</b> | 12 |
| <b>119041</b> | PZ1  | 100  | <b>4,50</b> | 12 |
| <b>119042</b> | PZ2  | 150  | <b>5,59</b> | 12 |
| <b>119043</b> | PZ3  | 150  | <b>8,28</b> | 12 |

\* Screwdriver with cylindrical blade and without hexagon bolster

## Torx tapered screwdriver

Cr-V STEEL S2



| Code          | ⊕   | → mm | €           | ☞  |
|---------------|-----|------|-------------|----|
| <b>119091</b> | T10 | 80   | <b>5,66</b> | 12 |
| <b>119092</b> | T15 | 80   | <b>5,82</b> | 12 |
| <b>119093</b> | T20 | 100  | <b>5,82</b> | 12 |
| <b>119094</b> | T25 | 100  | <b>6,21</b> | 12 |
| <b>119095</b> | T27 | 100  | <b>6,31</b> | 12 |
| <b>119096</b> | T30 | 100  | <b>7,26</b> | 12 |
| <b>119097</b> | T40 | 125  | <b>8,42</b> | 12 |
| <b>119098</b> | T45 | 125  | <b>9,66</b> | 12 |

## Cabinet tip Stubby type screwdriver

DIN 5265

Cr-V  
STEEL  
S2



| Code          | Ø mm | mm  | mm | €           |    |
|---------------|------|-----|----|-------------|----|
| <b>119012</b> | 5,5  | 1,0 | 38 | <b>4,17</b> | 12 |
| <b>119014</b> | 6,5  | 1,2 | 38 | <b>5,46</b> | 12 |

## Cabinet tip Stubby type screwdriver

DIN 5262

Cr-V  
STEEL  
S2



| Code          | +   | mm | €           |    |
|---------------|-----|----|-------------|----|
| <b>119035</b> | PH1 | 38 | <b>3,93</b> | 12 |
| <b>119036</b> | PH2 | 38 | <b>4,97</b> | 12 |

## Cabinet tip Extra long screwdriver

DIN 5265

Cr-V  
STEEL  
S2



| Code          | Ø mm | mm  | mm  | €           |    |
|---------------|------|-----|-----|-------------|----|
| <b>119016</b> | 4,0  | 0,8 | 250 | <b>5,14</b> | 12 |
| <b>119018</b> | 6,0  | 1,0 | 300 | <b>7,44</b> | 12 |

## Cabinet tip Extra long screwdriver

DIN 5262

Cr-V  
STEEL  
S2



| Code          | +   | mm  | €           |    |
|---------------|-----|-----|-------------|----|
| <b>119038</b> | PH1 | 250 | <b>5,66</b> | 12 |
| <b>119039</b> | PH2 | 300 | <b>7,00</b> | 12 |

## Hexagonal socket tip screwdriver

Cr-V  
STEEL  
S2

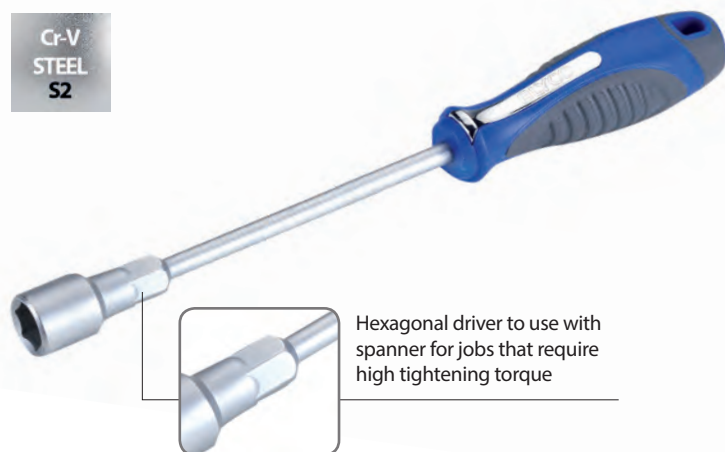

Hexagonal driver to use with spanner for jobs that require high tightening torque



| Code          | mm  | mm  | €           |    |
|---------------|-----|-----|-------------|----|
| <b>119074</b> | 5   | 150 | <b>5,86</b> | 12 |
| <b>119075</b> | 5,5 | 150 | <b>5,86</b> | 12 |
| <b>119076</b> | 6   | 150 | <b>5,86</b> | 12 |
| <b>119077</b> | 7   | 150 | <b>6,00</b> | 12 |
| <b>119078</b> | 8   | 150 | <b>6,00</b> | 12 |
| <b>119079</b> | 9   | 150 | <b>6,72</b> | 12 |
| <b>119080</b> | 10  | 150 | <b>6,72</b> | 12 |
| <b>119081</b> | 11  | 150 | <b>7,49</b> | 12 |
| <b>119082</b> | 12  | 150 | <b>7,49</b> | 12 |
| <b>119083</b> | 13  | 150 | <b>7,79</b> | 12 |
| <b>119084</b> | 14  | 150 | <b>7,79</b> | 12 |

## Magnetizer demagnetizer



To magnetize insert the shaft of the screwdriver inside the hole of the magnetizer



To demagnetize keep the tip of the screwdriver near the side slots until it is completely demagnetized



NEW

• Magnetize small tools to extract all kinds of screws and nuts easily

| Code          | Measure mm | €           |   |
|---------------|------------|-------------|---|
| <b>121530</b> | 52x50x28   | <b>1,70</b> | 6 |

Display with blister

## Screwdriver set in plastic holder



### CONTENTS

- ⊖ 3 x 75 mm\* / 4 x 80 mm (Cabinet tip)\*
- ⊖ 5,5 x 100 mm / 6,5 x 125 mm (Slotted tips)\*\*
- ⊕ PH1 x 80 mm / PH2 x 100 mm\*\*
- ⊗ PZ1 x 80 mm / PZ2 x 100 mm\*\*

\* With cylindrical shaft. No hexagonal driver.

\*\* With cylindrical shaft and hexagonal driver.

| Code          | No. of Items | €            |  |
|---------------|--------------|--------------|---|
| <b>119210</b> | 8            | <b>36,96</b> | 6   |

## Screwdriver set in plastic box



### CONTENTS

- ⊖ 3x100 mm\* / 4x100 mm (Cabinet tip)\*
- ⊖ 5'5x100 mm\*\* / 6'5x125 mm\*\* / 6'5x38 mm\*
- ⊕ PH1x100 mm\*\* / PH2x100 mm\*\* / PH2x38 mm\*
- ⊗ PZ1x100 mm\*\* / PZ2x100 mm\*\*

\* With cylindrical shaft. No hexagonal driver.

\*\* With cylindrical shaft and hexagonal driver.

| Code          | No. of Items | €            |  |
|---------------|--------------|--------------|---|
| <b>119090</b> | 10           | <b>40,47</b> | 1   |

Box dimensions: 255x185x48 mm

## Screwdriver sets



### CONTENTS 119050 - 119049

- ⊖ 3x100 mm\* / 4x100 mm (Slotted)\*
- ⊖ 5'5x125mm\*\* / 6'5x150 mm (Cabinet)\*\*
- ⊕ PH0x75mm\* / PH1x100 mm\*\*

\* With cylindrical shaft. No hexagonal driver.

\*\* With cylindrical shaft and hexagonal driver.



| Code          | No. of Items | €            |  |
|---------------|--------------|--------------|---|
| <b>119050</b> | 6            | <b>23,00</b> | 1   |

| Code          | No. of Items | €            |  |
|---------------|--------------|--------------|---|
| <b>119049</b> | 6            | <b>22,80</b> | 1   |



### CONTENTS 119055

- ⊖ 3x100 mm ((Cabinet tip)\*
- ⊖ 4x80 mm\* / 6'5x150 mm\*\* / 8x150 mm\*\* (Slotted tips)\*\*
- ⊕ PH1x100 mm\*\* / PH2x150 mm\*\*
- ⊗ PZ1x100 mm\*\* / PZ2x150 mm\*\*

\* With cylindrical shaft. No hexagonal driver.

\*\* With cylindrical shaft and hexagonal driver.

| Code          | No. of Items | €            |  |
|---------------|--------------|--------------|---|
| <b>119055</b> | 8            | <b>38,09</b> | 1   |

**Slotted tip screwdriver set**



**Slotted**

**CONTENTS**  
 3x100mm\* (B. recta), 4x80\*, 5,5x125\*\*, 6,5x150\*\*, 8x150\*\*  
 \* With cylindrical shaft. No hexagonal driver.  
 \*\* With cylindrical shaft and hexagonal driver.

| Code          | No. of Items | €            |   |
|---------------|--------------|--------------|---|
| <b>119057</b> | 5            | <b>23,60</b> | 1 |

**Phillips tip screwdriver set**



**Phillips**

**CONTENTS**  
 PH0x75\*, PH1x100\*\*, PH2x150\*\*, PH3x150\*\*, PH4x200mm\*\*  
 \* With cylindrical shaft. No hexagonal driver.  
 \*\* With cylindrical shaft and hexagonal driver.

| Code          | No. of Items | €            |   |
|---------------|--------------|--------------|---|
| <b>119058</b> | 5            | <b>27,00</b> | 1 |

**Torx Tampered screwdriver set**



**Torx tampered**

**CONTENTS**  
 T10x80, T15x80, T20x100, T25x100, T30x100, T40x125

| Code          | No. of Items | €            |   |
|---------------|--------------|--------------|---|
| <b>119099</b> | 6            | <b>39,18</b> | 6 |

**Socket tip screwdriver set**



**CONTENTS**  
 6, 8, 10, 11, 12, 13 x 150 mm

| Code          | No. of Items | €            |   |
|---------------|--------------|--------------|---|
| <b>119085</b> | 6            | <b>41,35</b> | 1 |

**Screwdriver set, nylon bag**



**Includes 22 types of tip**

|   |   |   |   |
|---|---|---|---|
|   |   |   |   |
| 5 | 3 | 2 | 4 |
|   |   |   |   |
| 6 | 1 | 1 |   |



**CONTENTS**  
 3x100\* / 4x100 mm\* (Cabinet tip)  
 5.5x125\*\* / 6.5x150 mm\*\* / 6.5x38 mm\* (Slotted tip)  
 PH1x100\*\*/ PH2x150 mm\*\* PH2x38 mm\*  
 PZ1x100\*\*, PZ2x150 mm\*\*  
 1 1/4" socket holder 1 Magnetic adaptor with handle  
 10 Bits in plastic holder  
 4 3, 4, 5, 6 mm 6 T10, T15, T20, T25, T30, T40  
 \* With cylindrical shaft. No hexagonal driver.  
 \*\* With cylindrical shaft and hexagonal driver.

| Code          | No. of Items | €            |   |
|---------------|--------------|--------------|---|
| <b>119060</b> | 22           | <b>52,86</b> | 1 |

### Ratchet screwdriver and bits set



**RATCHET MECHANISM**  
- To the right  
- To the left  
- Blocked



#### CONTENTS

- 1 Ratchet screwdriver handle
- 1 1/4" socket holder
- 2 magnetic bit drivers 60 mm, 100 mm
- 10 bits:
  - ⊖ 4, 5, 6 mm
  - ⊕ PH1, PH2
  - ⊗ T10, T15, T20
  - ⊗ PZ1, PZ2

| Code          | No. of Items | €            |   |
|---------------|--------------|--------------|---|
| <b>119155</b> | 14           | <b>15,74</b> | 1 |

Display with blister

### Ratchet screwdriver set



**RATCHET MECHANISM**  
- To the right  
- To the left  
- Blocked



#### CONTENTS

- 1 Ratchet screwdriver handle
- 1 1/4" socket holder
- 1 magnetic bit driver 100 mm
- 8 1/4" sockets: 6, 7, 8, 9, 10, 11, 12, 13 mm
- 10 bits of:
  - ⊖ 4, 5, 6 mm
  - ⊕ PH1, PH2
  - ⊗ T10, T15, T20
  - ⊗ PZ1, PZ2

| Code          | No. of Items | €            |   |
|---------------|--------------|--------------|---|
| <b>119115</b> | 21           | <b>25,97</b> | 1 |

Display with blister

### Magnetic bit driver set



#### CONTENTS

- 1 1/4" magnetic bit driver with handle 119100
- 1 1/4" socket holder
- 10 Bits:
  - ⊖ 4, 5, 6 mm
  - ⊕ PH1, PH2
  - ⊗ T10, T15, T20
  - ⊗ PZ1, PZ2

| Code          | No. of Items | €            |   |
|---------------|--------------|--------------|---|
| <b>119110</b> | 12           | <b>12,66</b> | 6 |

Display with blister

### Magnetic bit driver



| Code          |      |     | mm          | €  |  |
|---------------|------|-----|-------------|----|--|
| <b>119100</b> | 1/4" | 100 | <b>8,00</b> | 12 |  |

### Quick magnetic adaptor



| Code          |      |    | mm          | €  |  |
|---------------|------|----|-------------|----|--|
| <b>119107</b> | 1/4" | 40 | <b>8,85</b> | 12 |  |

## 1/4" Socket holder



| Code          | mm   | mm | €           |    |
|---------------|------|----|-------------|----|
| <b>119105</b> | 1/4" | 60 | <b>7,65</b> | 12 |

## 1/4" flexible magnetic bit driver



| Code          | mm   | mm  | €           |    |
|---------------|------|-----|-------------|----|
| <b>119102</b> | 1/4" | 190 | <b>9,58</b> | 12 |

## Reversible blade screwdriver



| Code          | mm |     | mm  | €           |    |
|---------------|----|-----|-----|-------------|----|
| <b>119120</b> | 6  | PH2 | 125 | <b>5,31</b> | 12 |
| <b>119125</b> | 6  | PH2 | 175 | <b>5,79</b> | 12 |
| <b>119130</b> | 6  | PH2 | 63  | <b>3,93</b> | 12 |

## Screwdriver blade set



- Bimaterial ergonomic handle
- Slots for fixing the blade to handle (double position)

**CONTENTS**

- 1 Ratchet screwdriver handle
- 10 Blades with double tip: 1- 3'0 / 4'0 mm
- 1- 5'5 / 6'5 mm 1- 3'0 / 4'0 mm 1- 5'0 / 6'0 mm
- 1- PH1 / PH2 1- PZ1 / PZ2 1- PH3 / PZ3
- 1- T10 / T15 1- T20 / T25 1- T30 / T40

| Code          | No. of Items | €            |   |
|---------------|--------------|--------------|---|
| <b>119117</b> | 11           | <b>26,00</b> | 1 |

## 20 in 1 screwdriver set

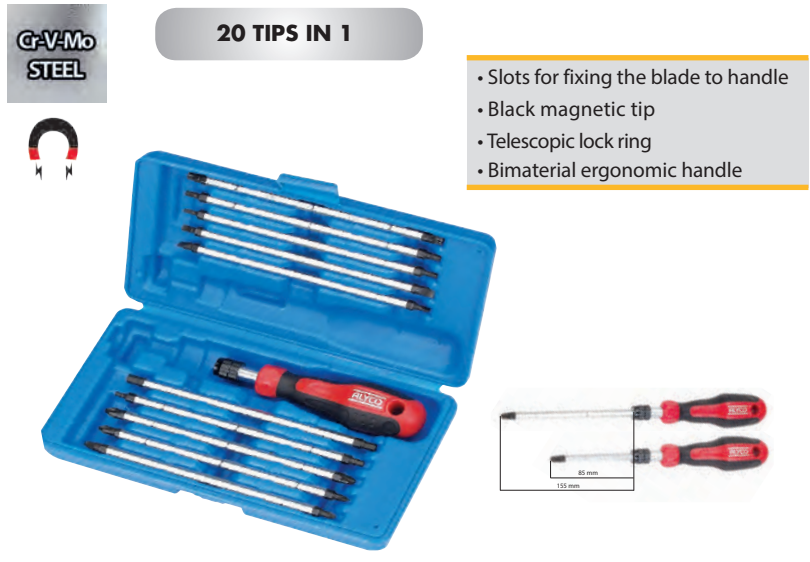

**20 TIPS IN 1**

- Slots for fixing the blade to handle
- Black magnetic tip
- Telescopic lock ring
- Bimaterial ergonomic handle

**Possibility of double position lengths for blade:**  
 - Normal with 85 mm long blade  
 - Extended with 155 mm long blade

**CONTENTS**

- 1 bimaterial handle
- 10 Blades with double tip: 1- 4.0 / 5.5 mm
- 1- 4'5 / 6'5 mm 1- 3'0 / 4'0 mm 1- 5'0 / 6'0 mm
- 1- PH1 / PH2 1- PZ1 / PZ2 1- PH3 / PZ3
- 1- T10 / T15 1- T20 / T25 1- T30 / T40

| Code          | No. of Items | €            |   |
|---------------|--------------|--------------|---|
| <b>193455</b> | 11           | <b>43,40</b> | 1 |

## Phillips tip precision screwdriver

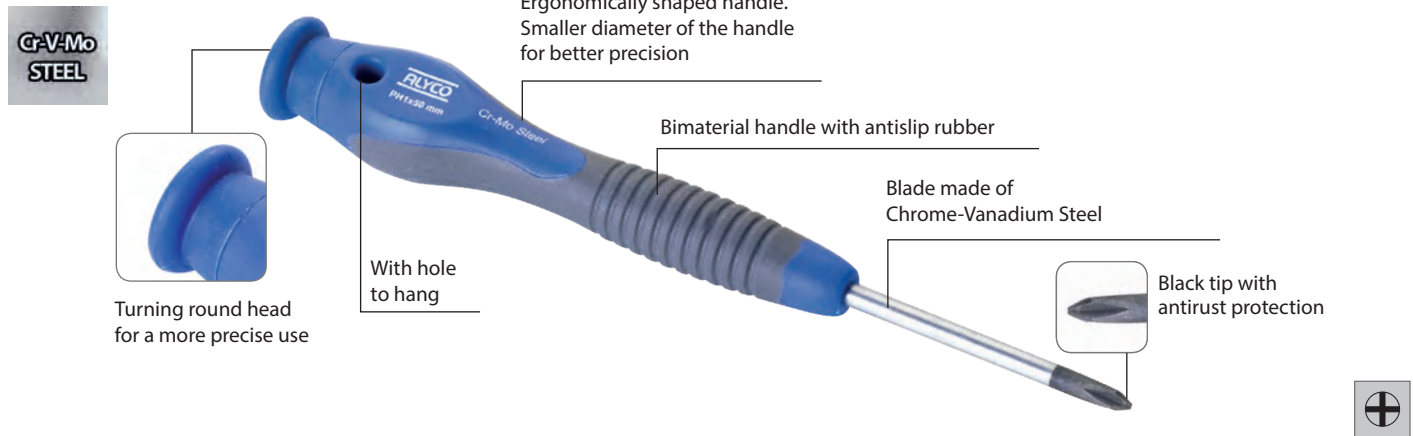

**For uses in jewellery, electronics, computers, electric household appliances...**

| Code          | ⊕    | mm | €           |    |
|---------------|------|----|-------------|----|
| <b>119529</b> | PH00 | 50 | <b>3,61</b> | 12 |
| <b>119530</b> | PH0  | 50 | <b>3,61</b> | 12 |
| <b>119531</b> | PH1  | 50 | <b>3,61</b> | 12 |

## Cabinet tip precision screwdriver



| Code          | ⊖   | mm | €           |    |
|---------------|-----|----|-------------|----|
| <b>119501</b> | 1,0 | 50 | <b>3,61</b> | 12 |
| <b>119515</b> | 1,5 | 50 | <b>3,61</b> | 12 |
| <b>119502</b> | 2,0 | 50 | <b>3,61</b> | 12 |
| <b>119525</b> | 2,5 | 50 | <b>3,61</b> | 12 |
| <b>119503</b> | 3,0 | 50 | <b>3,61</b> | 12 |

## Torx tapered tip precision screwdriver



| Code          | ⊛   | mm | €           |    |
|---------------|-----|----|-------------|----|
| <b>119535</b> | T5  | 50 | <b>3,75</b> | 12 |
| <b>119536</b> | T6  | 50 | <b>3,75</b> | 12 |
| <b>119537</b> | T7  | 50 | <b>3,75</b> | 12 |
| <b>119538</b> | T8  | 50 | <b>3,75</b> | 12 |
| <b>119539</b> | T10 | 50 | <b>3,75</b> | 12 |
| <b>119540</b> | T15 | 50 | <b>3,75</b> | 12 |

## Precision screwdriver set



### CONTENTS

- ⊖ 1'5x50, 2'0x50, 3'0x50 mm
- ⊕ PH00x50, PH0x50, PH1x50 mm

| Code          | No. of Items | €            |   |
|---------------|--------------|--------------|---|
| <b>193465</b> | 6            | <b>21,69</b> | 1 |

## 30 Precision Screwdrivers in 1 set



Colour code



Extension with 3 indents



### 30 BITS IN 1



#### CONTENTS

- 1 precision screwdriver handle
- 1 magnetic bit driver 110 mm
- Bits:
  - ⊖ 1.0, 1.5, 2.0, 2.5, 3.0, 3.5, 4.0
  - ⊕ PH000, PH00, PH0, PH1 ⊕ PZ0, PZ1
  - ⬡ 0.7, 0.9, 1.3, 1.5, 2.0, 2.5, 3.0, 4.0
  - ⊗ T4, T5, T6, T7, T8, T9, T10, T15, T20

| Code          | No. of Items | €            |   |
|---------------|--------------|--------------|---|
| <b>193467</b> | 32           | <b>26,96</b> | 1 |

## Screwdriver displayer



#### CONTENTS

##### • Go through:

- ⊖ 8x1.2x150 (12) (Cabinet tip)
- **Regular:**
  - ⊖ 5.5x1x125 (12)\*, 6.5x1.2x150 (12)\*, 8x1.2x150 (12)\* (Slotted tip)
  - ⊖ 3x0.5x100 (12), 4x0.8x100 (12) (Cabinet tip)
  - ⊕ PH1x100 (12)\*, PH2x150 (12)\*
  - ⊗ PZ1x100 (12)\*, PZ2x150 (12)\*
  - ⊗ T10x80, T15x80, T20x100
  - 1/4" magnetic bit driver (12)
  - Exchangeable screwdriver ⊕ PH2- ⊖ 6x125mm (12) (119120)

| Code          | No. of Items | €             |   |
|---------------|--------------|---------------|---|
| <b>119051</b> | 180          | <b>982,05</b> | 1 |

## Double screwdriver displayer



#### CONTENTS

##### • Go through:

- ⊖ 6'5x1'2x150 (12), 8'0x1'2x150 (12) (Plana)
- ⊕ PH1x100(12), PH2x150(12)
- ⊗ PZ1x100(12), PZ2x150(12)
- **Regular:**
  - ⊖ 4x0'8x80 (12), 5'5x1x125 (12)\*, 6'5x1'2x150 (12)\*, 8x1'2x150 (12)\* (Plana)
  - ⊖ 2'5x0'4x75 (12), 3x0'5x100 (12), 4x0'8x100 (12), 5x0'8x150 (12) (Recta)
  - ⊕ PH0x75 (12), PH1x100 (12)\*, PH2x150 (12)\*, PH3x150 (12)\*
  - ⊗ PZ0x75 (12), PZ1x100 (12)\*, PZ2x150 (12)\*
  - ⊗ T10x80 (12), T15x80 (12), T20x100 (12)
- **Stubby type:**
  - ⊖ 6'5x1'2x38 (12) (Plana) ⊕ PH2x38 (12)
- **Extra long:**
  - ⊖ 6x1x300 (12) (Plana) ⊕ PH2x300 (12)
- Exchangeable screwdriver ⊕ PH2 ⊖ 6x175 (12) (119125)
- Exchangeable screwdriver ⊕ PH2 ⊖ 6x63 (12) (119130)

\* With hexagonal driver and hexagonal shaft

| Code          | No. of Items | €               |   |
|---------------|--------------|-----------------|---|
| <b>119052</b> | 360          | <b>1.946,26</b> | 1 |

## Slotted tip insulated screwdriver

DIN 5265

Cr-V-Mo STEEL

VDE Certificate

### EN 60900 STANDARD

Insulated tools used for jobs on voltages of up to 1000 V in AC current or up to 1500 V in DC.

NEW DESIGN

Ergonomically shaped bimaterial handle

### RECESSED BLADE

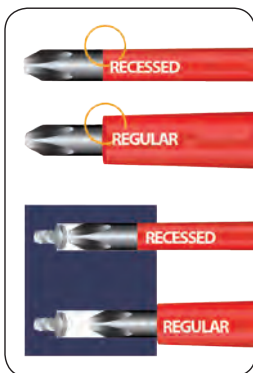

Better access in restricted spaces

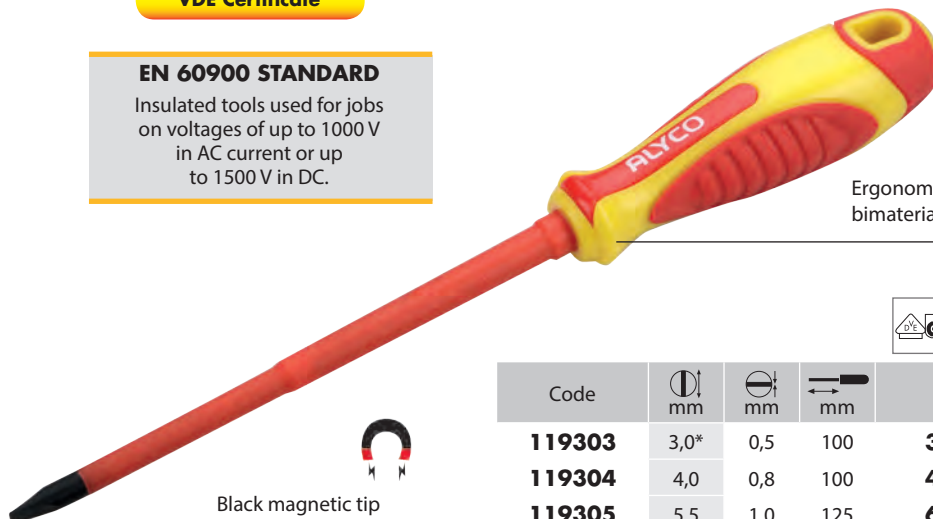

| Code   | mm   | mm  | mm  | €     |    |
|--------|------|-----|-----|-------|----|
| 119303 | 3,0* | 0,5 | 100 | 3,72  | 12 |
| 119304 | 4,0  | 0,8 | 100 | 4,50  | 12 |
| 119305 | 5,5  | 1,0 | 125 | 6,09  | 12 |
| 119306 | 6,5  | 1,2 | 150 | 7,68  | 12 |
| 119308 | 8,0  | 1,2 | 175 | 10,09 | 12 |

\* Measurement without recessed blade

## Phillips tip insulated screwdriver

DIN 5262

### RECESSED BLADE

Cr-V-Mo STEEL

VDE Certificate



| Code   |      | mm  | €    |    |
|--------|------|-----|------|----|
| 119310 | PH0* | 75  | 4,05 | 12 |
| 119311 | PH1  | 100 | 5,03 | 12 |
| 119312 | PH2  | 100 | 6,09 | 12 |

\* Measurement without recessed blade

## Pozidrive tip insulated screwdriver

DIN 5262

### RECESSED BLADE

Cr-V-Mo STEEL

VDE Certificate



| Code   |     | mm  | €    |    |
|--------|-----|-----|------|----|
| 119321 | PZ1 | 100 | 5,60 | 12 |
| 119322 | PZ2 | 100 | 6,77 | 12 |

## Insulated socket tip screwdriver

Cr-V STEEL S2

NEW

VDE Certificate



| Code   | mm  | mm  | €    |    |
|--------|-----|-----|------|----|
| 119345 | 5   | 125 | 6,97 | 10 |
| 119344 | 5,5 | 125 | 6,97 | 10 |
| 119346 | 6   | 125 | 6,97 | 10 |
| 119347 | 7   | 125 | 7,12 | 10 |
| 119348 | 8   | 125 | 7,12 | 10 |
| 119349 | 9   | 125 | 7,54 | 10 |
| 119350 | 10  | 125 | 7,54 | 10 |
| 119351 | 11  | 125 | 8,36 | 10 |
| 119352 | 12  | 125 | 8,36 | 10 |
| 119353 | 13  | 125 | 8,60 | 10 |

## Insulated screwdriver set in plastic holder



RECESSED BLADE

VDE Certificate



### CONTENTS

- ⊖ 3x100\*, 4x100, 5'5x125, 6'5x150 mm
- ⊕ PH0x75, PH1x100, PH2x100 mm
- ⊖ Tester 3x140 mm
- \* Not recessed blade

| Code   | No. of Items | €     |   |
|--------|--------------|-------|---|
| 119340 | 8            | 36,96 | 1 |

## Insulated screwdriver set in plastic box



Box dimensions: 255x185x48 mm



RECESSED BLADE

VDE Certificate



### CONTENTS

- ⊖ 3x100\*, 4x100, 5'5x100 mm
- ⊕ PH1x100, PH2x100 mm
- ⊕ PZ1x100, PZ2x100 mm
- ⊖ Tester 3x140 mm
- \* Not recessed blade

| Code   | No. of Items | €     |   |
|--------|--------------|-------|---|
| 119335 | 8            | 39,74 | 1 |

## Insulated screwdriver set in carton box

RECESSED BLADE



VDE Certificate



### CONTENTS

- ⊖ 3x100\*, 4x100, 5'5x125, 6'5x150 mm
- ⊕ PH1x100, PH2x100 mm
- \* Not recessed blade

| Code   | No. of Items | €     |   |
|--------|--------------|-------|---|
| 119330 | 6            | 33,72 | 1 |

## Insulated screwdriver set in plastic blister



RECESSED BLADE



VDE Certificate



### CONTENTS

- ⊖ 3x100\*, 4x100, 5'5x125, 6'5x150 mm
- ⊕ PH1x100, PH2x100 mm
- \* Not recessed blade

| Code   | No. of Items | €     |   |
|--------|--------------|-------|---|
| 119331 | 6            | 32,30 | 1 |

## Phillips tip precision screwdriver

Gr-V-Mo  
STEEL



### EN 60900 STANDARD

Insulated tools used for jobs on voltages of up to 1000 V in AC current or up to 1500 V in DC.

NEW

### VDE Certificate



| Code          | Tip  | mm | €           | Items |
|---------------|------|----|-------------|-------|
| <b>119365</b> | PH00 | 50 | <b>4,16</b> | 12    |
| <b>119366</b> | PH0  | 50 | <b>4,16</b> | 12    |
| <b>119367</b> | PH1  | 50 | <b>4,16</b> | 12    |

## Cabinet tip precision screwdriver

Gr-V-Mo  
STEEL

NEW



### VDE Certificate



| Code          | Tip | mm | €           | Items |
|---------------|-----|----|-------------|-------|
| <b>119361</b> | 1,5 | 50 | <b>4,16</b> | 12    |
| <b>119362</b> | 2,0 | 50 | <b>4,16</b> | 12    |
| <b>119363</b> | 2,5 | 50 | <b>4,16</b> | 12    |
| <b>119364</b> | 3,0 | 50 | <b>4,16</b> | 12    |

## Torx tip precision screwdriver

Gr-V-Mo  
STEEL

NEW



### VDE Certificate



| Code          | Tip | mm | €           | Items |
|---------------|-----|----|-------------|-------|
| <b>119368</b> | T5  | 50 | <b>4,16</b> | 12    |
| <b>119369</b> | T6  | 50 | <b>4,16</b> | 12    |
| <b>119370</b> | T7  | 50 | <b>4,16</b> | 12    |
| <b>119371</b> | T8  | 50 | <b>4,16</b> | 12    |
| <b>119372</b> | T10 | 50 | <b>4,16</b> | 12    |
| <b>119373</b> | T15 | 50 | <b>4,16</b> | 12    |

## Precision screwdriver set



NEW

### VDE Certificate

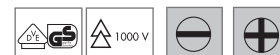

### CONTENTS

⊖ 1'5x50, 2'0x50, 3'0x50 mm  
⊕ PH00x50, PH0x50, PH1x50 mm

| Code          | No. of Items | €            | Items |
|---------------|--------------|--------------|-------|
| <b>119375</b> | 6            | <b>24,10</b> | 1     |

## Insulated interchangeable screwdrivers set



RECESSED BLADE

NEW

VDE Certificate



### CONTENTS

- ⊖ 3x75\*, 4x100, 5'5x125, 6,5x150 mm
  - ⊕ PH0x75\*, PH1x100, PH2x100 mm
  - ⊕ PZ1x100, PZ2x100 mm
  - ⊖ Tester 3x140 mm
- \* Not recessed blade

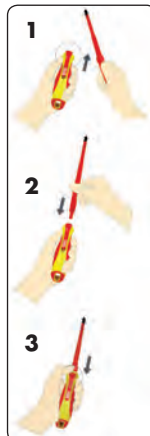

| Code   | No. of Items | €     |   |
|--------|--------------|-------|---|
| 119332 | 11           | 37,20 | 3 |

## Multimeter



INCLUDES:



2 x AA

### FUNCTIONS:

- Tension
- Intensity
- Resistance
- Diode

NEW

- Big screen LCD
- Roulette wheel for a easy selection
- Ergonomic design

| Code   | €     |   |
|--------|-------|---|
| 119339 | 25,40 | 1 |

Display in case with hanger

## Tester 8 in 1



L: 190 mm

NEW

## Tester 3 in 1



L: 190 mm

NEW

VOLTAGE TESTABLE 6, 12, 24, 50, 110, 220 and 380 V 6 V

| Code   | €     |   |
|--------|-------|---|
| 119338 | 22,40 | 1 |

Display with blister

## Tester



TESTABLE VOLTAGE  
100-250 V.



| Code   | mm | mm  | €    |    |
|--------|----|-----|------|----|
| 193369 | 3  | 140 | 3,14 | 24 |



## 07 Sockets



**1/4"**  
sq. dr. socket **129**



**3/8"**  
sq. dr. socket **134**



**1/2"**  
sq. dr. socket **136**



**Automotive**  
socket **142**



**Insulated**  
socket **144**



**3/4"**  
sq. dr. socket **146**



**1"**  
sq. dr. socket **148**



**Impact**  
socket **149**

## 1/4" sq. dr. socket set

Cr-V  
STEEL

Extending  
ratchet  
handle



Box dimensions: 365x240x85 mm

### CONTENTS

|    |                                      |   |                               |   |                               |
|----|--------------------------------------|---|-------------------------------|---|-------------------------------|
| 1  | Offset ratchet handle 192139         | 1 | Flexible extension bar 150 mm | 1 | Socket holder 1/4"            |
| 13 | Sockets 4 to 14 mm                   | 2 | Extension bars 50, 150 mm     | 1 | Spinner handle 150 mm         |
| 6  | Deep sockets 6, 7, 8, 10, 12, 13 mm  | 1 | Universal joint               | 4 | Hex keys 1.25, 1.5, 2, 2.5 mm |
| 5  | Torx sockets E-4, E-5, E-6, E-7, E-8 | 1 | Coupler 1/4" M x 3/8" F       | 1 | Magnetic bit holder 1/4"      |
| 21 | Insert bit sockets                   |   |                               |   |                               |
| 6  | 3, 4, 5, 6, 7, 8 mm                  | 3 | 4, 5.5, 7 mm                  | 3 | PH1, PH2, PH3                 |
|    |                                      | 3 |                               | 3 | PZ1, PZ2, PZ3                 |
|    |                                      | 6 |                               | 6 | T10, T15, T20, T25, T30, T40  |



| Code          | No. of Items | €            |   |
|---------------|--------------|--------------|---|
| <b>192187</b> | 58           | <b>63,20</b> | 1 |

## 1/4" sq. dr. Socket set - inches

Cr-V  
STEEL

Extending  
ratchet  
handle



Box dimensions: 365x240x85 mm



### CONTENTS

|    |   |   |                               |   |                               |
|----|---|---|-------------------------------|---|-------------------------------|
| 1  | Offset ratchet handle 192139  | 1 | Flexible extension bar 150 mm | 1 | Magnetic bit holder 1/4"      |
| 11 | Sockets 5/32", 3/16", 7/32", 1/4", 9/32", 5/16", 11/32", 3/8", 7/16", 1/2", 9/16" | 2 | Extension bars 50, 150 mm     | 1 | Socket holder 1/4"            |
| 6  | Deep sockets 1/4", 9/32", 5/16", 3/8", 7/16", 1/2"                                | 1 | Universal joint               | 1 | Spinner handle 150 mm         |
| 5  | Torx sockets E-4, E-5, E-6, E-7, E-8  | 1 | Coupler 3/8" F x 1/4" M       | 4 | Hex keys 1.25, 1.5, 2, 2.5 mm |
| 21 | Insert bit sockets  |   |                               |   |                               |
| 6  | 3, 4, 5, 6, 7, 8 mm   | 3 | 4, 5.5, 7 mm                  | 3 | PH1, PH2, PH3                 |
|    |   | 3 |                               | 3 | PZ1, PZ2, PZ3                 |
|    |   | 6 |                               | 6 | T10, T15, T20, T25, T30, T40  |



| Code          | No. of Items | €            |   |
|---------------|--------------|--------------|---|
| <b>190295</b> | 56           | <b>70,36</b> | 1 |

## 1/4" sq. dr. socket set

Cr-V  
STEEL

Extending  
ratchet  
handle



Handy case



Box dimensions: 160x110x40 mm



### CONTENTS

|    |                              |   |                     |   |                          |
|----|------------------------------|---|---------------------|---|--------------------------|
| 1  | Offset ratchet handle 192139 | 1 | Bit holder 1/4"     | 1 | Magnetic bit holder 1/4" |
| 10 | Sockets 4 to 13 mm           | 1 | Extension bar 75 mm |   |                          |
| 15 | Insert bit sockets           |   |                     |   |                          |
| 3  | 5, 6, 8 mm                   | 3 | 4, 5.5, 6.5 mm      | 3 | PH1, PH2, PH3            |
|    |                              | 3 |                     | 3 | PZ1, PZ2, PZ3            |
|    |                              | 6 |                     | 6 | T15, T20, T25            |



| Code          | No. of Items | €            |   |
|---------------|--------------|--------------|---|
| <b>192195</b> | 29           | <b>45,66</b> | 6 |

## 1/4" sq. dr. go-through socket set

Cr-V  
STEEL



Box dimensions: 335x175x50 mm

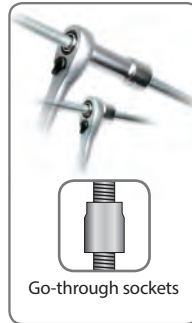

### CONTENTS

|                     |    |   |                 |                                |                               |
|---------------------|----|---|-----------------|--------------------------------|-------------------------------|
| Go-through contents | 8  | Go-through sockets 10 to 19 mm              | 1               | Go-through extension bar 75 mm |                               |
|                     | 1  | 1/4" ratchet adapter for go-through sockets |                 |                                |                               |
| 1/4" sockets        | 13 | Sockets 4 to 14 mm                          | 1               | Extension bar 50 mm            |                               |
|                     | 1  | Bit holder 1/4"                             | 1               | Go-through ratchet handle 1/4" |                               |
| 5/16" bits          | 20 | Bits  |                 | 1                              | Handle with ratchet mechanism |
|                     |    | 4 3, 4, 5, 6, 6, mm                         | 3 4, 5, 5, 7 mm | 3 PH1, PH2, PH3                | 3 PZ1, PZ2, PZ3               |



| Code          | No. of Items | €            |   |
|---------------|--------------|--------------|---|
| <b>192182</b> | 47           | <b>70,87</b> | 5 |

## 1/4" sq. dr. extendable ratchet handle

Cr-V  
STEEL

Extending ratchet handle



- With reversor lever and quick release mechanism
- Length can be adjusted to 6 different lengths between 150 and 200 mm



| Code          | L mm    | €            |   |
|---------------|---------|--------------|---|
| <b>192139</b> | 150/200 | <b>23,67</b> | 5 |

Display with hanger

## 1/4" sq. dr. Stubby ratchet handle

Cr-V  
STEEL



- With reversor and quick release mechanism



| Code          | L mm | €            |   |
|---------------|------|--------------|---|
| <b>192136</b> | 112  | <b>14,91</b> | 5 |

Display with hanger

## 1/4" sq. dr. metal ratchet handle

Cr-V  
STEEL



- With reversor and quick release mechanism



| Code          | L mm | €            |   |
|---------------|------|--------------|---|
| <b>192138</b> | 153  | <b>19,74</b> | 5 |

Display with hanger

## 1/4" sq. dr. Dual ratchet

Cr-V  
STEEL



- 1 For using with 1/4" dr. sockets
- 2 For using with 1/4" bits.

- With reverse lever



| Code          | L mm | €            |   |
|---------------|------|--------------|---|
| <b>192133</b> | 112  | <b>15,84</b> | 5 |

Display with hanger

## 1/4" sq. dr. socket

DIN 3124

• Satin finish

Cr-V STEEL

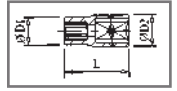

| Code   | mm  | L mm | D1 mm | D2 mm | €    |    |
|--------|-----|------|-------|-------|------|----|
| 192101 | 4   | 25   | 6,8   | 11,9  | 2,49 | 10 |
| 192102 | 4,5 | 25   | 7,1   | 11,9  | 2,49 | 10 |
| 192103 | 5   | 25   | 8     | 11,9  | 2,49 | 10 |
| 192104 | 5,5 | 25   | 8,3   | 11,9  | 2,49 | 10 |
| 192105 | 6   | 25   | 9,3   | 11,9  | 2,49 | 10 |
| 192106 | 7   | 25   | 10,5  | 11,9  | 2,49 | 10 |
| 192107 | 8   | 25   | 11,9  | 11,9  | 2,49 | 10 |
| 192108 | 9   | 25   | 12,9  | 12,9  | 2,49 | 10 |
| 192109 | 10  | 25   | 13,9  | 13,9  | 2,69 | 10 |
| 192110 | 11  | 25   | 15,8  | 15,8  | 2,69 | 10 |
| 192111 | 12  | 25   | 16,8  | 16,8  | 2,83 | 10 |
| 192112 | 13  | 25   | 17,8  | 17,8  | 3,70 | 10 |
| 192113 | 14  | 25   | 17,5  | 17,8  | 3,90 | 10 |



| Code   | mm     | L mm | D1 mm | D2 mm | €    |   |
|--------|--------|------|-------|-------|------|---|
| 190250 | 5/32"  | 21   | 6,9   | 11,9  | 2,49 | 1 |
| 190252 | 3/16"  | 21   | 7,5   | 11,9  | 2,49 | 1 |
| 190254 | 7/32"  | 21   | 8,1   | 11,9  | 2,49 | 1 |
| 190256 | 1/4"   | 21   | 9,9   | 11,9  | 2,49 | 1 |
| 190258 | 9/32"  | 21   | 11,9  | 11,9  | 2,49 | 1 |
| 190260 | 5/16"  | 21   | 11,9  | 11,9  | 2,49 | 1 |
| 190262 | 11/32" | 21   | 12,9  | 12,9  | 2,49 | 1 |
| 190264 | 3/8"   | 21   | 13,9  | 13,9  | 2,69 | 1 |
| 190266 | 7/16"  | 21   | 16,2  | 16,2  | 2,69 | 1 |
| 190268 | 1/2"   | 21   | 18,9  | 18,9  | 2,74 | 1 |
| 190270 | 9/16"  | 21   | 19,9  | 19,9  | 3,70 | 1 |

## 1/4" sq. dr. socket in plastic rack



### CONTENTS

Sockets of 4, 4'5, 5, 5'5, 6, 7, 8, 9, 10, 11, 12, 13, 14 mm

| Code   | No. of Items | €     |   |
|--------|--------------|-------|---|
| 192119 | 13           | 28,00 | 1 |

## 1/4" sq. dr. deep socket

DIN 3124

LONG SERIES

Cr-V STEEL

• Satin finish



| Code   | mm | L mm | D1 mm | D2 mm | €    |    |
|--------|----|------|-------|-------|------|----|
| 192120 | 6  | 50   | 9,3   | 11,9  | 4,91 | 10 |
| 192121 | 7  | 50   | 10,5  | 11,9  | 4,91 | 10 |
| 192122 | 8  | 50   | 11,9  | 11,9  | 4,91 | 10 |
| 192124 | 10 | 50   | 14,5  | 14,5  | 4,91 | 10 |
| 192126 | 12 | 50   | 16,8  | 16,8  | 5,21 | 10 |
| 192127 | 13 | 50   | 17,8  | 17,8  | 5,60 | 10 |

| Code   | mm    | L mm | D1 mm | D2 mm | €    |   |
|--------|-------|------|-------|-------|------|---|
| 190280 | 1/4"  | 50   | 10,3  | 11,9  | 4,91 | 1 |
| 190282 | 9/32" | 50   | 10,6  | 11,9  | 4,91 | 1 |
| 190284 | 5/16" | 50   | 11,9  | 11,9  | 4,91 | 1 |
| 190286 | 3/8"  | 50   | 14,7  | 14,7  | 4,91 | 1 |
| 190288 | 7/16" | 50   | 16,5  | 16,5  | 5,21 | 1 |
| 190290 | 1/2"  | 50   | 17,9  | 17,9  | 5,60 | 1 |

## 1/4" sq. dr. torx socket (E-type)

Cr-V STEEL

• Satin finish



| Code   |    | L mm | €    |    |
|--------|----|------|------|----|
| 192114 | E4 | 27   | 3,16 | 10 |
| 192115 | E5 | 27   | 3,16 | 10 |
| 192116 | E6 | 27   | 3,16 | 10 |
| 192117 | E7 | 27   | 3,16 | 10 |
| 192118 | E8 | 27   | 3,16 | 10 |

## 1/4" sq. dr. insert bit socket



| Code   | Ø mm | mm  | €    |    |
|--------|------|-----|------|----|
| 192014 | 4    | 0,8 | 4,06 | 10 |
| 192015 | 5,5  | 1   | 4,06 | 10 |
| 192016 | 6,5  | 1,2 | 4,06 | 10 |
| 192018 | 8    | 1,2 | 4,06 | 10 |

| Code   |     | €    |    |
|--------|-----|------|----|
| 192021 | PH1 | 4,06 | 10 |
| 192022 | PH2 | 4,06 | 10 |
| 192023 | PH3 | 4,06 | 10 |

| Code   |     | €    |    |
|--------|-----|------|----|
| 192031 | PZ1 | 4,06 | 10 |
| 192032 | PZ2 | 4,06 | 10 |
| 192033 | PZ3 | 4,06 | 10 |

| Code   |     | €    |    |
|--------|-----|------|----|
| 192040 | T6  | 4,46 | 10 |
| 192041 | T7  | 4,46 | 10 |
| 192042 | T8  | 4,46 | 10 |
| 192043 | T9  | 4,46 | 10 |
| 192044 | T10 | 4,46 | 10 |
| 192045 | T15 | 4,46 | 10 |
| 192046 | T20 | 4,46 | 10 |
| 192047 | T25 | 4,46 | 10 |
| 192048 | T30 | 4,46 | 10 |
| 192049 | T40 | 4,46 | 10 |

Cr-V  
STEEL

LENGTH  
37 MM

| Code   | mm | €    |    |
|--------|----|------|----|
| 192003 | 3  | 4,06 | 10 |
| 192004 | 4  | 4,06 | 10 |
| 192005 | 5  | 4,06 | 10 |
| 192006 | 6  | 4,06 | 10 |
| 192008 | 8  | 4,06 | 10 |

| Code   |    | €    |    |
|--------|----|------|----|
| 192064 | M4 | 4,06 | 10 |
| 192065 | M5 | 4,06 | 10 |
| 192066 | M6 | 4,06 | 10 |
| 192068 | M8 | 4,06 | 10 |

| Code   |     | €    |    |
|--------|-----|------|----|
| 192051 | T6  | 5,86 | 10 |
| 192052 | T7  | 5,86 | 10 |
| 192053 | T8  | 5,86 | 10 |
| 192054 | T9  | 5,86 | 10 |
| 192055 | T10 | 5,86 | 10 |
| 192056 | T15 | 5,86 | 10 |
| 192057 | T20 | 5,86 | 10 |
| 192058 | T25 | 5,86 | 10 |
| 192059 | T30 | 5,86 | 10 |
| 192060 | T40 | 5,86 | 10 |

## 1/4" sq. dr. insert bit socket set on metal rack



### CONTENTS

- 3, 4, 5, 6, 8 mm
- ⊕ PH1, PH2, PH3
- 0'8x4, 1x5'5, 1'2x6'5, 1'2x8 mm

| Code   | No. of Items | €     |   |
|--------|--------------|-------|---|
| 192050 | 12           | 41,00 | 1 |

## 1/4" sq. dr. socket displayer



### CONTENTS

- 120 1/4" sockets (10 units each size)  
192101, 192102, 192103, 192104, 192105, 192106, 192107, 192108, 192109, 192110, 192111, 192112
- 130 1/4" Dr. insert bit sockets (10 units each size)  
192021, 192022, 192003, 192004, 192005, 192006, 192008, 192014, 192015, 192016, 192122, 192124, 192127

| Code   | No. of Items | €      |   |
|--------|--------------|--------|---|
| 192100 | 250          | 878,27 | 1 |

## Accessories for 1/4" sockets

Cr-V  
STEEL

• Satin finish



### 1/4" sq. dr. spinner handle

DIN  
3122



| Code          | L mm | €           |   |
|---------------|------|-------------|---|
| <b>192145</b> | 150  | <b>8,04</b> | 6 |

### 1/4" sq. dr. flexible spinner handle

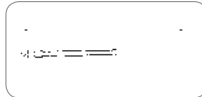

| Code          | L mm | €            |   |
|---------------|------|--------------|---|
| <b>192155</b> | 200  | <b>14,98</b> | 6 |

Only for clockwise tightening. With external hexagon

### 1/4" sq. dr. extension bar

DIN  
3123



With external hexagon

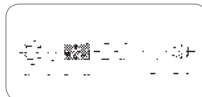

| Code          | L mm | €           |   |
|---------------|------|-------------|---|
| <b>192160</b> | 50   | <b>5,07</b> | 6 |
| <b>192161</b> | 75   | <b>7,25</b> | 6 |
| <b>192162</b> | 100  | <b>7,70</b> | 6 |
| <b>192163</b> | 150  | <b>9,01</b> | 6 |

### 1/4" sq. dr. flexible extension bar

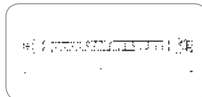

| Code          | L mm | €            |   |
|---------------|------|--------------|---|
| <b>192150</b> | 150  | <b>11,96</b> | 6 |

Only for clockwise tightening. With external hexagon

### 1/4" sq. dr. sliding tee handle

DIN  
3123



| Code          | L mm | €           |   |
|---------------|------|-------------|---|
| <b>192164</b> | 100  | <b>8,08</b> | 6 |

### 1/4" sq. dr. universal joint

DIN  
3123

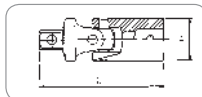

| Code          | L mm | D mm | €            |    |
|---------------|------|------|--------------|----|
| <b>192165</b> | 40   | 14   | <b>14,63</b> | 10 |

### 1/4" sq. dr. bit holder for 1/4" bits

DIN  
3121

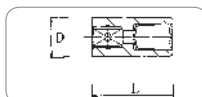

| Code          | L mm | D mm | €           |    |
|---------------|------|------|-------------|----|
| <b>192170</b> | 25   | 12   | <b>4,48</b> | 10 |

Spring locking of bits

### 1/4" F x 3/8" M coupler

DIN  
3123



| Code          | Female | Male | €           |    |
|---------------|--------|------|-------------|----|
| <b>192605</b> | 1/4"   | 3/8" | <b>4,96</b> | 10 |

## 3/8" sq. dr. socket set

Cr-V  
STEEL

Extending  
ratchet  
handle



Box dimensions: 365x240x85 mm

### CONTENTS

|    |                                       |   |                           |   |                          |
|----|---------------------------------------|---|---------------------------|---|--------------------------|
| 1  | Offset ratchet handle 192244          | 2 | Extension bars 75, 125 mm | 1 | Socket holder 3/8"       |
| 14 | Sockets 8 to 22 mm                    | 1 | Universal joint           | 1 | Bit holder for 1/4" bits |
| 6  | Deep sockets 8, 10, 12, 13, 17, 19 mm | 1 | Coupler 3/8" M x 1/2" F   |   |                          |
| 2  | Spark plug sockets 16, 21 mm          | 1 | Magnetic bit holder 1/4"  |   |                          |
| 24 | Bits 1/4"                             |   |                           |   |                          |

WITH ADAPTERS FOR  
POWER TOOL  
AND PNEUMATIC



| Code   | No. of Items | €     |   |
|--------|--------------|-------|---|
| 192287 | 54           | 92,50 | 1 |

## 3/8" sq. dr. extendable ratchet handle

Cr-V  
STEEL

Extending  
ratchet  
handle

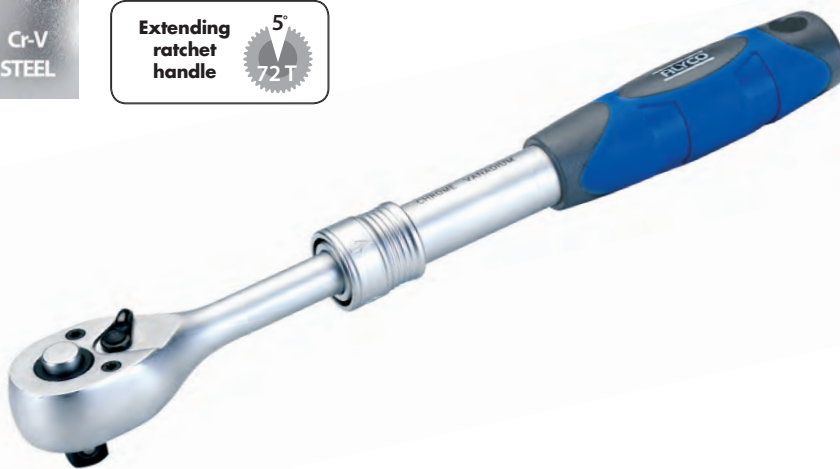

- Reversible and quick release ratchet handle
- Bimaterial ergonomic handle
- Length can be adjusted to 6 different lengths between 215 and 315 mm



| Code   | L mm    | €     |   |
|--------|---------|-------|---|
| 192244 | 215/315 | 33,58 | 5 |

Display with hanger

## 3/8" sq. dr. metal ratchet handle

Cr-V  
STEEL



- Quick release and reversor



| Code   | L mm | €     |   |
|--------|------|-------|---|
| 192243 | 202  | 28,03 | 5 |

Display with hanger

## 3/8" sq. dr. stubby ratchet handle

Cr-V  
STEEL



| Code   | L mm | €     |   |
|--------|------|-------|---|
| 192246 | 140  | 18,68 | 5 |

Display with hanger

## 3/8" sq. dr. socket

DIN 3124

REGULAR TYPE



Cr-V STEEL

Satin finish

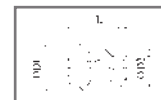

| Code   | mm | L mm | D1 mm | D2 mm | €    |    |
|--------|----|------|-------|-------|------|----|
| 192208 | 8  | 28   | 11,8  | 16,8  | 3,28 | 10 |
| 192209 | 9  | 28   | 13,2  | 16,8  | 3,37 | 10 |
| 192210 | 10 | 28   | 14,5  | 16,8  | 3,52 | 10 |
| 192211 | 11 | 28   | 15,7  | 16,8  | 3,60 | 10 |
| 192212 | 12 | 28   | 16,8  | 16    | 3,63 | 10 |
| 192213 | 13 | 28   | 17,8  | 16,5  | 3,72 | 10 |
| 192214 | 14 | 28   | 19,6  | 17    | 3,97 | 10 |
| 192215 | 15 | 28   | 20,8  | 18    | 4,11 | 10 |
| 192216 | 16 | 30   | 21,8  | 19    | 4,32 | 10 |
| 192217 | 17 | 30   | 23,4  | 20    | 4,55 | 10 |
| 192218 | 18 | 30   | 24,6  | 21    | 4,66 | 10 |
| 192219 | 19 | 30   | 25,8  | 23    | 4,83 | 10 |
| 192221 | 21 | 32   | 27,8  | 25    | 5,03 | 10 |
| 192222 | 22 | 32   | 29,6  | 26    | 5,17 | 10 |



DEEP TYPE



| Code   | mm | L mm | D1 mm | D2 mm | €    |    |
|--------|----|------|-------|-------|------|----|
| 192228 | 8  | 63   | 11,8  | 16,9  | 5,58 | 10 |
| 192230 | 10 | 63   | 14,5  | 16,9  | 5,60 | 10 |
| 192232 | 12 | 63   | 16,9  | 16    | 5,81 | 10 |
| 192233 | 13 | 63   | 17,9  | 16,5  | 5,93 | 10 |
| 192237 | 17 | 63   | 23,4  | 20    | 7,10 | 10 |
| 192239 | 19 | 63   | 25,8  | 23    | 7,49 | 10 |

## 3/8" sockets in plastic rack



CONTENTS

8, 9, 10, 11, 12, 13, 14, 15, 16, 17, 18 mm



| Code   | No. of Items | €     |   |
|--------|--------------|-------|---|
| 192225 | 11           | 33,00 | 1 |

## 3/8" extension bar

DIN 3123



With external hexagon

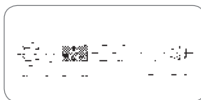

| Code   | L mm | €     |   |
|--------|------|-------|---|
| 192250 | 75*  | 11,71 | 6 |
| 192255 | 75   | 8,35  | 6 |
| 192260 | 150  | 10,34 | 6 |

\* Wobble extension bar (rounded drive of 3/8")

## 3/8" universal joint

DIN 3123

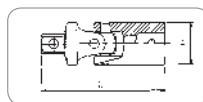

| Code   | L mm | D mm | €     |   |
|--------|------|------|-------|---|
| 192265 | 54   | 16   | 19,39 | 6 |

## 3/8" coupler

DIN 3123



| Code   | Female | Male | €    |    |
|--------|--------|------|------|----|
| 192610 | 3/8"   | 1/4" | 6,92 | 10 |
| 192615 | 3/8"   | 1/2" | 8,56 | 10 |

• With hole for extension bars

## 3/8" spark plug socket



| Code   | mm | €     |   |
|--------|----|-------|---|
| 192275 | 16 | 8,05  | 6 |
| 192276 | 21 | 11,19 | 6 |

## 3/8" bit holder

DIN 3123



For ratchet 3/8"  
For tips 1/4"



For ratchet 3/8"  
For tips 3/8"



| Code   | for bits | €    |   |
|--------|----------|------|---|
| 192270 | 1/4"     | 6,25 | 6 |
| 186185 | 3/8"     | 7,15 | 6 |

## 1/2" - 1/4" - 3/8" sq. dr. socket set

Cr-V  
STEEL

Extending  
ratchet  
handle 1/2"  
and 3/8"



**BOX WITH  
CLOSURES AND  
METAL HINGES**



Box dimensions: 440x370x110 mm

### CONTENTS 1/2"

|   |                                      |                                 |
|---|--------------------------------------|---------------------------------|
| 17 Sockets<br>10 to 32 mm               | 1 Universal<br>joint                 | 1 Bit holder<br>5/16"           |
| 5 Deep sockets<br>14, 15, 17, 19, 22 mm | 2 Spark plug<br>sockets<br>16, 21 mm | 2 Extension bars<br>125, 250 mm |
| 3 Torx sockets<br>E20, E22, E24         | 1 Offset ratchet<br>handle 192344    |                                 |

### CONTENTS 3/8"

|   |                                  |   |
|---|----------------------------------|---|
| 10 Sockets<br>10 to 19 mm                   | 1 Universal<br>joint             | 1 Bit holder<br>1/4"  |
| 6 Deep sockets<br>10, 11, 12, 13, 14, 15 mm | 1 Spark plug<br>sockets<br>16 mm | 2 Extension bars<br>75, 150 mm  |
| 5 Torx sockets<br>E10, E12, E14, E16, E18   | 1 Offset ratchet<br>handle       | 10 Insert bit sockets<br>5 6, 7,<br>8, 9,<br>10 mm  5 T45, T47,<br>T50, T55,<br>T60 |

### CONTENTS 1/4"

|   |   |                            |
|---|---|----------------------------|
| 13 Sockets<br>4 to 14 mm  | 1 Universal<br>joint  | 1 Ratchet handle<br>192138 |
| 7 Deep sockets<br>4, 5, 6, 7, 8, 9, 10 mm   | 2 Extension bars<br>50, 100 mm  | 1 Spinner handle<br>150 mm |
| 5 Torx sockets<br>E4, E5, E6, E7, E8  | 30 Insert bit sockets<br>5 3, 4, 5,<br>6, 7 mm  8 3, 4, 4.5, 5,<br>5.5, 6, 6.5,<br>7 mm  4 PH0, PH1<br>PH2, PH3  4 PZ0, PZ1<br>PZ2, PZ3  9 T8, T9, T10, T15, T20,<br>T25, T27, T30, T40 |                            |
| 21 Bits 5/16"<br>7 4, 5, 6, 7, 8,<br>10, 12 mm  2 PH2,<br>PH3  7 T20, T25, T30<br>T40, T45, T50, T55  5 M5, M6, M8,<br>M10, M12 |   |                            |
| 5 Hexagonal keys<br>1.25, 1.5, 2, 2.5, 3 mm   |   |                            |



| Code          | No. of Items | €             |   |
|---------------|--------------|---------------|---|
| <b>192386</b> | 155          | <b>255,35</b> | 2 |

## 1/4" y 1/2" sq. dr. socket set

Cr-V  
STEEL

Extending  
ratchet  
handle 1/4"  
and 1/2"



**BOX WITH  
CLOSURES AND  
METAL HINGES**



Box dimensions: 365x240x85 mm

### CONTENTS 1/2"

|  |                                 |                              |
|--|---------------------------------|------------------------------|
| 13 Sockets<br>10, 11, 12, 13, 14, 15,<br>17, 19, 22, 24, 27, 30, 32 mm | 2 Extension bars<br>125, 250 mm | 1 Coupler<br>3/8" F x 1/2" M |
| 1 Offset ratchet<br>handle 192344                                      | 1 Bit holder 5/16"              | 1 Socket holder<br>1/2"      |

### CONTENTS 1/4"

|  |                                |                              |
|--|--------------------------------|------------------------------|
| 12 Sockets<br>4, 4.5, 5, 5.5, 6, 7,<br>8, 9, 10, 11, 12, 13 mm                                     | 2 Extension bars<br>50, 100 mm | 1 Coupler<br>3/8" F x 1/4" M |
| 1 Offset ratchet<br>handle 192139  | 1 Socket bits<br>5/16"         | 1 Socket holder<br>1/4"      |
| 12 Insert bit sockets<br>2 4, 5, 5 mm  2 PH1,<br>PH2  5 T15, T20, T25<br>T27, T30  3 4, 5,<br>6 mm |                                |                              |
| 12 Bits 5/16"<br>2 7, 8 mm  2 PH3,<br>PH4  5 T40, T45, T50<br>T55, T60  3 8, 10, 12 mm             |                                |                              |
| 5 Hexagonal keys<br>1'25, 1'5, 2, 2'5, 3 mm  |                                |                              |



| Code          | No. of Items | €             |   |
|---------------|--------------|---------------|---|
| <b>192389</b> | 66           | <b>126,86</b> | 1 |

## 1/2" sq. dr. socket set

Cr-V  
STEEL

Extending  
ratchet  
handle  
5°  
72 T



Box dimensions: 365x240x85 mm

### WITH ADAPTERS FOR POWER TOOL AND PNEUMATIC

#### CONTENTS

|    |                              |   |                           |   |                              |
|----|------------------------------|---|---------------------------|---|------------------------------|
| 1  | Offset ratchet handle 192344 | 1 | Universal joint           | 1 | Socket holder 1/2"           |
| 16 | Sockets 10 to 32 mm          | 1 | Coupler 3/8" F x 1/2" M   | 1 | Bit holder 5/16"             |
| 2  | Extension bars 125, 250 mm   | 1 | Magnetic bit holder 5/16" |   |                              |
| 24 | Bits 5/16"                   |   |                           |   |                              |
| 6  | 4, 5, 6, 8, 10, 12 mm        | 4 | 5.5, 7, 8, 10 mm          | 4 | PH1, PH2, PH3, PH4           |
|    |                              | 4 | PZ1, PZ2, PZ3, PZ4        | 6 | T30, T40, T45, T50, T55, T60 |



| Code          | No. of Items | €             |   |
|---------------|--------------|---------------|---|
| <b>192384</b> | 48           | <b>104,78</b> | 1 |

## 1/2" sq. dr. socket set - inches

Cr-V  
STEEL

Extending  
ratchet  
handle  
5°  
72 T



Box dimensions: 365x240x85 mm



### WITH ADAPTERS FOR POWER TOOL AND PNEUMATIC

#### CONTENTS

|    |  |   |                           |   |                              |
|----|--|---|---------------------------|---|------------------------------|
| 1  | Offset ratchet handle 192344   | 1 | Universal joint           | 2 | Extension bar 125, 250 mm    |
| 15 | Sockets 3/8", 7/16", 1/2", 9/16", 5/8", 11/16", 3/4", 13/16", 7/8", 15/16", 1", 1-1/16", 1-1/8", 1-3/16", 1-1/4" | 1 | Coupler 3/8" F x 1/2" M   | 1 | Socket holder 1/2"           |
| 24 | Bits 5/16"   | 2 | Magnetic bit holder 5/16" | 1 | Bit holder 5/16"             |
| 6  | 4, 5, 6, 8, 10, 12 mm  | 4 | 5.5, 7, 8, 10 mm          | 4 | PH1, PH2, PH3, PH4           |
|    |  | 4 | PZ1, PZ2, PZ3, PZ4        | 5 | T30, T40, T45, T50, T55, T60 |



| Code          | No. of Items | €             |   |
|---------------|--------------|---------------|---|
| <b>190240</b> | 47           | <b>104,78</b> | 1 |

## 1/2" sq. dr. socket set

Cr-V  
STEEL

Extending  
ratchet  
handle  
5°  
72 T



Box dimensions: 330x160x60 mm

### BOX WITH METAL CLOSURES AND HINGES

#### CONTENTS

|    |                          |   |   |
|----|--------------------------|---|---|
| 10 | Sockets 10 to 19 mm      | 1 | Bit holder 5/16"                            |
| 1  | Extension bar 125 mm     | 1 | Offset ratchet handle 192344                |
| 25 | Bits 5/16"               |   |   |
| 7  | 4, 5, 6, 7, 8, 10, 12 mm | 3 | 5.5, 6.5, 8 mm                              |
|    |                          | 3 | PH1, PH2, PH3                               |
|    |                          | 3 | PZ1, PZ2, PZ3                               |
|    |                          | 9 | T10, T15, T20, T25, T30, T40, T45, T50, T55 |



| Code          | No. of Items | €            |   |
|---------------|--------------|--------------|---|
| <b>192383</b> | 38           | <b>68,93</b> | 1 |

## 1/2" sq. dr. extendable ratchet handle

**Cr-V STEEL** **Extending ratchet handle** **5°** **72 T**

Hole for hanging

Bimaterial handle

Ring for adjusting the length of the ratchet handle

Quick release button

Reversible

Closed dustproof head to prevent damage to the inner mechanism of the ratchet

Drilled handle for a secure adjusting of the ratchet to different lengths

**POSSIBILITY TO SET RATCHET TO 6 DIFFERENT LENGTHS**

**1/2**

| Code          | L min./L max mm | €            |   |
|---------------|-----------------|--------------|---|
| <b>192344</b> | 302/442         | <b>41,31</b> | 3 |

## 1/2" sq. dr. flexible extendable ratchet handle

**Cr-V STEEL** **Extending ratchet handle** **5°** **72 T**

**FLEXIBLE HEAD WITH POSSIBILITY OF 180° TURN WITH 10 FIXED POSITIONS**

**POSSIBILITY TO SET RATCHET TO 6 DIFFERENT LENGTHS**

Same characteristics as the ratchet 192344

**1/2**

| Code          | L min./L max mm | €            |   |
|---------------|-----------------|--------------|---|
| <b>192347</b> | 302/442         | <b>46,66</b> | 3 |

## 1/2" sq. dr. metal ratchet handle



• With reversor and quick release

**1/2**

| Code          | L mm | €            |   |
|---------------|------|--------------|---|
| <b>192343</b> | 270  | <b>33,22</b> | 3 |

Display with hanger

## 1/2" stubby ratchet handle



• With reversor and quick release

**1/2**

| Code          | L mm | €            |   |
|---------------|------|--------------|---|
| <b>192348</b> | 174  | <b>22,13</b> | 3 |

Display with hanger



## 1/2" sq. dr. socket

DIN 3124

Cr-V STEEL

• Satin finish

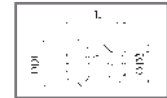

| Code   | mm      | L mm | D1 mm | D2 mm | €    |   |
|--------|---------|------|-------|-------|------|---|
| 190202 | 3/8"    | 38   | 15,2  | 21,8  | 3,94 | 1 |
| 190204 | 7/16"   | 38   | 16,5  | 21,8  | 4,01 | 1 |
| 190206 | 1/2"    | 38   | 19,9  | 21,8  | 4,23 | 1 |
| 190208 | 9/16"   | 38   | 20,1  | 21,8  | 4,79 | 1 |
| 190210 | 5/8"    | 38   | 21,8  | 21,8  | 4,90 | 1 |
| 190212 | 11/16"  | 38   | 23,8  | 23,9  | 5,10 | 1 |
| 190214 | 3/4"    | 38   | 25,8  | 24,8  | 5,26 | 1 |
| 190216 | 13/16"  | 38   | 27,7  | 25,9  | 5,83 | 1 |
| 190218 | 7/8"    | 38   | 30,7  | 26,7  | 6,17 | 1 |
| 190220 | 15/16"  | 38   | 31,7  | 27,9  | 6,33 | 1 |
| 190222 | 1"      | 41   | 33,6  | 30,1  | 6,66 | 1 |
| 190224 | 1-1/16" | 42   | 34,6  | 30,5  | 7,25 | 1 |
| 190226 | 1-1/8"  | 42   | 35,7  | 31,1  | 7,53 | 1 |
| 190228 | 1-3/16" | 44   | 37,7  | 35,8  | 8,08 | 1 |
| 190230 | 1-1/4"  | 44   | 41,8  | 36,8  | 8,24 | 1 |

| Code   | mm | L mm | D1 mm | D2 mm | €    |    |
|--------|----|------|-------|-------|------|----|
| 192308 | 8  | 38   | 15,0  | 21,8  | 3,40 | 10 |
| 192310 | 10 | 38   | 15,0  | 21,8  | 3,94 | 10 |
| 192311 | 11 | 38   | 16,3  | 21,8  | 4,01 | 10 |
| 192312 | 12 | 38   | 17,6  | 21,8  | 4,23 | 10 |
| 192313 | 13 | 38   | 18,8  | 21,8  | 4,40 | 10 |
| 192314 | 14 | 38   | 20,4  | 21,8  | 4,79 | 10 |
| 192315 | 15 | 38   | 21,6  | 20,7  | 4,85 | 10 |
| 192316 | 16 | 38   | 22,8  | 21,5  | 4,91 | 10 |
| 192317 | 17 | 38   | 23,8  | 22    | 5,10 | 10 |
| 192318 | 18 | 38   | 25,4  | 23    | 5,10 | 10 |
| 192319 | 19 | 38   | 25,8  | 23    | 5,26 | 10 |
| 192320 | 20 | 38   | 27,8  | 24    | 5,83 | 10 |
| 192321 | 21 | 38   | 27,8  | 25    | 5,83 | 10 |
| 192322 | 22 | 38   | 29,8  | 26    | 6,17 | 10 |
| 192323 | 23 | 40   | 31,6  | 27    | 6,33 | 10 |
| 192324 | 24 | 42   | 31,8  | 28    | 6,66 | 10 |
| 192325 | 25 | 42   | 31,8  | 28    | 6,80 | 5  |
| 192326 | 26 | 42   | 31,8  | 28    | 7,02 | 5  |
| 192327 | 27 | 43   | 35,8  | 30    | 7,24 | 5  |
| 192328 | 28 | 46   | 39,8  | 32    | 7,35 | 5  |
| 192329 | 29 | 46   | 39,8  | 32    | 7,50 | 5  |
| 192330 | 30 | 46   | 39,8  | 34    | 8,08 | 5  |
| 192332 | 32 | 46   | 41,8  | 36    | 8,24 | 5  |

## 1/2" sq. dr. deep socket

DIN 3124

Cr-V STEEL

DEEP TYPE



| Code   | mm | L mm | D1 mm | D2 mm | €     |   |
|--------|----|------|-------|-------|-------|---|
| 192501 | 10 | 77   | 16    | 22    | 10,37 | 5 |
| 192502 | 11 | 77   | 17    | 22    | 10,52 | 5 |
| 192503 | 12 | 77   | 18    | 22    | 10,52 | 5 |
| 192504 | 13 | 77   | 20    | 22    | 10,73 | 5 |
| 192505 | 14 | 77   | 22    | 22    | 11,83 | 5 |
| 192506 | 15 | 77   | 22    | 22    | 11,83 | 5 |
| 192507 | 16 | 77   | 22    | 22    | 11,83 | 5 |
| 192508 | 17 | 77   | 24    | 24    | 11,83 | 5 |
| 192509 | 18 | 77   | 26    | 26    | 11,83 | 5 |
| 192510 | 19 | 77   | 26    | 26    | 11,83 | 5 |
| 192511 | 20 | 77   | 28    | 26    | 12,11 | 5 |
| 192512 | 21 | 77   | 28    | 26    | 12,11 | 5 |
| 192513 | 22 | 77   | 30    | 26    | 13,50 | 5 |
| 192514 | 24 | 77   | 32    | 28    | 14,09 | 5 |
| 192515 | 27 | 77   | 36    | 32    | 15,02 | 3 |
| 192516 | 30 | 77   | 40    | 36    | 17,22 | 3 |
| 192517 | 32 | 77   | 42    | 37    | 18,64 | 3 |

## 1/2" sq. dr. bihexagonal socket

DIN 3124

Cr-V STEEL



| Code   | mm | L mm | D1 mm | D2 mm | €    |    |
|--------|----|------|-------|-------|------|----|
| 190410 | 10 | 38   | 15,0  | 21,8  | 3,95 | 10 |
| 190411 | 11 | 38   | 16,3  | 21,8  | 4,01 | 10 |
| 190412 | 12 | 38   | 17,6  | 21,8  | 4,23 | 10 |
| 190413 | 13 | 38   | 18,8  | 21,8  | 4,39 | 10 |
| 190414 | 14 | 38   | 20,4  | 21,8  | 4,79 | 10 |
| 190415 | 15 | 38   | 21,6  | 20,7  | 4,85 | 10 |
| 190416 | 16 | 38   | 22,8  | 21,5  | 4,91 | 10 |
| 190417 | 17 | 38   | 23,8  | 22    | 5,10 | 10 |
| 190418 | 18 | 38   | 25,4  | 23    | 5,10 | 10 |
| 190419 | 19 | 38   | 25,8  | 23    | 5,26 | 10 |
| 190420 | 20 | 38   | 27,8  | 24    | 5,83 | 10 |
| 190421 | 21 | 38   | 27,8  | 25    | 5,83 | 10 |
| 190422 | 22 | 38   | 29,8  | 26    | 6,17 | 10 |
| 190423 | 23 | 40   | 31,6  | 27    | 6,33 | 10 |
| 190424 | 24 | 42   | 31,8  | 28    | 6,66 | 10 |
| 190427 | 27 | 43   | 35,8  | 30    | 7,23 | 5  |
| 190430 | 30 | 46   | 39,8  | 34    | 8,08 | 5  |
| 190432 | 32 | 46   | 41,8  | 36    | 8,24 | 5  |

## 1/2" sq. dr. Torx socket (E-type)

Cr-V  
STEEL



• Satin finish



| Code          | ★   | L mm | €           | ☞  |
|---------------|-----|------|-------------|----|
| <b>192294</b> | E10 | 38   | <b>5,14</b> | 10 |
| <b>192295</b> | E12 | 38   | <b>5,14</b> | 10 |
| <b>192296</b> | E14 | 38   | <b>5,14</b> | 10 |
| <b>192297</b> | E16 | 38   | <b>5,32</b> | 10 |
| <b>192298</b> | E18 | 38   | <b>5,32</b> | 10 |
| <b>192299</b> | E20 | 38   | <b>5,73</b> | 10 |
| <b>192300</b> | E24 | 38   | <b>6,33</b> | 10 |

## 1/2" sq. dr. Sockets in plastic rack



REGULAR TYPE

### CONTENTS

- **192333** 10, 11, 12, 13, 14, 15, 16, 17, 18, 19 mm
- **192334** 17, 19, 20, 21, 22, 24, 27, 30, 32 mm

| Code          | No. of Items | €            | ☞ |
|---------------|--------------|--------------|---|
| <b>192333</b> | 10           | <b>38,00</b> | 1 |
| <b>192334</b> | 9            | <b>43,00</b> | 1 |



DEEP TYPE

### CONTENTS

10, 11, 13, 14, 15, 16, 17, 19, 21, 22 mm

| Code          | No. of Items | €            | ☞ |
|---------------|--------------|--------------|---|
| <b>192518</b> | 10           | <b>93,00</b> | 1 |



### CONTENTS

10, 11, 13, 14, 15, 16, 17, 19, 21, 22 mm

| Code          | No. of Items | €            | ☞ |
|---------------|--------------|--------------|---|
| <b>190433</b> | 10           | <b>36,00</b> | 1 |

## 1/2" sq. dr. socket displayer



Displayer length: 770 mm

### CONTENTS

- 150** 1/2" dr. sockets (10 units of each size)  
192310, 192311, 192312, 192313, 192314, 192315, 192316, 192317, 192318, 192319, 192320, 192321, 192322, 192323, 192324
- 40** 1/2" dr. sockets (5 units of each size)  
192327, 192330, 192332,  
192501, 192504, 192508, 192510, 192514 (long)
- 1 socket displayer
- 23 metal dividers



| Code          | No. of Items | €               | ☞ |
|---------------|--------------|-----------------|---|
| <b>192305</b> | 190          | <b>1.188,98</b> | 1 |

## Accessories for 1/2" sockets

Cr-V  
STEEL

• Chromed satin finish

1/2"

### 1/2" hinged handle



The joint can be wivelled to different angles between 0° and 180°

| Code          | L mm | €            |   |
|---------------|------|--------------|---|
| <b>192362</b> | 385  | <b>23,73</b> | 1 |

### 1/2" extension bar

DIN  
3123



With external hexagon

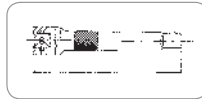

| Code          | L mm | €            |   |
|---------------|------|--------------|---|
| <b>192352</b> | 75   | <b>6,38</b>  | 6 |
| <b>192355</b> | 125  | <b>7,43</b>  | 6 |
| <b>192356</b> | 150  | <b>8,27</b>  | 6 |
| <b>192358</b> | 250  | <b>12,22</b> | 6 |

### 1/2" locking extension bar



#### INSTRUCTIONS FOR USE



Retract the knurled ring for unlocking. Socket can be removed.



When the knurled ring is down the extension bar is locked. Socket cannot be removed.

| Code          | L mm | €            |   |
|---------------|------|--------------|---|
| <b>192359</b> | 125  | <b>11,51</b> | 5 |

This system allows a security holding between socket and extension bar.

### 1/2" sliding tee handle

DIN  
3122



| Code          | L mm | €            |   |
|---------------|------|--------------|---|
| <b>192360</b> | 250  | <b>15,35</b> | 6 |

### 1/2" universal joint

DIN  
3123

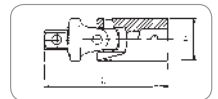

| Code          | L mm | €            |   |
|---------------|------|--------------|---|
| <b>192365</b> | 73,5 | <b>21,00</b> | 6 |

### 1/2" coupler

DIN  
3123



| Code          | Female | Male | €            |    |
|---------------|--------|------|--------------|----|
| <b>192620</b> | 1/2" * | 3/8" | <b>8,56</b>  | 10 |
| <b>192625</b> | 1/2"   | 3/4" | <b>11,86</b> | 10 |

With hole for using as T-handle

### 1/2" bit holder

DIN  
3121



For 1/2" ratchet  
For 5/16"



For 1/2" ratchet  
For 3/8"

| Code          | for bits | €           |   |
|---------------|----------|-------------|---|
| <b>192363</b> | 5/16"    | <b>7,02</b> | 6 |
| <b>186187</b> | 3/8"     | <b>6,89</b> | 6 |

## 1/2" sq. dr. hexagonal insert bit socket

DIN 3121

Cr-V STEEL



| Code   | mm | L mm | €     |    |
|--------|----|------|-------|----|
| 192405 | 5  | 55   | 7,21  | 10 |
| 192406 | 6  | 55   | 7,21  | 10 |
| 192407 | 7  | 55   | 7,34  | 10 |
| 192408 | 8  | 55   | 7,41  | 10 |
| 192409 | 9  | 55   | 7,46  | 10 |
| 192410 | 10 | 55   | 7,49  | 10 |
| 192412 | 12 | 55   | 7,73  | 10 |
| 192414 | 14 | 55   | 8,59  | 10 |
| 192417 | 17 | 55   | 11,02 | 10 |

## 1/2" socket set

HEX BITS



### CONTENTS

5, 6, 7, 8, 9, 10, 12, 14, 17 mm

| Code   | No. of Items | €     |   |
|--------|--------------|-------|---|
| 192470 | 9            | 59,00 | 1 |

## 1/2" Torx insert bit socket

DIN 3121

Cr-V STEEL



| Code   |     | L mm | €    |    |
|--------|-----|------|------|----|
| 190720 | T20 | 55   | 8,43 | 10 |
| 190725 | T25 | 55   | 8,46 | 10 |
| 190727 | T27 | 55   | 8,53 | 10 |
| 190730 | T30 | 55   | 8,56 | 10 |
| 190740 | T40 | 55   | 8,60 | 10 |
| 190745 | T45 | 55   | 8,73 | 10 |
| 190750 | T50 | 55   | 9,27 | 10 |
| 190755 | T55 | 55   | 9,31 | 10 |
| 190760 | T60 | 55   | 9,49 | 10 |

## 1/2" Torx tapered insert bit socket

DIN 3121

Cr-V STEEL



| Code   |     | L mm | €    |    |
|--------|-----|------|------|----|
| 192420 | T20 | 55   | 8,43 | 10 |
| 192425 | T25 | 55   | 8,46 | 10 |
| 192427 | T27 | 55   | 8,53 | 10 |
| 192430 | T30 | 55   | 8,56 | 10 |
| 192440 | T40 | 55   | 8,60 | 10 |
| 192445 | T45 | 55   | 8,73 | 10 |
| 192450 | T50 | 55   | 9,27 | 10 |
| 192455 | T55 | 55   | 9,30 | 10 |
| 192460 | T60 | 55   | 9,49 | 10 |

## 1/2" insert bit socket set

TORX TAMPERED BITS



### CONTENTS

T20, T25, T27, T30, T40, T45, T50, T55, T60

| Code   | No. of Items | €     |   |
|--------|--------------|-------|---|
| 192480 | 9            | 64,00 | 1 |

## 1/2" Torx insert bit socket set

TORX BITS



### CONTENTS

T20, T25, T27, T30, T40, T45, T50, T55, T60

| Code   | No. of Items | €     |   |
|--------|--------------|-------|---|
| 190765 | 9            | 64,00 | 1 |



## 1/2" insert bit socket, XZN

DIN 3120

Cr-V STEEL



| Code   |     | L mm | €     |    |
|--------|-----|------|-------|----|
| 192481 | M6  | 55   | 9,47  | 10 |
| 192482 | M8  | 55   | 9,66  | 10 |
| 192483 | M10 | 55   | 9,97  | 10 |
| 192484 | M12 | 55   | 10,63 | 10 |
| 192485 | M14 | 55   | 11,02 | 10 |
| 192486 | M16 | 55   | 12,31 | 10 |

## 1/2" insert bit socket, RIBE

DIN 3120

Cr-V STEEL



| Code   |     | L mm | €     |    |
|--------|-----|------|-------|----|
| 190767 | M7  | 55   | 9,47  | 10 |
| 190770 | M10 | 55   | 9,66  | 10 |
| 190774 | M14 | 55   | 9,97  | 10 |
| 190776 | M16 | 55   | 12,30 | 10 |

## 1/2" insert bit socket, Hex long

DIN 3121

Cr-V STEEL



| Code   |    | L mm | €     |    |
|--------|----|------|-------|----|
| 190705 | 5  | 100  | 7,21  | 10 |
| 190706 | 6  | 100  | 7,21  | 10 |
| 190707 | 7  | 100  | 7,34  | 10 |
| 190708 | 8  | 100  | 7,41  | 10 |
| 190710 | 10 | 100  | 7,46  | 10 |
| 190712 | 12 | 100  | 11,02 | 10 |

## 1/2" insert bit socket, Torx long

DIN 3121

Cr-V STEEL



| Code   |     | L mm | €     |    |
|--------|-----|------|-------|----|
| 190741 | T40 | 100  | 7,21  | 10 |
| 190746 | T45 | 100  | 7,34  | 10 |
| 190751 | T50 | 100  | 7,41  | 10 |
| 190756 | T55 | 100  | 7,46  | 10 |
| 190761 | T70 | 100  | 11,02 | 10 |

## 1/2" insert bit socket, XZN long

DIN 3121

Cr-V STEEL



| Code   |     | L mm | €     |    |
|--------|-----|------|-------|----|
| 192475 | M6  | 100  | 7,34  | 10 |
| 192476 | M8  | 100  | 7,41  | 10 |
| 192477 | M10 | 100  | 7,46  | 10 |
| 192478 | M12 | 100  | 11,02 | 10 |

## 1/2" insert bit socket, RIBE long

DIN 3121

Cr-V STEEL



| Code   |     | L mm | €     |    |
|--------|-----|------|-------|----|
| 190768 | M7  | 100  | 7,34  | 10 |
| 190771 | M10 | 100  | 7,41  | 10 |
| 190775 | M14 | 100  | 7,46  | 10 |
| 190777 | M16 | 100  | 11,02 | 10 |

## 1/4" insulated socket set



Cr-V  
STEEL



## VDE Certificate

### EN 60900 STANDARD

Insulated tools used for jobs on voltages of up to 1000 V in AC current or up to 1500 V in DC.



### CONTENTS

- 10 1/4" insulated sockets 5 to 14 mm.
- 2 Insulated extension bars 100, 150 mm
- 4 1/4" insulated socket hex tip 3 to 6 mm.
- 1 Insulated T handle 125 mm
- 1 Insulated ratchet handle

| Code          | No. of Items | €             |   |
|---------------|--------------|---------------|---|
| <b>190302</b> | 18           | <b>192,76</b> | 1 |

## Insulated 1/4" sq. dr. ratchet handle



## VDE Certificate



- Handle and body covered with insulating material
- Reversible and quick release ratchet handle
- Bimaterial ergonomic handle



| Code          | L mm | €            |   |
|---------------|------|--------------|---|
| <b>190390</b> | 150  | <b>39,20</b> | 1 |

## Insulated 1/4" sq. dr. socket



| Code          | mm | L mm | €           |   |
|---------------|----|------|-------------|---|
| <b>190383</b> | 3  | 55   | <b>6,01</b> | 1 |
| <b>190384</b> | 4  | 55   | <b>6,01</b> | 1 |
| <b>190385</b> | 5  | 55   | <b>6,01</b> | 1 |
| <b>190386</b> | 6  | 55   | <b>6,01</b> | 1 |



## VDE Certificate



| Code          | mm | L mm | €           |   |
|---------------|----|------|-------------|---|
| <b>190365</b> | 5  | 40   | <b>4,98</b> | 1 |
| <b>190366</b> | 6  | 40   | <b>4,98</b> | 1 |
| <b>190367</b> | 7  | 40   | <b>4,98</b> | 1 |
| <b>190368</b> | 8  | 40   | <b>4,98</b> | 1 |
| <b>190369</b> | 9  | 40   | <b>4,98</b> | 1 |
| <b>190370</b> | 10 | 40   | <b>4,98</b> | 1 |
| <b>190371</b> | 11 | 40   | <b>5,08</b> | 1 |
| <b>190372</b> | 12 | 40   | <b>5,12</b> | 1 |
| <b>190373</b> | 13 | 40   | <b>5,19</b> | 1 |
| <b>190374</b> | 14 | 40   | <b>5,21</b> | 1 |

## Insulated extension bar



190392

190391

## VDE Certificate



| Code          | Type             | L mm | €            |   |
|---------------|------------------|------|--------------|---|
| <b>190392</b> | <b>EXTENSION</b> | 100  | <b>16,83</b> | 1 |
| <b>190393</b> | <b>EXTENSION</b> | 150  | <b>18,89</b> | 1 |
| <b>190391</b> | <b>T HANDLE</b>  | 125  | <b>29,20</b> | 1 |

## Insulated 1/2" socket set



Cr-V  
STEEL



## VDE Certificate

### EN 60900 STANDARD

Insulated tools used for jobs on voltages of up to 1000 V in AC current or up to 1500 V in DC.



### CONTENTS

|    |  |   |                                      |   |                    |   |                          |
|----|--|---|--------------------------------------|---|--------------------|---|--------------------------|
| 11 | 1/2" insulated sockets 10 to 32 mm.        | 2 | Insulated extension bars 125, 250 mm | 1 | Insulated T handle | 1 | Insulated ratchet handle |
| 5  | 1/2" insulated sockets hex tip 4 to 10 mm. |   |                                      |   |                    |   |                          |

| Code          | No. of Items | €             |   |
|---------------|--------------|---------------|---|
| <b>190300</b> | 20           | <b>307,18</b> | 1 |

## Insulated 1/2" sq. dr. ratchet handle



## VDE Certificate



- Handle and body covered with insulating material
- Reversible and quick release ratchet handle
- Bimaterial ergonomic handle



| Code          | L mm | €            |   |
|---------------|------|--------------|---|
| <b>190305</b> | 250  | <b>68,48</b> | 1 |

## Insulated 1/2" sq. dr. socket

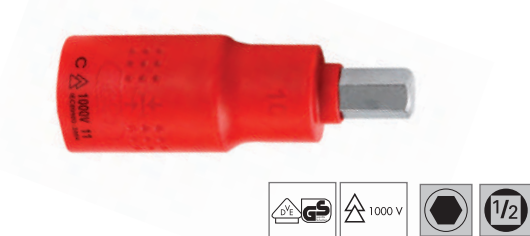

## VDE Certificate



| Code          | mm | L mm | €           |   |
|---------------|----|------|-------------|---|
| <b>190354</b> | 4  | 75   | <b>8,46</b> | 2 |
| <b>190355</b> | 5  | 75   | <b>8,46</b> | 2 |
| <b>190356</b> | 6  | 75   | <b>8,46</b> | 2 |
| <b>190358</b> | 8  | 75   | <b>8,46</b> | 2 |
| <b>190360</b> | 10 | 75   | <b>9,60</b> | 2 |



| Code          | mm | L mm | €            |   |
|---------------|----|------|--------------|---|
| <b>190310</b> | 10 | 55   | <b>6,44</b>  | 3 |
| <b>190311</b> | 11 | 55   | <b>6,44</b>  | 3 |
| <b>190312</b> | 12 | 55   | <b>6,44</b>  | 3 |
| <b>190313</b> | 13 | 55   | <b>6,44</b>  | 3 |
| <b>190314</b> | 14 | 55   | <b>6,44</b>  | 3 |
| <b>190317</b> | 17 | 55   | <b>6,74</b>  | 3 |
| <b>190319</b> | 19 | 57   | <b>6,91</b>  | 3 |
| <b>190322</b> | 22 | 57   | <b>7,63</b>  | 3 |
| <b>190324</b> | 24 | 57   | <b>8,17</b>  | 3 |
| <b>190327</b> | 27 | 59   | <b>10,25</b> | 2 |
| <b>190332</b> | 32 | 59   | <b>11,92</b> | 2 |

## Insulated extension bar and T handle



## VDE Certificate



| Code          | Type             | L mm | €            |   |
|---------------|------------------|------|--------------|---|
| <b>190342</b> | <b>EXTENSION</b> | 125  | <b>24,80</b> | 1 |
| <b>190345</b> | <b>EXTENSION</b> | 250  | <b>30,53</b> | 1 |
| <b>190340</b> | <b>T HANDLE</b>  | 250  | <b>38,68</b> | 1 |

## Impact screwdriver set

Cr-V  
STEEL



- Handle made of antislip rubber
- Chrome plated finish
- Metallic end for striking

1/2



Box Dimensions: 330x160x60 mm

### INCLUDES:



192648

192649

### CONTENTS

- 1 Reinforced impact driver 1/2" dr.
- 1 Coupler 1/2" M x 5/16" M
- 1 Bit holder 5/16" F x 3/8" F
- 18 Impact bits 5/16" H x 36 mm
- 4 4, 5, 6, 8 mm
- 4 6, 8, 10, 12 mm
- 4 PH1, PH2, PH3, PH4
- 6 PZ1, PZ2, PZ3, PZ4

| Code   | No. of Items | €     |   |
|--------|--------------|-------|---|
| 192650 | 21           | 45,89 | 1 |

## Impact screwdriver set with adaptors

Cr-V  
STEEL



- Phosphated finish

1/2

### INCLUDES:



192648

192649

### CONTENTS

- 1 1/2" heavy duty impact driver
- 1 Adapter of 1/2" M x 5/16" M
- 1 bit holder of 5/16" F x 3/8" F

| Code   | No. of Items | €     |   |
|--------|--------------|-------|---|
| 192652 | 3            | 22,42 | 1 |

## Hexagonal coupler



## Bit holder



| Code   | ■    | ■     | €    |   |
|--------|------|-------|------|---|
| 192648 | 3/8" | 5/16" | 1,78 | 6 |

| Code   | ○     | □    | €    |   |
|--------|-------|------|------|---|
| 192649 | 5/16" | 1/2" | 1,34 | 6 |

## 3/4" sq. dr. socket set

Cr-V  
STEEL



Box Dimensions: 540x180x80 mm

- Phosphated finish

3/4

### CONTENTS

- 1 Ratchet handle with removable handle
- 1 1" dr. sliding Tee bar 400 mm
- 14 Sockets 19, 21, 22, 24, 27, 30, 32, 33, 34, 36, 38, 41, 46, 50 mm
- 2 Extension bars 200, 400 mm

| Code   | No. of Items | €      |   |
|--------|--------------|--------|---|
| 192580 | 18           | 344,82 | 1 |

## 3/4" sq. dr. ratchet handle

DIN 3122



Cr-V STEEL



### REMOVABLE HANDLE

- With reversor and quick release
- Rough finish metallic handle
- Satin finish coating



| Code          | L mm | €            |   |
|---------------|------|--------------|---|
| <b>192555</b> | 495  | <b>98,00</b> | 1 |

## 3/4" bihexagonal socket

DIN 3124

Cr-V STEEL

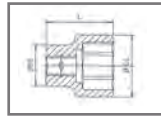

• Satin finish



| Code          | mm | L mm | D1 mm | D2 mm | €            |   |
|---------------|----|------|-------|-------|--------------|---|
| <b>192519</b> | 19 | 50   | 29    | 33    | <b>10,10</b> | 1 |
| <b>192521</b> | 21 | 50   | 31    | 33    | <b>10,10</b> | 1 |
| <b>192522</b> | 22 | 50   | 32    | 36    | <b>10,10</b> | 1 |
| <b>192524</b> | 24 | 51   | 34    | 36    | <b>10,71</b> | 1 |

| Code          | mm | L mm | D1 mm | D2 mm | €            |   |
|---------------|----|------|-------|-------|--------------|---|
| <b>192527</b> | 27 | 52   | 38    | 36    | <b>11,13</b> | 1 |
| <b>192530</b> | 30 | 54   | 42    | 38    | <b>12,44</b> | 1 |
| <b>192532</b> | 32 | 56   | 44    | 38    | <b>12,79</b> | 1 |
| <b>192533</b> | 33 | 56   | 46    | 38    | <b>14,16</b> | 1 |
| <b>192534</b> | 34 | 56   | 47    | 38    | <b>14,16</b> | 1 |
| <b>192536</b> | 36 | 58   | 50    | 42    | <b>14,51</b> | 1 |
| <b>192538</b> | 38 | 60   | 52    | 45    | <b>16,14</b> | 1 |
| <b>192541</b> | 41 | 64   | 56    | 45    | <b>17,61</b> | 1 |
| <b>192546</b> | 46 | 68   | 62    | 48    | <b>20,85</b> | 1 |
| <b>192550</b> | 50 | 72   | 68    | 48    | <b>23,90</b> | 1 |

## 3/4" extension bar

DIN 3123

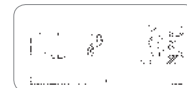

| Code          | L mm | €            |   |
|---------------|------|--------------|---|
| <b>192565</b> | 100  | <b>15,28</b> | 1 |
| <b>192570</b> | 200  | <b>21,36</b> | 1 |
| <b>192575</b> | 400  | <b>34,71</b> | 1 |

## 3/4" T handle

DIN 3122



| Code          | L mm | €            |   |
|---------------|------|--------------|---|
| <b>192560</b> | 450  | <b>32,98</b> | 1 |

## 3/4" coupler

DIN 3123



| Code          | Female | Male | €            |   |
|---------------|--------|------|--------------|---|
| <b>192630</b> | 3/4"   | 1/2" | <b>16,13</b> | 1 |
| <b>192632</b> | 3/4"   | 1"   | <b>19,60</b> | 1 |

## 1" sq. dr. socket set



Box Dimensions: 650x210x110 mm

• Satin finish



### CONTENTS

- 1 Ratchet handle with removable handle
- 1 1" dr. sliding Tee bar 400 mm
- 14 Sockets  
19, 21, 22, 24, 27, 30, 32, 33, 34, 36, 38, 41, 46, 50 mm
- 2 Extension bars  
200, 400 mm

| Code          | No. of Items | €             |   |
|---------------|--------------|---------------|---|
| <b>194820</b> | 14           | <b>742,76</b> | 1 |

## 1" sq. dr. ratchet handle

DIN 3122



### REMOVABLE HANDLE



| Code          | L mm | €             |   |
|---------------|------|---------------|---|
| <b>194885</b> | 660  | <b>172,60</b> | 1 |

## 1" sq. dr. bihexagonal socket

DIN 3124

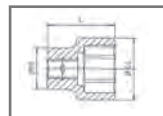

• Chrome-plated finish



| Code          | Ø mm | L mm | D1 mm | D2 mm | €            |   |
|---------------|------|------|-------|-------|--------------|---|
| <b>194836</b> | 36   | 65   | 52    | 45    | <b>20,25</b> | 1 |
| <b>194841</b> | 41   | 70   | 57    | 45    | <b>24,55</b> | 1 |
| <b>194846</b> | 46   | 75   | 65    | 50    | <b>29,06</b> | 1 |
| <b>194850</b> | 50   | 75   | 70    | 55    | <b>33,33</b> | 1 |
| <b>194855</b> | 55   | 80   | 76    | 57    | <b>38,06</b> | 1 |
| <b>194860</b> | 60   | 85   | 85    | 57    | <b>46,31</b> | 1 |
| <b>194865</b> | 65   | 87   | 87    | 57    | <b>55,34</b> | 1 |
| <b>194870</b> | 70   | 94   | 94    | 68    | <b>62,35</b> | 1 |
| <b>194875</b> | 75   | 98   | 100   | 68    | <b>69,84</b> | 1 |
| <b>194880</b> | 80   | 102  | 105   | 68    | <b>79,98</b> | 1 |

## 1" extension bar

DIN 3123



| Code          | L mm | €            |   |
|---------------|------|--------------|---|
| <b>194886</b> | 200  | <b>44,34</b> | 1 |
| <b>194887</b> | 400  | <b>45,26</b> | 1 |

## 1" T handle

DIN 3122

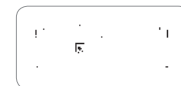

| Code          | L mm | €            |   |
|---------------|------|--------------|---|
| <b>194888</b> | 560  | <b>56,98</b> | 1 |

## 1" coupler

DIN 3123



| Code          | Female | Male | €            |   |
|---------------|--------|------|--------------|---|
| <b>194890</b> | 1"     | 3/4" | <b>26,61</b> | 1 |

## Impact sockets

Cr-Mo  
STEEL

6 Concentricity

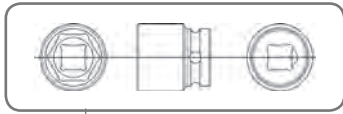

5 Special profile

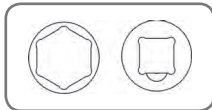

- 1 Made of high grade chrome alloy steel.
- 2 Proper heat treated.
- 3 Made to DIN standard.
- 4 Black finish.
- 5 Special small round corner design to reduce the inner stress and prevent damage the corner of hex nuts.
- 6 Both ends on a concentric line to reduce the vibration.
- 7 Slim and longer cut-down shank design.

7 Compact shaped

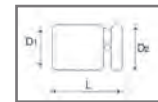
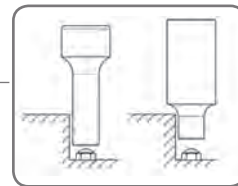

## 1/2" sq. dr. impact socket

DIN  
3129

Cr-Mo  
STEEL



| Code   | mm | L mm | D1 mm | D2 mm | €    |   |
|--------|----|------|-------|-------|------|---|
| 198208 | 8  | 38   | 15    | 25    | 5,11 | 1 |
| 198209 | 9  | 38   | 16    | 25    | 5,11 | 1 |
| 198210 | 10 | 38   | 17,5  | 25    | 5,11 | 1 |
| 198211 | 11 | 38   | 18,5  | 25    | 5,11 | 1 |
| 198212 | 12 | 38   | 20    | 25    | 5,11 | 1 |

| Code   | mm | L mm | D1 mm | D2 mm | €    |   |
|--------|----|------|-------|-------|------|---|
| 198213 | 13 | 38   | 21,2  | 25    | 5,11 | 1 |
| 198214 | 14 | 38   | 22,5  | 25    | 5,11 | 1 |
| 198215 | 15 | 38   | 23,7  | 30    | 5,70 | 1 |
| 198216 | 16 | 38   | 25    | 30    | 5,70 | 1 |
| 198217 | 17 | 38   | 26,2  | 30    | 5,70 | 1 |
| 198218 | 18 | 38   | 27,5  | 30    | 5,87 | 1 |
| 198219 | 19 | 38   | 28,7  | 30    | 5,87 | 1 |
| 198220 | 20 | 38   | 30    | 30    | 6,25 | 1 |
| 198221 | 21 | 39   | 31,2  | 30    | 6,51 | 1 |
| 198222 | 22 | 39   | 32,5  | 30    | 6,74 | 1 |
| 198223 | 23 | 41   | 33,7  | 30    | 6,74 | 1 |
| 198224 | 24 | 41   | 35    | 30    | 7,33 | 1 |
| 198227 | 27 | 44   | 38,7  | 30    | 7,59 | 1 |
| 198230 | 30 | 50   | 42,5  | 30    | 9,31 | 1 |
| 198232 | 32 | 50   | 45    | 30    | 9,99 | 1 |

## 1/2" impact sockets, plastic rack



### CONTENTS

10, 11, 13, 14, 15, 16, 17, 19, 21, 22 mm

| Code   | No. of Items | €     |   |
|--------|--------------|-------|---|
| 198233 | 10           | 56,65 | 1 |

## 1/2" sq. dr. deep impact socket

DIN 3129

Cr-Mo STEEL



DEEP TYPE



| Code          | mm | L mm | D1 mm | D2 mm | €           |   |
|---------------|----|------|-------|-------|-------------|---|
| <b>198240</b> | 10 | 80   | 17    | 25    | <b>8,83</b> | 1 |
| <b>198249</b> | 11 | 80   | 18,5  | 25    | <b>8,83</b> | 1 |
| <b>198250</b> | 12 | 80   | 20    | 25    | <b>8,83</b> | 1 |
| <b>198241</b> | 13 | 80   | 21    | 25    | <b>8,83</b> | 1 |
| <b>198251</b> | 14 | 80   | 22,5  | 30    | <b>9,00</b> | 1 |

| Code          | mm | L mm | D1 mm | D2 mm | €            |   |
|---------------|----|------|-------|-------|--------------|---|
| <b>198252</b> | 15 | 80   | 23,5  | 30    | <b>9,00</b>  | 1 |
| <b>198253</b> | 16 | 80   | 25    | 30    | <b>9,00</b>  | 1 |
| <b>198242</b> | 17 | 80   | 26,2  | 30    | <b>9,48</b>  | 1 |
| <b>198254</b> | 18 | 80   | 26,5  | 30    | <b>9,48</b>  | 1 |
| <b>198243</b> | 19 | 80   | 28,5  | 30    | <b>9,48</b>  | 1 |
| <b>198255</b> | 20 | 80   | 30    | 30    | <b>10,00</b> | 1 |
| <b>198256</b> | 21 | 80   | 31    | 30    | <b>10,00</b> | 1 |
| <b>198244</b> | 22 | 80   | 32    | 30    | <b>10,54</b> | 1 |
| <b>198245</b> | 24 | 80   | 32    | 30    | <b>11,45</b> | 1 |
| <b>198246</b> | 27 | 80   | 39    | 30    | <b>13,10</b> | 1 |
| <b>198247</b> | 30 | 80   | 42,5  | 30    | <b>14,96</b> | 1 |
| <b>198248</b> | 32 | 80   | 51    | 30    | <b>18,14</b> | 1 |

## 1/2 " deep impact socket set



### CONTENTS

10, 11, 13, 14, 15, 16, 17, 19, 21, 22 mm

| Code          | No. of Items | €            |   |
|---------------|--------------|--------------|---|
| <b>198258</b> | 10           | <b>89,00</b> | 1 |

## 1/2" sq. dr. type E impact socket

DIN 3129

Cr-Mo STEEL



TORX FEMALE



| Code          |     | L mm | €           |    |
|---------------|-----|------|-------------|----|
| <b>198200</b> | E10 | 38   | <b>5,89</b> | 10 |
| <b>198201</b> | E12 | 38   | <b>5,89</b> | 10 |
| <b>198202</b> | E14 | 38   | <b>5,89</b> | 10 |
| <b>198203</b> | E16 | 38   | <b>5,89</b> | 10 |
| <b>198204</b> | E18 | 38   | <b>5,89</b> | 10 |
| <b>198205</b> | E20 | 38   | <b>6,07</b> | 10 |
| <b>198206</b> | E24 | 38   | <b>6,80</b> | 10 |



## 1/2" impact socket for wheels

Cr-Mo  
STEEL



• Exterior plastic coating to avoid damaging the tyre



| Code          | mm | L mm | Ø mm | €           |   |
|---------------|----|------|------|-------------|---|
| <b>198902</b> | 17 | 85   | 30   | <b>8,64</b> | 1 |
| <b>198904</b> | 19 | 85   | 30   | <b>8,64</b> | 1 |
| <b>198906</b> | 21 | 85   | 30   | <b>8,64</b> | 1 |

## 1/2" impact socket set

Cr-Mo  
STEEL



**CONTENTS** 17, 19, 21 mm

| Code          | No. of Items | €            |   |
|---------------|--------------|--------------|---|
| <b>198900</b> | 3            | <b>27,92</b> | 1 |

Box Dimensions: 143x121x49 mm

## 1/2" impact extension bar

DIN  
3121

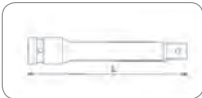

| Code          | L mm | €            |   |
|---------------|------|--------------|---|
| <b>198260</b> | 75   | <b>8,24</b>  | 1 |
| <b>198262</b> | 125  | <b>10,04</b> | 1 |
| <b>198265</b> | 250  | <b>14,34</b> | 1 |

## 3/4" impact universal joint

DIN  
3121

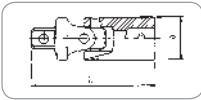

| Code          | L mm | €            |   |
|---------------|------|--------------|---|
| <b>198270</b> | 67   | <b>19,25</b> | 1 |

## 3/4" impact coupler

DIN  
3121



| Code          | Female | Male | L mm | €            |   |
|---------------|--------|------|------|--------------|---|
| <b>198275</b> | 1/2"   | 3/4" | 49   | <b>10,26</b> | 1 |

## 1/2" impact socket, hexagonal tip

DIN 3129

Cr-Mo STEEL



HEX TIP



| Code   | mm | L mm | D mm | €     |   |
|--------|----|------|------|-------|---|
| 198285 | 5  | 78   | 25   | 11,34 | 1 |
| 198286 | 6  | 78   | 25   | 11,42 | 1 |
| 198288 | 8  | 78   | 25   | 11,52 | 1 |
| 198290 | 10 | 78   | 25   | 11,89 | 1 |
| 198292 | 12 | 78   | 25   | 11,99 | 1 |
| 198294 | 14 | 78   | 30   | 12,27 | 1 |
| 198297 | 17 | 78   | 30   | 12,66 | 1 |
| 198299 | 19 | 78   | 30   | 13,49 | 1 |

## 1/2" impact socket, Torx tip

DIN 3129

Cr-Mo STEEL



TORX TIP

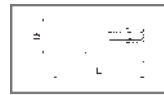

| Code   | mm  | L mm | D mm | €     |   |
|--------|-----|------|------|-------|---|
| 198302 | T25 | 78   | 25   | 11,52 | 1 |
| 198304 | T27 | 78   | 25   | 11,52 | 1 |
| 198306 | T30 | 78   | 25   | 11,52 | 1 |
| 198308 | T40 | 78   | 25   | 11,63 | 1 |
| 198310 | T45 | 78   | 25   | 11,63 | 1 |
| 198312 | T50 | 78   | 25   | 11,63 | 1 |
| 198314 | T55 | 78   | 25   | 12,04 | 1 |
| 198316 | T60 | 78   | 25   | 12,04 | 1 |

## 1/2" impact socket set, plastic rack



HEX TIP



### CONTENTS

5, 6, 8, 10, 12, 14, 17, 19 mm

| Code   | No. of Items | €     |   |
|--------|--------------|-------|---|
| 198300 | 8            | 96,59 | 1 |

## 1/2" impact socket set, plastic rack



TORX TIP



### CONTENTS

T25, T27, T30, T40, T45, T50, T55, T60

| Code   | No. of Items | €     |   |
|--------|--------------|-------|---|
| 198301 | 8            | 93,53 | 1 |

## 1/2" impact socket XZN

DIN 3129

Cr-Mo STEEL



XZN TIP



| Code   | mm  | L mm | Ø mm | €     |   |
|--------|-----|------|------|-------|---|
| 198180 | M6  | 78   | 25   | 10,66 | 1 |
| 198181 | M8  | 78   | 25   | 10,95 | 1 |
| 198182 | M10 | 78   | 25   | 11,50 | 1 |
| 198183 | M12 | 78   | 25   | 11,50 | 1 |
| 198184 | M14 | 78   | 25   | 11,80 | 1 |
| 198185 | M16 | 78   | 25   | 12,08 | 1 |

## 3/4" sq. dr. impact socket

DIN 3129

Cr-Mo STEEL



REGULAR TYPE

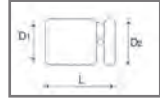

| Code   | mm | L mm | D1 mm | D2 mm | €     |   |
|--------|----|------|-------|-------|-------|---|
| 198317 | 17 | 51   | 30    | 44    | 11,54 | 1 |
| 198319 | 19 | 51   | 32,5  | 44    | 11,54 | 1 |
| 198321 | 21 | 51   | 35    | 44    | 11,75 | 1 |
| 198322 | 22 | 51   | 36    | 44    | 11,96 | 1 |
| 198324 | 24 | 51   | 38,5  | 44    | 11,96 | 1 |
| 198327 | 27 | 53   | 42,5  | 44    | 11,96 | 1 |
| 198330 | 30 | 53   | 46    | 44    | 12,17 | 1 |
| 198332 | 32 | 57   | 48,5  | 44    | 12,69 | 1 |
| 198334 | 34 | 57   | 51    | 44    | 14,80 | 1 |
| 198336 | 36 | 57   | 53,5  | 44    | 15,18 | 1 |
| 198338 | 38 | 57   | 56    | 44    | 16,01 | 1 |
| 198341 | 41 | 58   | 60    | 44    | 18,23 | 1 |
| 198346 | 46 | 62   | 66    | 44    | 21,88 | 1 |
| 198350 | 50 | 68   | 71    | 44    | 26,54 | 1 |
| 198355 | 55 | 72   | 77,5  | 54    | 40,92 | 1 |
| 198360 | 60 | 72   | 83,5  | 54    | 40,92 | 1 |

DIN 3124

Cr-Mo STEEL



DEEP TYPE



| Code   | mm | L mm | D1 mm | D2 mm | €     |   |
|--------|----|------|-------|-------|-------|---|
| 198370 | 17 | 100  | 30    | 44    | 19,04 | 1 |
| 198371 | 19 | 100  | 33    | 44    | 19,04 | 1 |
| 198372 | 21 | 100  | 35    | 44    | 19,25 | 1 |
| 198373 | 22 | 100  | 36    | 44    | 19,25 | 1 |
| 198374 | 24 | 100  | 38    | 44    | 19,46 | 1 |
| 198375 | 27 | 100  | 42    | 44    | 19,46 | 1 |
| 198376 | 30 | 100  | 46    | 44    | 19,85 | 1 |
| 198377 | 32 | 100  | 48    | 44    | 20,25 | 1 |
| 198378 | 34 | 100  | 51    | 44    | 22,69 | 1 |
| 198379 | 36 | 100  | 53    | 44    | 22,90 | 1 |
| 198380 | 41 | 100  | 59    | 44    | 26,95 | 1 |

## 3/4" impact extension bar

DIN 3121

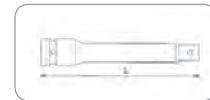

| Code   | L mm | €     |   |
|--------|------|-------|---|
| 198382 | 175  | 25,93 | 1 |
| 198384 | 250  | 31,81 | 1 |
| 198386 | 325  | 36,63 | 1 |

## 3/4" impact universal joint

DIN 3121

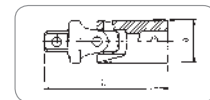

| Code   | L mm | €     |   |
|--------|------|-------|---|
| 198390 | 110  | 50,56 | 1 |

## 3/4" impact coupler

DIN 3121



| Code   | Female | Male | L mm | €     |   |
|--------|--------|------|------|-------|---|
| 198392 | 3/4"   | 1/2" | 56   | 16,62 | 1 |
| 198395 | 3/4"   | 1"   | 68   | 17,82 | 1 |

## 1"sq. dr. impact socket

DIN 3129

Cr-Mo STEEL



REGULAR TYPE

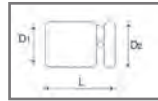

| Code   | mm | L mm | D1 mm | D2 mm | €     |   |
|--------|----|------|-------|-------|-------|---|
| 198424 | 24 | 57   | 41    | 54    | 20,34 | 1 |
| 198427 | 27 | 57   | 45    | 54    | 21,16 | 1 |
| 198430 | 30 | 60   | 49    | 54    | 21,75 | 1 |
| 198432 | 32 | 60   | 51    | 54    | 21,75 | 1 |
| 198434 | 34 | 64   | 54    | 54    | 21,75 | 1 |
| 198436 | 36 | 65   | 57    | 54    | 22,16 | 1 |
| 198438 | 38 | 66   | 59    | 54    | 23,36 | 1 |
| 198441 | 41 | 68   | 63    | 54    | 25,81 | 1 |
| 198446 | 46 | 73   | 69    | 54    | 31,90 | 1 |
| 198450 | 50 | 70   | 74    | 54    | 36,74 | 1 |
| 198455 | 55 | 75   | 81    | 54    | 43,43 | 1 |
| 198460 | 60 | 80   | 86    | 54    | 53,77 | 1 |
| 198465 | 65 | 92   | 92,5  | 54    | 62,35 | 1 |
| 198470 | 70 | 96   | 99    | 54    | 71,37 | 1 |

DIN 3129

Cr-Mo STEEL



DEEP TYPE



| Code   | mm | L mm | D1 mm | D2 mm | €     |   |
|--------|----|------|-------|-------|-------|---|
| 198475 | 24 | 108  | 41    | 54    | 29,10 | 1 |
| 198476 | 27 | 108  | 45    | 54    | 30,28 | 1 |
| 198477 | 30 | 108  | 48    | 54    | 30,28 | 1 |
| 198478 | 32 | 108  | 51    | 54    | 30,28 | 1 |
| 198479 | 34 | 108  | 54    | 54    | 30,28 | 1 |
| 198480 | 36 | 108  | 56    | 54    | 35,52 | 1 |
| 198481 | 38 | 108  | 59    | 54    | 35,52 | 1 |
| 198482 | 41 | 108  | 62    | 54    | 39,57 | 1 |
| 198483 | 46 | 108  | 68    | 54    | 42,94 | 1 |

## 3/4" impact extension bar

DIN 3121

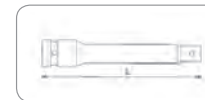

| Code   | L mm | €     |   |
|--------|------|-------|---|
| 198490 | 175  | 40,24 | 1 |
| 198492 | 325  | 51,21 | 1 |

## 3/4" impact universal joint

DIN 3121

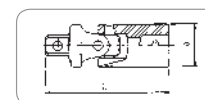

| Code   | L mm | €     |   |
|--------|------|-------|---|
| 198495 | 132  | 65,36 | 1 |

## 3/4" impact coupler

DIN 3121



| Code   | Female | Male | L mm | €     |   |
|--------|--------|------|------|-------|---|
| 198497 | 1"     | 3/4" | 65   | 26,24 | 1 |



## 1 - 1/2" sq. dr. impact socket

DIN 3129

Cr-Mo STEEL



| Code          | mm | L mm | Ø mm | €             |   |
|---------------|----|------|------|---------------|---|
| <b>198946</b> | 46 | 84   | 86   | <b>117,80</b> | 1 |
| <b>198950</b> | 50 | 87   | 86   | <b>117,80</b> | 1 |
| <b>198955</b> | 55 | 90   | 86   | <b>119,40</b> | 1 |
| <b>198960</b> | 60 | 92   | 94   | <b>133,85</b> | 1 |
| <b>198965</b> | 65 | 95   | 97   | <b>141,27</b> | 1 |
| <b>198970</b> | 70 | 100  | 105  | <b>164,10</b> | 1 |

| Code          | mm  | L mm | Ø mm | €             |   |
|---------------|-----|------|------|---------------|---|
| <b>198975</b> | 75  | 103  | 110  | <b>172,10</b> | 1 |
| <b>198980</b> | 80  | 110  | 116  | <b>180,10</b> | 1 |
| <b>198981</b> | 85  | 118  | 125  | <b>186,20</b> | 1 |
| <b>198982</b> | 90  | 118  | 130  | <b>192,10</b> | 1 |
| <b>198983</b> | 95  | 118  | 137  | <b>192,10</b> | 1 |
| <b>198984</b> | 100 | 125  | 144  | <b>210,20</b> | 1 |

## Safety ring for impact sockets

DIN 3129

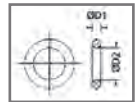

| Code          | ■    | Use                 | D1 mm | D2 mm | €           |   |
|---------------|------|---------------------|-------|-------|-------------|---|
|               |      | Accessories Sockets |       |       |             |   |
| <b>198276</b> | 1/2" | √ ≤ 14              | 4     | 19    | <b>2,02</b> | 5 |
| <b>198277</b> | 1/2" | ≥ 14                | 4     | 24    | <b>2,02</b> | 5 |
| <b>198396</b> | 3/4" | √ ≤ 50              | 5     | 36    | <b>2,02</b> | 5 |
| <b>198397</b> | 3/4" | ≥ 55                | 5     | 46    | <b>2,02</b> | 5 |
| <b>198498</b> | 1"   | √ ≤ 70              | 7     | 45    | <b>2,02</b> | 5 |

## Safety pin for impact sockets

DIN 3129

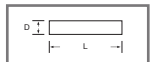

| Code          | ■    | Use                 | L mm | D mm | €           |   |
|---------------|------|---------------------|------|------|-------------|---|
|               |      | Accessories Sockets |      |      |             |   |
| <b>198278</b> | 1/2" | √ ≤ 14              | 20   | 3    | <b>1,39</b> | 5 |
| <b>198279</b> | 1/2" | ≥ 14                | 25   | 3    | <b>1,47</b> | 5 |
| <b>198398</b> | 3/4" | √ ≤ 50              | 35   | 4    | <b>1,52</b> | 5 |
| <b>198399</b> | 3/4" | ≥ 55                | 45   | 4    | <b>1,63</b> | 5 |
| <b>198499</b> | 1"   | √ ≤ 70              | 45   | 6    | <b>1,77</b> | 5 |



## 08 Striking tools

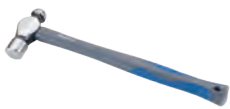

Industrial hammer 157



Stonning hammer 158



Sledge hammer 159



Construction hammer 159



Axe 160



Mason's hammer 161



Nylon head hammer 162



Anti spark hammer 162



Dead blow hammer 163



Punch 164



Mason's chisel 166



Flat chisel 168

**Ball pein hammer, graphite handle**

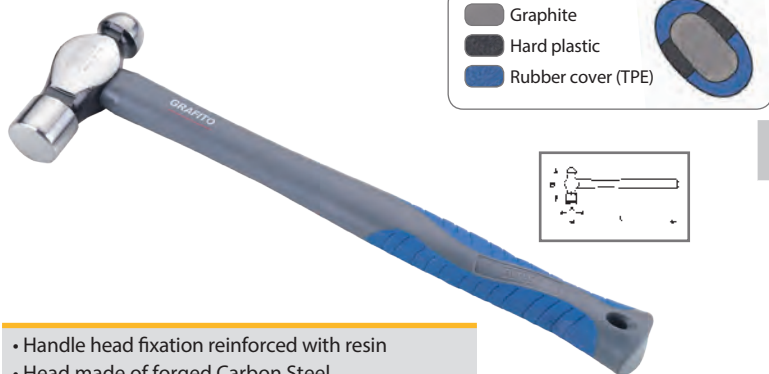

- Graphite
- Hard plastic
- Rubber cover (TPE)

- Handle head fixation reinforced with resin
- Head made of forged Carbon Steel
- Striking surface heat treated (harder)
- Ergonomic graphite handle
- With hole to hang

**Graphite-glass fibre comparison**

- **LIGHTER.** Approximately 20% less weight.
- **STRONGER.** Resistance to impacts 30% greater.
- **ANTI-VIBRATION.** Absorbs the vibration of the impact more effectively, and transmits less to the arm. More ergonomic.

| Code          | gr   | A mm | L mm | €            |   |
|---------------|------|------|------|--------------|---|
| <b>196652</b> | 455  | 30   | 355  | <b>15,42</b> | 6 |
| <b>196654</b> | 560  | 32   | 380  | <b>16,83</b> | 6 |
| <b>196657</b> | 680  | 34   | 405  | <b>18,37</b> | 6 |
| <b>196663</b> | 910  | 38   | 405  | <b>21,56</b> | 6 |
| <b>196664</b> | 1360 | 40   | 405  | <b>32,35</b> | 6 |

**SPARE HANDLE**

|               |                            |             |   |
|---------------|----------------------------|-------------|---|
| <b>196653</b> | for 196652, 196654         | <b>7,97</b> | 6 |
| <b>196658</b> | for 196657, 196663, 196664 | <b>8,63</b> | 6 |

**Ball pein hammer, hickory handle**



- Hickory handle
- Handle fixed to head with metal wedge and epoxy resin

| Code          | gr   | A mm | L mm | €            |   |
|---------------|------|------|------|--------------|---|
| <b>196548</b> | 360  | 28   | 345  | <b>9,51</b>  | 6 |
| <b>196550</b> | 455  | 30   | 355  | <b>11,58</b> | 6 |
| <b>196554</b> | 520  | 32   | 380  | <b>12,66</b> | 6 |
| <b>196555</b> | 680  | 34   | 405  | <b>13,84</b> | 6 |
| <b>196560</b> | 910  | 38   | 405  | <b>17,33</b> | 6 |
| <b>196562</b> | 1360 | 40   | 405  | <b>20,37</b> | 6 |

**SPARE HANDLE**

|               |                            |             |   |
|---------------|----------------------------|-------------|---|
| <b>196551</b> | for 196548, 196550, 196554 | <b>4,48</b> | 6 |
| <b>196556</b> | for 196555, 196560         | <b>4,70</b> | 6 |
| <b>196563</b> | for 196562                 | <b>5,02</b> | 6 |

**French joiner's hammer, graphite handle**



- Handle head fixation reinforced with resin

| Code          | gr  | A mm | L mm | €            |   |
|---------------|-----|------|------|--------------|---|
| <b>196612</b> | 80  | 16   | 310  | <b>12,58</b> | 6 |
| <b>196617</b> | 135 | 20   | 310  | <b>13,46</b> | 6 |
| <b>196622</b> | 180 | 22   | 310  | <b>14,43</b> | 6 |
| <b>196628</b> | 320 | 25   | 310  | <b>15,51</b> | 6 |
| <b>196632</b> | 420 | 30   | 310  | <b>15,95</b> | 6 |

**SPARE HANDLE**

|               |                    |             |   |
|---------------|--------------------|-------------|---|
| <b>196613</b> | for 196612, 196617 | <b>5,57</b> | 6 |
| <b>196629</b> | for 196622, 196628 | <b>6,12</b> | 6 |
| <b>196634</b> | for 196632         | <b>6,61</b> | 6 |

**French joiner's hammer, hickory handle**



| Code          | gr  | A mm | L mm | €           |   |
|---------------|-----|------|------|-------------|---|
| <b>196510</b> | 100 | 18   | 280  | <b>6,89</b> | 6 |
| <b>196515</b> | 135 | 20   | 280  | <b>7,12</b> | 6 |
| <b>196520</b> | 180 | 22   | 280  | <b>7,75</b> | 6 |
| <b>196523</b> | 320 | 25   | 280  | <b>8,03</b> | 6 |
| <b>196524</b> | 420 | 30   | 280  | <b>9,57</b> | 6 |

**SPARE HANDLE**

|               |                            |             |   |
|---------------|----------------------------|-------------|---|
| <b>196511</b> | for 196510, 196515, 196520 | <b>3,17</b> | 6 |
| <b>196522</b> | for 196523                 | <b>3,39</b> | 6 |
| <b>196527</b> | for 196524                 | <b>3,71</b> | 6 |

## Club hammer, graphite handle



- Head made of forged Carbon Steel
- Striking surface heat treated (harder)
- Conic adjustment of the head

| Code          | Weight Kg          | L mm | €            |   |
|---------------|--------------------|------|--------------|---|
| <b>196605</b> | 1                  | 290  | <b>17,32</b> | 4 |
| <b>196608</b> | 1,4                | 290  | <b>22,36</b> | 4 |
| SPARE HANDLE  |                    |      |              |   |
| <b>196606</b> | for 196605, 196608 |      | <b>8,03</b>  | 6 |

## Club hammer, wooden handle



- Head made of forged Carbon Steel
- Striking surface heat treated (harder)
- Conic adjustment of the head

| Code          | Weight Kg          | L mm | €            |   |
|---------------|--------------------|------|--------------|---|
| <b>196500</b> | 1                  | 260  | <b>10,97</b> | 6 |
| <b>196502</b> | 1,4                | 260  | <b>12,07</b> | 4 |
| SPARE HANDLE  |                    |      |              |   |
| <b>196501</b> | for 196500, 196502 |      | <b>2,50</b>  | 6 |

## Club hammer, fibreglass handle



## Club hammer, wooden handle



| Code          | Weight Kg  | L mm | €            |   |
|---------------|------------|------|--------------|---|
| <b>196619</b> | 2          | 280  | <b>17,60</b> | 4 |
| SPARE HANDLE  |            |      |              |   |
| <b>196618</b> | for 196619 |      | <b>3,71</b>  | 6 |

| Code          | Weight Kg  | L mm | €            |   |
|---------------|------------|------|--------------|---|
| <b>196519</b> | 2          | 280  | <b>14,52</b> | 4 |
| SPARE HANDLE  |            |      |              |   |
| <b>196518</b> | for 196519 |      | <b>2,50</b>  | 6 |

## Construction hammer, fibreglass handle



## Construction hammer, wooden handle



- Conic joint

- Conic joint

| Code          | Weight Kg  | L mm | €            |   |
|---------------|------------|------|--------------|---|
| <b>196603</b> | 1          | 250  | <b>14,63</b> | 6 |
| SPARE HANDLE  |            |      |              |   |
| <b>196604</b> | for 196603 |      | <b>3,71</b>  | 6 |

| Code          | Weight Kg  | L mm | €            |   |
|---------------|------------|------|--------------|---|
| <b>196503</b> | 1          | 250  | <b>12,70</b> | 6 |
| SPARE HANDLE  |            |      |              |   |
| <b>196504</b> | for 196503 |      | <b>18,33</b> | 6 |

**Sledge hammer, fiberglass handle**



| Code          | kg                     | L mm | €            |   |
|---------------|------------------------|------|--------------|---|
| <b>196625</b> | 3                      | 900  | <b>39,45</b> | 4 |
| <b>196627</b> | 4                      | 900  | <b>43,79</b> | 2 |
| <b>196630</b> | 5                      | 900  | <b>48,19</b> | 2 |
| SPARE HANDLE  |                        |      |              |   |
| <b>196631</b> | 196625, 196627, 196630 |      | <b>14,21</b> | 6 |

**Sledge hammer, wooden handle**



| Code          | kg                 | L mm | €            |   |
|---------------|--------------------|------|--------------|---|
| <b>196525</b> | 3                  | 900  | <b>26,61</b> | 4 |
| <b>196530</b> | 5                  | 900  | <b>34,85</b> | 2 |
| SPARE HANDLE  |                    |      |              |   |
| <b>196531</b> | for 196525, 196530 |      | <b>8,18</b>  | 6 |

**Claw hammer, fiberglass handle**



| Code          | gr                 | L mm | €            |   |
|---------------|--------------------|------|--------------|---|
| <b>196665</b> | 400                | 330  | <b>11,79</b> | 6 |
| <b>196670</b> | 600                | 330  | <b>13,14</b> | 6 |
| <b>196675</b> | 800                | 390  | <b>14,55</b> | 6 |
| SPARE HANDLE  |                    |      |              |   |
| <b>196666</b> | for 196665, 196670 |      | <b>4,80</b>  | 6 |
| <b>196676</b> | for 196675         |      | <b>5,35</b>  | 6 |

**Claw hammer, wooden handle**



| Code          | gr                 | L mm | €            |   |
|---------------|--------------------|------|--------------|---|
| <b>196565</b> | 400                | 330  | <b>9,72</b>  | 6 |
| <b>196570</b> | 600                | 330  | <b>10,99</b> | 6 |
| <b>196575</b> | 800                | 390  | <b>12,47</b> | 6 |
| SPARE HANDLE  |                    |      |              |   |
| <b>196566</b> | for 196565, 196570 |      | <b>2,50</b>  | 6 |
| <b>196576</b> | for 196575         |      | <b>3,16</b>  | 6 |

**Construction hammer, fiberglass handle**



500 gr. hammer (196680)



| • Oval joint • Magnetic head |                    |      |              |   |
|------------------------------|--------------------|------|--------------|---|
| Code                         | gr                 | L mm | €            |   |
| <b>196680</b>                | 500                | 500  | <b>18,33</b> | 6 |
| <b>196690</b>                | 700                | 500  | <b>22,29</b> | 6 |
| SPARE HANDLE                 |                    |      |              |   |
| <b>196681</b>                | for 196680, 196690 |      | <b>10,28</b> | 6 |

**Construction hammer, wooden handle**



500 gr. hammer (196580)

| • Oval joint • Magnetic head |                    |      |              |   |
|------------------------------|--------------------|------|--------------|---|
| Code                         | gr                 | L mm | €            |   |
| <b>196580</b>                | 500                | 500  | <b>13,28</b> | 6 |
| <b>196590</b>                | 700                | 500  | <b>14,02</b> | 6 |
| SPARE HANDLE                 |                    |      |              |   |
| <b>196581</b>                | for 196580, 196590 |      | <b>2,63</b>  | 6 |

## Axe, fiberglass handle



- Regrindable cutting edge. Polished finish.
- Conic adjustment

| Code          | Weight gr          | L mm | €            |   |
|---------------|--------------------|------|--------------|---|
| <b>198720</b> | 500                | 450  | <b>21,01</b> | 6 |
| <b>198725</b> | 700                | 450  | <b>22,84</b> | 6 |
| <b>198730</b> | 1000               | 680  | <b>28,83</b> | 4 |
| <b>198732</b> | 1200               | 680  | <b>32,65</b> | 4 |
| SPARE HANDLE  |                    |      |              |   |
| <b>198726</b> | for 198720, 198725 |      | <b>8,30</b>  | 6 |
| <b>198733</b> | for 198730, 198732 |      | <b>9,17</b>  | 6 |

## Axe, wooden handle



- Regrindable cutting edge. Polished finish.
- Conic adjustment

| Code          | Weight gr          | L mm | €            |   |
|---------------|--------------------|------|--------------|---|
| <b>198620</b> | 500                | 450  | <b>17,77</b> | 6 |
| <b>198625</b> | 700                | 450  | <b>19,23</b> | 6 |
| <b>198630</b> | 1000               | 680  | <b>26,18</b> | 4 |
| <b>198632</b> | 1200               | 680  | <b>28,50</b> | 4 |
| SPARE HANDLE  |                    |      |              |   |
| <b>198626</b> | for 198620, 198625 |      | <b>7,86</b>  | 6 |
| <b>198633</b> | for 198630, 198632 |      | <b>9,06</b>  | 6 |

## Pick Axe



- Cr-V steel. Forged body
- Polished tips. Oval handle housing

| Code          | Weight Kg | €            |   |
|---------------|-----------|--------------|---|
| <b>198670</b> | 2,5       | <b>18,42</b> | 6 |
| <b>198675</b> | 3         | <b>19,78</b> | 6 |

## Pick handle



- Ergonomic handles
- Conic adjustment to head

| Code          | Type   | Ø x L mm | €            |   |
|---------------|--------|----------|--------------|---|
| <b>198676</b> | Wooden | 38 x 900 | <b>9,61</b>  | 6 |
| <b>198776</b> | Fibre  | 38 x 900 | <b>19,07</b> | 6 |

## Felling axe, fiberglass handle



- Regrindable cutting edge. Polished finish.
- Conic adjustment

| Code          | Weight kg  | L mm | €            |   |
|---------------|------------|------|--------------|---|
| <b>196633</b> | 3          | 900  | <b>57,71</b> | 1 |
| SPARE HANDLE  |            |      |              |   |
| <b>196631</b> | for 196633 |      | <b>14,21</b> | 6 |

## Welder's hammer



### SPECIAL WELDERS

- Metal tubular handle
- Ergonomic rubber grip

| Code          | Weight gr | L mm | €           |   |
|---------------|-----------|------|-------------|---|
| <b>198748</b> | 400       | 300  | <b>8,60</b> | 6 |

**Mason's hammer, fiberglass handle**



| Code                | Weight gr  | L mm | €            |   |
|---------------------|------------|------|--------------|---|
| <b>196695</b>       | 700        | 370  | <b>21,08</b> | 6 |
| <b>SPARE HANDLE</b> |            |      |              |   |
| <b>196666</b>       | for 196695 |      | <b>4,80</b>  | 6 |

**Mason's hammer, wooden handle**



| Code                | Weight gr  | L mm | €            |   |
|---------------------|------------|------|--------------|---|
| <b>196595</b>       | 700        | 330  | <b>16,50</b> | 6 |
| <b>SPARE HANDLE</b> |            |      |              |   |
| <b>196566</b>       | for 196595 |      | <b>2,50</b>  | 6 |

**Pick-axe, fiberglass handle**



| Code                | Weight gr          | L mm | €            |   |
|---------------------|--------------------|------|--------------|---|
| <b>198750</b>       | 550                | 370  | <b>18,59</b> | 6 |
| <b>198755</b>       | 650                | 370  | <b>19,49</b> | 6 |
| <b>SPARE HANDLE</b> |                    |      |              |   |
| <b>196666</b>       | for 198750, 198755 |      | <b>4,80</b>  | 6 |

**Pick-axe, wooden handle**



| Code                | Weight gr          | L mm | €            |   |
|---------------------|--------------------|------|--------------|---|
| <b>198650</b>       | 550                | 330  | <b>14,05</b> | 6 |
| <b>198655</b>       | 650                | 330  | <b>14,95</b> | 6 |
| <b>SPARE HANDLE</b> |                    |      |              |   |
| <b>196566</b>       | for 198650, 198655 |      | <b>2,50</b>  | 6 |

**Pick-Axe, fiberglass handle**



| Code                | Weight gr          | L mm | €            |   |
|---------------------|--------------------|------|--------------|---|
| <b>198758</b>       | 400                | 370  | <b>16,83</b> | 6 |
| <b>198760</b>       | 650                | 370  | <b>17,57</b> | 6 |
| <b>SPARE HANDLE</b> |                    |      |              |   |
| <b>196666</b>       | for 198758, 198760 |      | <b>4,80</b>  | 6 |

**Pick-Axe, wooden handle**



| Code                | Weight gr          | L mm | €            |   |
|---------------------|--------------------|------|--------------|---|
| <b>198658</b>       | 400                | 330  | <b>12,67</b> | 6 |
| <b>198660</b>       | 650                | 330  | <b>13,45</b> | 6 |
| <b>SPARE HANDLE</b> |                    |      |              |   |
| <b>196566</b>       | for 198658, 198660 |      | <b>2,50</b>  | 6 |

## Nylon head hammer

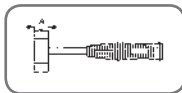

- Body made of iron and black finish
- Pressure-inserted heads in metal body
- Handle ergonomically shaped at gripping area

| Code          | A<br>Ø mm | Weight<br>gr | €            |   |
|---------------|-----------|--------------|--------------|---|
| <b>196805</b> | 28        | 300          | <b>16,45</b> | 6 |
| <b>196810</b> | 34        | 600          | <b>20,58</b> | 6 |
| <b>196815</b> | 44        | 1100         | <b>28,33</b> | 6 |

## Nylon head hammer, wooden handle

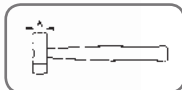

- Wooden handle securely locked in hammer body with metal pin
- High-quality varnished wooden handle

| Code          | A<br>Ø mm | Weight<br>gr | €            |   |
|---------------|-----------|--------------|--------------|---|
| <b>196705</b> | 28        | 300          | <b>11,40</b> | 6 |
| <b>196710</b> | 34        | 550          | <b>13,68</b> | 6 |
| <b>196715</b> | 44        | 1050         | <b>20,58</b> | 6 |
| <b>196720</b> | 54        | 1100         | <b>37,99</b> | 6 |

## Spare nylon head



### FITTING INSTRUCTIONS:

The nylon heads are fitted by inserting them in the hammer body and using force to tap them fully into their housing.

| Code          | Ø mm | €           |    |
|---------------|------|-------------|----|
| <b>196701</b> | 28   | <b>2,07</b> | 10 |
| <b>196702</b> | 34   | <b>2,49</b> | 10 |
| <b>196703</b> | 44   | <b>3,32</b> | 10 |
| <b>196704</b> | 54   | <b>6,00</b> | 10 |

## Dead blow nylon head hammer



- Iron body, Zinc coated
- Treated replaceable nylon heads

| Code          | A<br>Ø mm  | Weight<br>gr | €            |    |
|---------------|------------|--------------|--------------|----|
| <b>196725</b> | 35         | 500          | <b>23,06</b> | 6  |
| <b>196730</b> | 50         | 1100         | <b>36,05</b> | 6  |
| SPARE HEADS   |            |              |              |    |
| <b>196727</b> | for 196725 |              | <b>2,58</b>  | 10 |
| <b>196732</b> | for 196730 |              | <b>3,79</b>  | 10 |

## Anti spark copper sledge



- Head in copper alloy (antispark).
- High quality varnished wooden handle.
- Handle fixed with conic adjustment

| Code          | Weight<br>gr | Measure<br>mm | €             |   |
|---------------|--------------|---------------|---------------|---|
| <b>196760</b> | 500          | 25x80x300     | <b>49,05</b>  | 1 |
| <b>196762</b> | 1000         | 32x100x300    | <b>72,98</b>  | 1 |
| <b>196764</b> | 1500         | 38x120x360    | <b>94,57</b>  | 1 |
| <b>196766</b> | 2000         | 40x135x400    | <b>117,48</b> | 1 |
| <b>196768</b> | 4000         | 64x140x900    | <b>234,74</b> | 1 |

Used in iron and steel industry, mining, petrochemical industry and places with risk of deflagration

**Black rubber mallet, fiberglass handle**



| Code          | Weight gr | L mm | €           |   |
|---------------|-----------|------|-------------|---|
| <b>196781</b> | 455       | 340  | <b>7,75</b> | 6 |
| <b>196784</b> | 685       | 360  | <b>9,24</b> | 6 |

**White rubber mallet, fiberglass handle**



| Code          | Weight gr | L mm | €            |   |
|---------------|-----------|------|--------------|---|
| <b>196787</b> | 455       | 340  | <b>10,45</b> | 6 |

**Black rubber mallet, wooden handle**



• Hard rubber head.

| Code          | Weight gr | L mm | €           |   |
|---------------|-----------|------|-------------|---|
| <b>196780</b> | 455       | 310  | <b>6,43</b> | 6 |
| <b>196782</b> | 685       | 336  | <b>7,92</b> | 6 |
| <b>196783</b> | 910       | 360  | <b>9,49</b> | 6 |



• Does not leave a mark after striking.

| Code          | Weight gr | L mm | €            |   |
|---------------|-----------|------|--------------|---|
| <b>196785</b> | 455       | 310  | <b>9,03</b>  | 6 |
| <b>196786</b> | 685       | 350  | <b>11,13</b> | 6 |

**Black and white rubber mallet**



| Code          | Weight gr | L mm | €            |   |
|---------------|-----------|------|--------------|---|
| <b>196788</b> | 685       | 350  | <b>10,35</b> | 6 |

**Dead blow hammer. Monobloc**



• Polyurethane encapsulated steel body  
• Monobloc shape.

| Code          | Weight gr | A Ø mm | L mm | €            |   |
|---------------|-----------|--------|------|--------------|---|
| <b>196789</b> | 455       | 42     | 300  | <b>13,15</b> | 6 |
| <b>196790</b> | 690       | 50     | 325  | <b>17,33</b> | 6 |
| <b>196792</b> | 920       | 56,5   | 337  | <b>19,48</b> | 6 |

## Pin punch with hand guard

**CR-V STEEL**

Striking point hardness 40 HRC

Ergonomically shaped Non-slip rubber handgrip

Hand protecting guard and inner body made of hard plastic

Areas where pressure is exercised are rough to prevent slipping during work

Black finish

Work surface 55 HRC

| Code          | D1 mm | D2 mm | L mm | €           |   |
|---------------|-------|-------|------|-------------|---|
| <b>140062</b> | 2     | 10    | 165  | <b>7,34</b> | 6 |
| <b>140063</b> | 3     | 10    | 175  | <b>7,34</b> | 6 |
| <b>140064</b> | 4     | 10    | 185  | <b>7,80</b> | 6 |
| <b>140065</b> | 5     | 10    | 200  | <b>7,80</b> | 6 |
| <b>140066</b> | 6     | 10    | 200  | <b>7,80</b> | 6 |
| <b>140068</b> | 8     | 10    | 200  | <b>8,46</b> | 6 |

Display with hanger

## Center punch with hand guard

**CR-V STEEL**



| Code          | D1 mm | D2 mm | L mm | €           |   |
|---------------|-------|-------|------|-------------|---|
| <b>140054</b> | 4     | 10    | 175  | <b>5,69</b> | 6 |
| <b>140056</b> | 6     | 10    | 175  | <b>6,12</b> | 6 |

Display with hanger

## Pin punches with hand guard set



### CONTENTS

2, 3, 4, 5, 6, 8 mm

| Code          | No. of Items | €            |   |
|---------------|--------------|--------------|---|
| <b>140070</b> | 6            | <b>46,53</b> | 1 |

## Pin punch

**CR-V STEEL**

**REGULAR TYPE**



| Code          | D Ø mm | H mm | L mm | €           |    |
|---------------|--------|------|------|-------------|----|
| <b>140020</b> | 2      | 10   | 150  | <b>4,87</b> | 10 |
| <b>140021</b> | 3      | 10   | 150  | <b>4,87</b> | 10 |
| <b>140022</b> | 4      | 10   | 150  | <b>5,19</b> | 10 |
| <b>140023</b> | 5      | 10   | 150  | <b>5,19</b> | 10 |
| <b>140024</b> | 6      | 10   | 150  | <b>5,19</b> | 10 |
| <b>140025</b> | 7      | 12   | 150  | <b>5,59</b> | 10 |
| <b>140026</b> | 8      | 12   | 150  | <b>5,59</b> | 10 |

• Hexagonal body

## LONG TYPE





| Code          | D Ø mm | H mm | L mm | €           |    |
|---------------|--------|------|------|-------------|----|
| <b>140034</b> | 4      | 10   | 180  | <b>6,13</b> | 10 |
| <b>140036</b> | 6      | 10   | 180  | <b>6,13</b> | 10 |

**Drift punch**

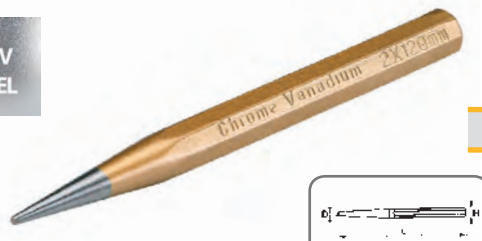
CR-V  
STEEL

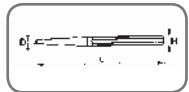

• Hexagonal body



| Code          | D<br>Ø mm | H<br>mm | L<br>mm | €           |    |
|---------------|-----------|---------|---------|-------------|----|
| <b>140012</b> | 2         | 10      | 120     | <b>3,71</b> | 10 |
| <b>140013</b> | 3         | 10      | 120     | <b>3,71</b> | 10 |
| <b>140014</b> | 4         | 10      | 120     | <b>3,78</b> | 10 |
| <b>140015</b> | 5         | 10      | 120     | <b>4,06</b> | 10 |
| <b>140016</b> | 6         | 10      | 120     | <b>4,06</b> | 10 |

**Center punch**

CR-V  
STEEL

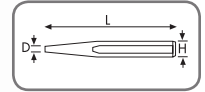

| Code          | D<br>Ø mm | H<br>mm | L<br>mm | €           |    |
|---------------|-----------|---------|---------|-------------|----|
| <b>138004</b> | 3         | 10      | 100     | <b>3,78</b> | 10 |
| <b>138005</b> | 4         | 10      | 120     | <b>4,05</b> | 10 |
| <b>138006</b> | 5         | 12      | 120     | <b>4,23</b> | 10 |
| <b>138007</b> | 6         | 12      | 120     | <b>4,66</b> | 10 |
| <b>138008</b> | 8         | 12      | 120     | <b>4,79</b> | 10 |

**Automatic punch**



- Body made of steel
- Tip made of HSS steel
- Plastic head
- Adjustable power

| Code          | L<br>mm | €            |   |
|---------------|---------|--------------|---|
| <b>138021</b> | 135     | <b>10,81</b> | 6 |

Display with blister

**Pin punch set in metal case**



**CONTENTS**  
2, 3, 4, 5, 6, 8 mm

| Code          | No.<br>of Items | €            |   |
|---------------|-----------------|--------------|---|
| <b>140029</b> | 6               | <b>30,83</b> | 1 |

**Drift and center punch set in metal case**



**CONTENTS**  
• 5 Drift punches of 2, 3, 4, 5, 6 mm • 1 Center punch of 4 mm

| Code          | No.<br>of Items | €            |   |
|---------------|-----------------|--------------|---|
| <b>140019</b> | 6               | <b>23,40</b> | 1 |

**Combined Punch + Chisel set in metal case**



**CONTENTS**  
• 1 Chisel 12x10x150 mm  
• 1 Center punch of 5 mm  
• 2 Drift punches of 3 and 4 mm  
• 1 Cross chisel 4x10x130  
• 1 Pin punch 5 mm

| Code          | No.<br>of Items | €            |   |
|---------------|-----------------|--------------|---|
| <b>140050</b> | 6               | <b>34,50</b> | 1 |

## Mason's chisels with hand guard

Cr-Si-Mo  
STEEL

Ergonomic shaped grip area

Wing area in high resistance plastic material

Hardened striking area of 40 HRC

Octagonal shaped body

Hand grip area in anti-slip rubber. Grooved area for better grip.

- Hardness on work surface 55 HRC  
- Polished and resharpenable point



| Code          | L mm | B x A mm | €            |   |
|---------------|------|----------|--------------|---|
| <b>196956</b> | 250  | 16x23    | <b>8,52</b>  | 6 |
| <b>196961</b> | 300  | 16x23    | <b>8,95</b>  | 6 |
| <b>196966</b> | 350  | 18x26    | <b>10,46</b> | 6 |
| <b>196971</b> | 400  | 18x26    | <b>11,08</b> | 6 |

## Point chisel with hand guard

Cr-Si-Mo  
STEEL

Polished and resharpenable point

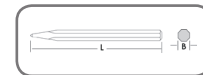

| Code          | L mm | B x A mm | €            |   |
|---------------|------|----------|--------------|---|
| <b>196911</b> | 250  | 16x23    | <b>8,06</b>  | 6 |
| <b>196916</b> | 300  | 16x23    | <b>8,73</b>  | 6 |
| <b>196921</b> | 350  | 18x26    | <b>9,94</b>  | 6 |
| <b>196926</b> | 400  | 18x26    | <b>10,61</b> | 6 |

## Bimaterial hand guard



- 196975 for chisels of diameter 16 mm
- 196977 for chisels of diameter 18 mm

| Code          | L mm | Ø exterior | €           |   |
|---------------|------|------------|-------------|---|
| <b>196975</b> | 150  | 26         | <b>4,62</b> | 6 |
| <b>196977</b> | 150  | 32         | <b>4,62</b> | 6 |

## Heavy duty Mason's chisel

Cr-Si-Mo  
STEEL

Polished and resharpenable point

## Heavy duty octagonal body



| Code          | L mm | BxA mm | €            |   |
|---------------|------|--------|--------------|---|
| <b>196952</b> | 200  | 18x20  | <b>7,27</b>  | 6 |
| <b>196957</b> | 250  | 20x23  | <b>10,45</b> | 6 |
| <b>196962</b> | 300  | 20x23  | <b>12,78</b> | 6 |

Display with hanger

**Mason's chisel**

Cr-Si-Mo  
STEEL

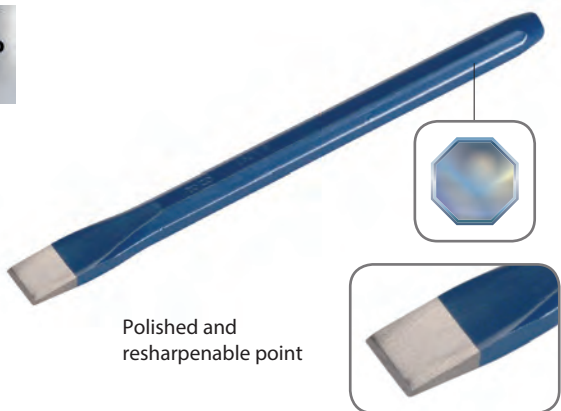

Polished and  
resharpenable point



- Octogonal shaped body
- Hardness on work surface 55 HRC

| Code          | L mm | B x A mm | €           |  |
|---------------|------|----------|-------------|---|
| <b>196950</b> | 200  | 16x23    | <b>5,58</b> | 6   |
| <b>196955</b> | 250  | 16x23    | <b>6,10</b> | 6   |
| <b>196960</b> | 300  | 16x23    | <b>6,51</b> | 6   |
| <b>196965</b> | 350  | 18x26    | <b>8,50</b> | 6   |
| <b>196970</b> | 400  | 18x26    | <b>8,98</b> | 6   |

Display with hanger

**Point chisel**

Cr-Si-Mo  
STEEL



Polished and  
resharpenable point



- Octogonal shaped body
- Hardness on work surface 55 HRC

| Code          | L mm | B x A mm | €           |  |
|---------------|------|----------|-------------|---|
| <b>196905</b> | 200  | 14x20    | <b>5,23</b> | 6   |
| <b>196910</b> | 250  | 16x23    | <b>5,91</b> | 6   |
| <b>196915</b> | 300  | 16x23    | <b>6,53</b> | 6   |
| <b>196920</b> | 350  | 18x26    | <b>7,73</b> | 6   |
| <b>196925</b> | 400  | 18x26    | <b>8,42</b> | 6   |

Display with hanger

**Electrician's chisel**

Cr-Si-Mo  
STEEL

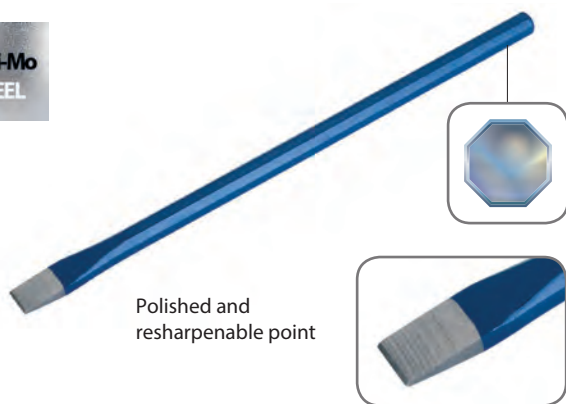

Polished and  
resharpenable point



- Octogonal shaped body
- Hardness on work surface 55 HRC

| Code          | L mm | B x A mm | €           |  |
|---------------|------|----------|-------------|---|
| <b>196930</b> | 200  | 10x12    | <b>4,56</b> | 6   |
| <b>196935</b> | 250  | 10x12    | <b>5,24</b> | 6   |
| <b>196940</b> | 300  | 10x12    | <b>5,89</b> | 6   |

**Mason's and point chisels displayer**



**CONTENTS**

|                               |                             |
|-------------------------------|-----------------------------|
| 6 200 x 14 mm mason's chisels | 6 200 x 14 mm point chisels |
| 6 250 x 16 mm mason's chisels | 6 250 x 16 mm point chisels |
| 6 300 x 16 mm mason's chisels | 6 300 x 16 mm point chisels |
| 6 350 x 18 mm mason's chisels | 6 350 x 18 mm point chisels |
| 6 400 x 18 mm mason's chisels | 6 400 x 18 mm point chisels |

| Code          | No. of Items | €             |  |
|---------------|--------------|---------------|---|
| <b>196979</b> | 60           | <b>418,38</b> | 1   |

## Flat chisel with hand guard

Cr-Si-Mo  
STEEL

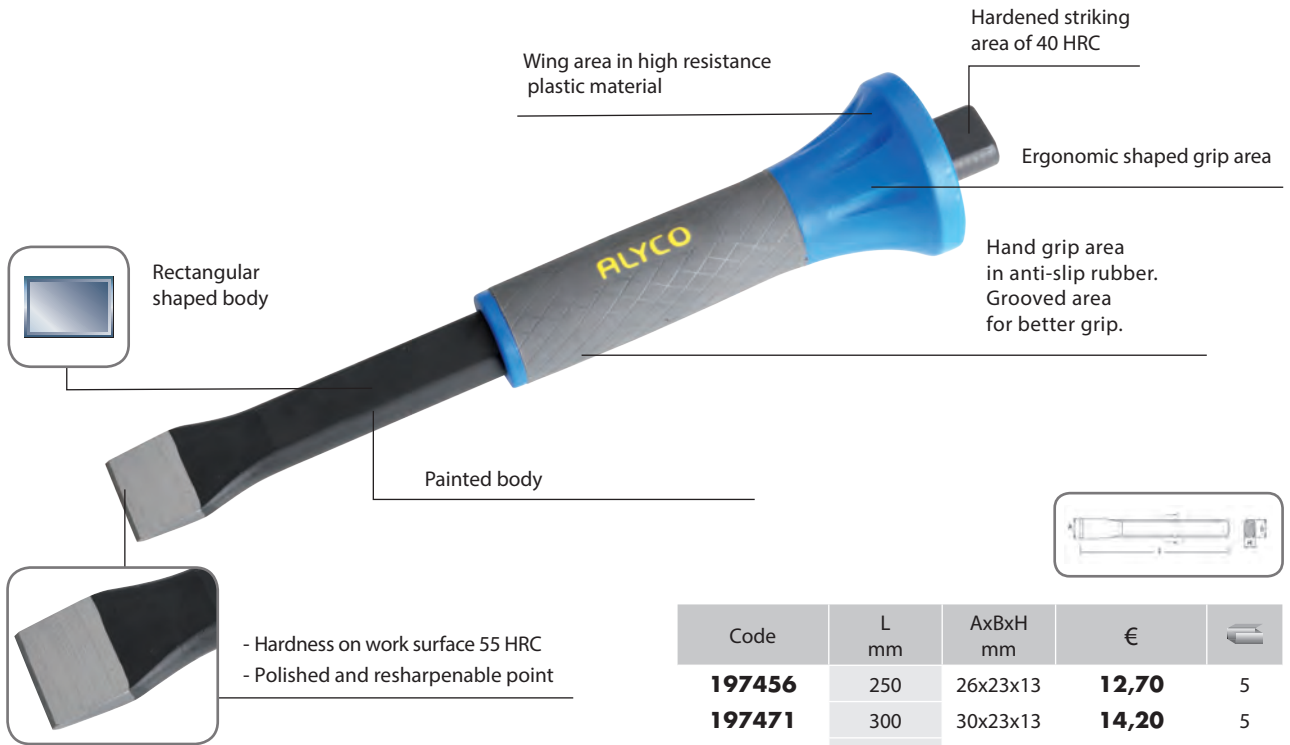

| Code          | L mm | AxBxH mm | €            |   |
|---------------|------|----------|--------------|---|
| <b>197456</b> | 250  | 26x23x13 | <b>12,70</b> | 5 |
| <b>197471</b> | 300  | 30x23x13 | <b>14,20</b> | 5 |
| <b>197473</b> | 350  | 30x23x13 | <b>14,70</b> | 5 |
| <b>197475</b> | 400  | 30x23x13 | <b>17,40</b> | 5 |

## Flat chisel

Cr-Si-Mo  
STEEL



| Code          | L mm | AxBxH mm | €            |   |
|---------------|------|----------|--------------|---|
| <b>197450</b> | 200  | 24x23x13 | <b>8,55</b>  | 6 |
| <b>197455</b> | 250  | 26x23x13 | <b>9,40</b>  | 6 |
| <b>197470</b> | 300  | 30x23x13 | <b>10,60</b> | 6 |
| <b>197472</b> | 350  | 30x23x13 | <b>11,20</b> | 6 |
| <b>197474</b> | 400  | 30x23x13 | <b>12,90</b> | 6 |

## Brick bolster

Cr-Si-Mo  
STEEL



- Resharpenable polished tips
- Painted presentation

| Code          | L mm | AxBxH mm | €            |   |
|---------------|------|----------|--------------|---|
| <b>197460</b> | 250  | 50x23x13 | <b>14,00</b> | 6 |
| <b>197465</b> | 250  | 70x23x13 | <b>16,50</b> | 6 |

## Brick bolster with hand guard



| Code          | L mm | AxBxH mm | €            |   |
|---------------|------|----------|--------------|---|
| <b>197461</b> | 250  | 50x23x13 | <b>17,30</b> | 6 |
| <b>197466</b> | 250  | 70x23x13 | <b>19,70</b> | 6 |

**Flat chisel**

Cr-Si-Mo  
STEEL



- Resharpenable polished tips
- Painted presentation



| Code          | L mm | BxH mm | €           |   |
|---------------|------|--------|-------------|---|
| <b>197480</b> | 240  | 25x7   | <b>9,50</b> | 6 |

**Flat chisel with hand guard**



| Code          | L mm | BxH mm | €            |   |
|---------------|------|--------|--------------|---|
| <b>197481</b> | 240  | 25x7   | <b>11,80</b> | 6 |

**Cross chisel**

Cr-Si-Mo  
STEEL



- Resharpenable polished tips
- Painted presentation



| Code          | L mm | BxH mm | €            |   |
|---------------|------|--------|--------------|---|
| <b>197001</b> | 200  | 23x13  | <b>9,90</b>  | 6 |
| <b>197003</b> | 250  | 23x13  | <b>11,50</b> | 6 |

**Cross chisel with hand guard**



| Code          | L mm | BxH mm | €            |   |
|---------------|------|--------|--------------|---|
| <b>197004</b> | 250  | 23x13  | <b>12,60</b> | 6 |

**Bimaterial hand guard**



For flat chisels, mason's chisels and cross chisels



196989

For flat chisels

| Code          | L mm | €           |   |
|---------------|------|-------------|---|
| <b>196994</b> | 150  | <b>3,53</b> | 6 |
| <b>196989</b> | 130  | <b>3,71</b> | 6 |

**Chisels and punches displayer**



**CONTENTS**

- 6 flat chisels of 200 mm
- 6 flat chisels of 300 mm
- 6 drift punches of 6 mm
- 6 pin punches of 3 mm
- 6 pin punches of 5 mm
- 6 center punches of 4 mm
- 6 flat chisels of 250 mm
- 6 drift punches of 3 mm
- 6 pin punches of 2 mm
- 6 pin punches of 4 mm
- 6 pin punches of 6 mm

| Code          | No. of Items | €             |   |
|---------------|--------------|---------------|---|
| <b>196995</b> | 66           | <b>450,20</b> | 1 |



## 09 Cutting and drilling



Hacksaw frame 171



Handsaw 172



Saw 173



Blade knife 174



Knife with snap-off blades 175



Wood chisel 177



File 178



Files set 181



Metal brush 182



Hand brush 185



Hole saw blade 186



Drill 188



Tap and die set 189



Masonry drill 190



Wood and plastic drill 192



Auger bit 193

**Heavy duty hacksaw**



Including hacksaw blade for wood and plastic of 6 tpi

**MAX TENSION OF THE BLADE: 2000 Kg /cm²**

- Hacksaw frame made of aluminium alloy
- Fastening and adjusting lever
- Handle covered in antislip material (rubber)
- Option of fastening the blade for 45° or 90° angle
- Housing for storing blades

| Code          | L mm | €            |   |
|---------------|------|--------------|---|
| <b>144093</b> | 400  | <b>19,77</b> | 6 |

**Aluminium hacksaw**



**BIMETALIC BLADE 300 MM LONG**

- Aluminium alloy body
- Fastening and adjusting the blade tension by wing nut
- Option of fastening the blade at 45° or 90°
- Option of setting with the blade projecting to use as a keyhole saw
- Hacksaw blade store

| Code          | L mm | €            |   |
|---------------|------|--------------|---|
| <b>144004</b> | 400  | <b>14,67</b> | 6 |

**Mini hacksaw**



INCLUDES:



Blade 24 Tpi

- Hacksaw frame made of Aluminium alloy material.
- With wheel for locking the blade.
- Hacksaw blade length can be adjusted.
- Blade made of Carbon Steel.

| Code          | L mm | €           |   |
|---------------|------|-------------|---|
| <b>144000</b> | 230  | <b>8,45</b> | 6 |

**Display with blister**

**Bimetal hacksaw blade**



**BIMETAL**

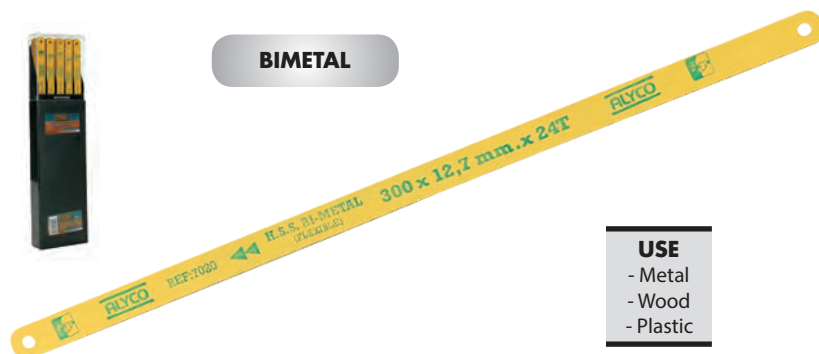

**USE**

- Metal
- Wood
- Plastic

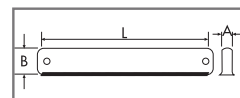

**300x13x0,65 mm**

- Frame manufactured in highly flexible steel alloy
- HSS edge welded to the steel alloy body
- Completely tempered between 63-67 HRC for great strength

| Code          | No of teeth | €           |     |
|---------------|-------------|-------------|-----|
| <b>197260</b> | 24          | <b>1,82</b> | 100 |

**Display in 100 units box**

## Junior hacksaw

BLADE 150 MM LONG

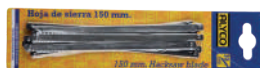

INCLUDES:



- Steel body
- Bimaterial handle in strong plastic ABS and anti-slip rubber TPR
- Bimetal hacksaw blade of Carbon 24 tpi

| Code          | L mm | €           |    |
|---------------|------|-------------|----|
| <b>144035</b> | 225  | <b>8,08</b> | 6  |
| SPARE BLADE   |      |             |    |
| <b>144036</b> |      | <b>0,56</b> | 10 |

Display in blister with 10 units

## Handsaw

STANDARD TEETH

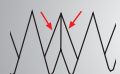

- Two cutting surfaces.
- Forward and reverse cut



| Code          | L " | L mm | €            |   |
|---------------|-----|------|--------------|---|
| <b>144055</b> | 16  | 400  | <b>10,26</b> | 6 |
| <b>144065</b> | 18  | 450  | <b>12,22</b> | 6 |
| <b>144075</b> | 22  | 550  | <b>15,72</b> | 6 |

## Backsaw

STANDARD TEETH

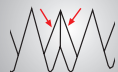

## Dovetail saw

STANDARD TEETH



| Code          | L " | L mm | €           |   |
|---------------|-----|------|-------------|---|
| <b>144086</b> | 10  | 250  | <b>7,27</b> | 6 |

## Backsaw for PVC

USE:

- Plastic
- Plasterboard
- Wooden coverings
- Wooden plywood



- Blade made of steel
- Induction hardened teeth
- Pointed blade for easy use in plaster
- Heavy duty bimaterial handle

| Code          | L " | L mm | €           |   |
|---------------|-----|------|-------------|---|
| <b>144087</b> | 10  | 250  | <b>9,39</b> | 6 |

**Handsaw + Mitre box pack**

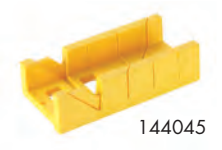

| Code          | €            |   |
|---------------|--------------|---|
| <b>144046</b> | <b>15,83</b> | 1 |

**Mitre plastic box**

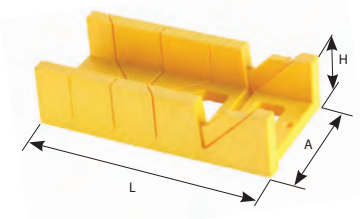

• Manufactured in ABS hard plastic

| Code          | L mm | A mm | H mm | €           |   |
|---------------|------|------|------|-------------|---|
| <b>144040</b> | 300  | 80   | 60   | <b>5,54</b> | 1 |
| <b>144045</b> | 300  | 140  | 60   | <b>7,49</b> | 1 |

**Saw blade**



**160 MM LONG BLADE**

| Code          | L " | L mm | €           |   |
|---------------|-----|------|-------------|---|
| <b>144098</b> | 12  | 300  | <b>9,46</b> | 6 |

**Compass saw**

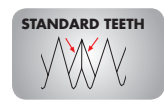

**325 MM LONG BLADE**

| Code          | L "  | L mm | €           |   |
|---------------|------|------|-------------|---|
| <b>144099</b> | 18,5 | 470  | <b>9,94</b> | 6 |

**Bowsaw**

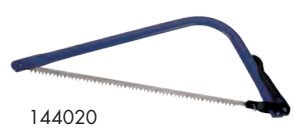

144020

| Code          | L blade " | L blade mm | €           |   |
|---------------|-----------|------------|-------------|---|
| <b>144020</b> | 21        | 525        | <b>6,12</b> | 6 |
| <b>144025</b> | 24        | 600        | <b>7,15</b> | 6 |
| <b>144030</b> | 30        | 750        | <b>7,53</b> | 6 |

**Bowsaw blade. Standard teeth**

**FOR DRY WOOD**



• Bowsaw blade made of Carbon steel



| Code          | L " | L mm | €           |    |
|---------------|-----|------|-------------|----|
| <b>144021</b> | 21  | 525  | <b>1,65</b> | 10 |
| <b>144026</b> | 24  | 600  | <b>1,92</b> | 10 |
| <b>144031</b> | 30  | 750  | <b>2,10</b> | 10 |

**Bowsaw blade. American teeth**

**FOR GREEN WOOD**



| Code          | L " | L mm | €           |    |
|---------------|-----|------|-------------|----|
| <b>144022</b> | 21  | 525  | <b>1,59</b> | 10 |
| <b>144027</b> | 24  | 600  | <b>1,86</b> | 10 |
| <b>144032</b> | 30  | 750  | <b>2,04</b> | 10 |

## Retractable blade knife with blades

SKS  
STEEL



Stainless steel body

Anodised aluminium handle

- Blades made of special SK5 steel in plastic protector pack
- Wheel for quick blade changes
- Ergonomic aluminium handle
- Metal clip for hanging

INCLUDES:



### SUITABLE BLADES:

195660 / 195675  
See page 176



Sliding frame



Metal clip for hanging

| Code          | L mm   |      | €            |   |
|---------------|--------|------|--------------|---|
|               | closed | open |              |   |
| <b>195606</b> | 110    | 150  | <b>14,13</b> | 6 |

Display with blister

## Foldable blade knife

SKS  
STEEL



INCLUDES:



- Blades made of special SK5 steel in plastic protector pack
- Wheel for quick blade changes
- Anodised aluminium handle
- Pusher for closing of the knife
- Stopper for an easier opening of the blade
- Metal clip for hanging

### SUITABLE BLADES:

195660 / 195665 / 195675  
See page 176

| Code          | L mm   |      | €            |   |
|---------------|--------|------|--------------|---|
|               | closed | open |              |   |
| <b>195607</b> | 110    | 160  | <b>11,74</b> | 6 |

Display with blister

## Foldable blade knife

SKS  
STEEL



INCLUDES:



- The same features of 195606 knife
- Chain suitable for hanging up

### SUITABLE BLADES:

195611  
See page 176

| Code          | L mm   |      | €            |   |
|---------------|--------|------|--------------|---|
|               | closed | open |              |   |
| <b>195608</b> | 70     | 100  | <b>10,65</b> | 5 |

Display with blister

**25 mm retractable segment blade knife**

SKS  
STEEL

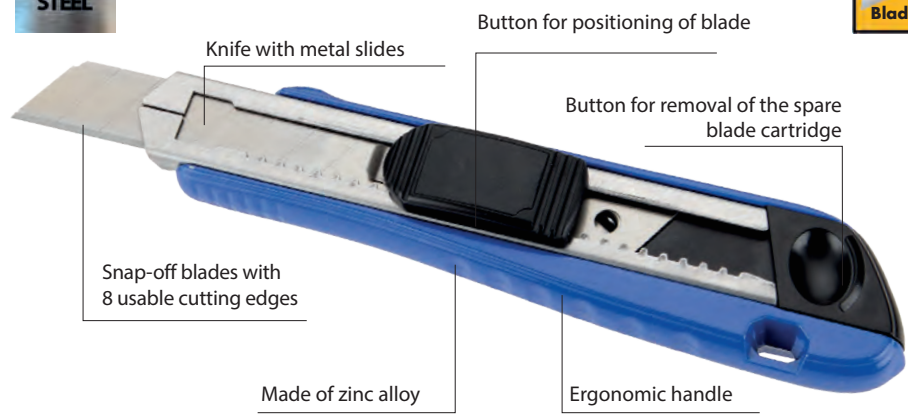

INCLUDES:  
**+ 5**  
Blades

**SUITABLE BLADES:**  
195685 / 195690  
See page 176



Secure fastening  
of the blade  
by screw

| Code          | L<br>mm | €           |    |
|---------------|---------|-------------|----|
| <b>195618</b> | 165     | <b>7,24</b> | 12 |

Display with blister

**18 mm segment blade knife**

SKS  
STEEL



INCLUDES:  
**+ 5**  
Blades

**SUITABLE BLADES:**  
195695  
See page 176

| Code          | L<br>mm | €           |   |
|---------------|---------|-------------|---|
| <b>195620</b> | 205     | <b>8,76</b> | 6 |

Display with blister

**9 mm segment blade knife**

SKS  
STEEL



INCLUDES:  
**+ 5**  
Blades

**SUITABLE BLADES:**  
195680  
See page 176

| Code          | L<br>mm | €           |    |
|---------------|---------|-------------|----|
| <b>195609</b> | 140     | <b>4,92</b> | 12 |

Display with blister

**18 mm segment knife with fixing screw**

SKS  
STEEL



**SUITABLE BLADES:**  
195685 / 195690  
See page 176

| Code          | L<br>mm | €           |    |
|---------------|---------|-------------|----|
| <b>195635</b> | 160     | <b>3,43</b> | 12 |

Display with blister

**18 mm knife and blade dispenser in pouch**



Loop to  
attach to a belt



**COMPOSITION**  
 • 18 mm knife (195618) with 5 spare blades  
 • 10 blade dispenser (195685)  
 • Nylon pouch (195641)

| Code          | No.<br>of items | €            |   |
|---------------|-----------------|--------------|---|
| <b>195640</b> | 3               | <b>10,40</b> | 6 |

Display with blister

## 18 mm security knife



Security button



### SUITABLE BLADES:

195685 / 195690  
See below

- Made of zinc alloy
- Ergonomic bimaterial handle
- With 18 mm segment blade
- Two positions:
  1. Automatic retraction of blade without press
  2. Press to take out blade



| Code          | L mm | €           |    |
|---------------|------|-------------|----|
| <b>195622</b> | 180  | <b>6,54</b> | 12 |

Display with blister

## Safety knife



### SUITABLE BLADES:

195660 / 195675 / 195665  
See below

- Aluminium body
- Automatic blade withdrawal when pressure is no longer applied.
- Supplied with blade.



| Code          | L mm | €           |    |
|---------------|------|-------------|----|
| <b>195610</b> | 165  | <b>7,50</b> | 12 |

Display in pouch

## Spare blade



**195660**  
10 blades



**195675**  
100 blades



**195665**  
5 blades



**195611**  
5 blades



**195680**  
**195685**  
**195695**  
10 blades



**195690**  
5 blades

| Type | Code          | Blades/Dispenser | €            |    | Type | Code          | mm | €            |    |
|------|---------------|------------------|--------------|----|------|---------------|----|--------------|----|
|      | <b>195660</b> | 10               | <b>2,59</b>  | 20 |      | <b>195680</b> | 9  | <b>2,34</b>  | 20 |
|      | <b>195675</b> | 100              | <b>25,43</b> | 1  |      | <b>195685</b> | 18 | <b>2,72</b>  | 12 |
|      | <b>195665</b> | 5                | <b>2,62</b>  | 12 |      | <b>195695</b> | 25 | <b>3,93</b>  | 10 |
|      | <b>195611</b> | 5                | <b>2,59</b>  | 12 |      | <b>195690</b> | 18 | <b>10,17</b> | 12 |

Price per blade pack

Price per blade pack

## 100 mm wide reinforced scraper

INCLUDES:

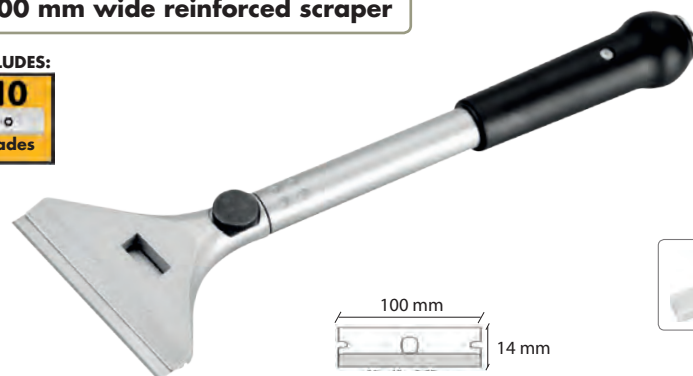

10 blade dispenser

- Handle covered with non-slip rubber
- Metallic reinforcement in the handle for striking
- Blade tightening roulette

| Code          | L mm | €            |   |
|---------------|------|--------------|---|
| <b>195580</b> | 300  | <b>10,54</b> | 6 |

Display with blister

| SPARE BLADES  |  |             |    |
|---------------|--|-------------|----|
| <b>195582</b> |  | <b>1,75</b> | 10 |

Display with blister of 10 units

**Wood chisel, bimaterial handle**

Cr-V  
STEEL



| Code   | A mm | €     |  |
|--------|------|-------|---|
| 125001 | 6    | 12,30 | 6   |
| 125002 | 8    | 12,31 | 6   |
| 125003 | 10   | 12,85 | 6   |
| 125004 | 12   | 12,91 | 6   |
| 125005 | 14   | 12,94 | 6   |
| 125035 | 16   | 13,18 | 6   |
| 125007 | 18   | 14,67 | 6   |
| 125008 | 20   | 15,04 | 6   |
| 125009 | 22   | 16,59 | 6   |
| 125010 | 25   | 18,26 | 6   |
| 125011 | 30   | 19,95 | 6   |
| 125036 | 32   | 20,90 | 6   |
| 125012 | 35   | 21,83 | 6   |
| 125037 | 38   | 22,00 | 6   |

Display with hanger

**Wood chise, wooden handle**

Cr-V  
STEEL



| Code   | A mm | €     |  |
|--------|------|-------|---|
| 125013 | 6    | 9,96  | 6   |
| 125014 | 8    | 10,00 | 6   |
| 125015 | 10   | 10,84 | 6   |
| 125016 | 12   | 11,06 | 6   |
| 125017 | 14   | 11,67 | 6   |
| 125038 | 16   | 11,97 | 6   |
| 125019 | 18   | 12,67 | 6   |
| 125020 | 20   | 12,91 | 6   |
| 125021 | 22   | 14,38 | 6   |
| 125022 | 25   | 15,35 | 6   |
| 125023 | 30   | 16,69 | 6   |
| 125039 | 32   | 17,32 | 6   |
| 125024 | 35   | 18,00 | 6   |
| 125040 | 38   | 18,48 | 6   |

Display with hanger

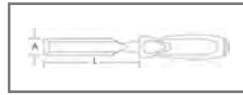

- Polished blade surface
- Metal reinforcement for striking
- Display with blade guard
- Handle with ergonomic shape

**Wood chisels with bimaterial handle set**



**CONTENTS** 3 chisels: 12, 20, 25 mm

| Code   | No. of items | €     |  |
|--------|--------------|-------|---|
| 125050 | 3            | 47,55 | 1   |

**Wood chisels displayer. Bimaterial handle**

**CONTENTS**

125002 (6), 125003 (6), 125004 (6), 125005 (6), 125035 (6), 125007 (6), 125008 (6), 125010 (6), 125011 (6), 125012 (6)

| Code   | No. of items | €      |  |
|--------|--------------|--------|---|
| 125601 | 60           | 923,74 | 1   |



**Wood chisels with wooden handle set**



**CONTENTS** 3 chisels: 12, 20, 25 mm

| Code   | No. of items | €     |  |
|--------|--------------|-------|---|
| 125060 | 3            | 40,51 | 1   |

**Wood chisels displayer. Wooden handle**

**CONTENTS**

125014 (6), 125015 (6), 125016 (6), 125017 (6), 125038 (6), 125019 (6), 125020 (6), 125022 (6), 125023 (6), 125024 (6)

| Code   | No. of items | €      |  |
|--------|--------------|--------|---|
| 125501 | 60           | 786,95 | 1   |

## Files

**CARBON STEEL**



Handle with ergonomic shape

Hole for hanging

Different blade shapes depending on the work to be carried out

Manufactured with high carbon content steels for high surface hardness in the working area.

Joint area between the blade and handle with reduced hardness (25-30 HRC) to prevent breakage

Tempered work area between 60-65 HRC

| Measurement mm | Bastard | Second cut |
|----------------|---------|------------|
| 100            | 14      | 20         |
| 150            | 11      | 16         |
| 200            | 10      | 14         |
| 250            | 9       | 12         |
| 300            | 8       | 11         |

No. of teeth per 10 mm

|  |                        |
|--|------------------------|
|  | <b>Flat file</b>       |
|  | <b>Half round file</b> |
|  | <b>Round file</b>      |
|  | <b>Square file</b>     |
|  | <b>Triangular file</b> |

## Flat file

**CARBON STEEL**

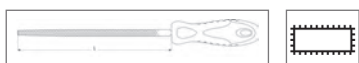
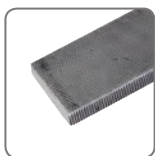

## Half round file

**CARBON STEEL**

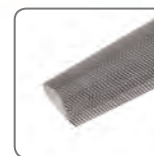

### SECOND CUT

| Code          | L " | L mm | No. of teeth | €            |   |
|---------------|-----|------|--------------|--------------|---|
| <b>197499</b> | 4   | 100  | 20           | <b>4,29</b>  | 6 |
| <b>197500</b> | 6   | 150  | 16           | <b>5,09</b>  | 6 |
| <b>197502</b> | 8   | 200  | 14           | <b>7,46</b>  | 6 |
| <b>197504</b> | 10  | 250  | 12           | <b>10,02</b> | 6 |
| <b>197505</b> | 12  | 300  | 11           | <b>12,65</b> | 6 |
| <b>197506</b> | 14  | 350  | 10           | <b>13,40</b> | 6 |

### BASTARD CUT

| Code          | L " | L mm | No. of teeth | €            |   |
|---------------|-----|------|--------------|--------------|---|
| <b>197702</b> | 8   | 200  | 10           | <b>6,95</b>  | 6 |
| <b>197704</b> | 10  | 250  | 9            | <b>9,33</b>  | 6 |
| <b>197705</b> | 12  | 300  | 8            | <b>11,77</b> | 6 |

Display with blister

### SECOND CUT

| Code          | L " | L mm | No. of teeth | €            |   |
|---------------|-----|------|--------------|--------------|---|
| <b>197509</b> | 4   | 100  | 20           | <b>4,59</b>  | 6 |
| <b>197510</b> | 6   | 150  | 16           | <b>5,39</b>  | 6 |
| <b>197512</b> | 8   | 200  | 14           | <b>8,08</b>  | 6 |
| <b>197514</b> | 10  | 250  | 12           | <b>11,25</b> | 6 |
| <b>197515</b> | 12  | 300  | 11           | <b>13,42</b> | 6 |
| <b>197516</b> | 14  | 350  | 10           | <b>14,62</b> | 6 |

### BASTARD CUT

| Code          | L " | L mm | No. of teeth | €            |   |
|---------------|-----|------|--------------|--------------|---|
| <b>197710</b> | 8   | 200  | 10           | <b>7,52</b>  | 6 |
| <b>197712</b> | 10  | 250  | 9            | <b>10,47</b> | 6 |
| <b>197714</b> | 12  | 300  | 8            | <b>12,48</b> | 6 |

Display with blister

**Round file**

**CARBON  
STEEL**



| SECOND CUT    |        |         |                 |             |   |
|---------------|--------|---------|-----------------|-------------|---|
| Code          | L<br>" | L<br>mm | No. of<br>teeth | €           |   |
| <b>197518</b> | 4      | 100     | 20              | <b>3,66</b> | 6 |
| <b>197519</b> | 6      | 150     | 16              | <b>4,58</b> | 6 |
| <b>197520</b> | 8      | 200     | 14              | <b>6,50</b> | 6 |
| <b>197521</b> | 10     | 250     | 12              | <b>8,91</b> | 6 |

| BASTARD CUT   |        |         |                 |             |   |
|---------------|--------|---------|-----------------|-------------|---|
| Code          | L<br>" | L<br>mm | No. of<br>teeth | €           |   |
| <b>197720</b> | 8      | 200     | 10              | <b>6,02</b> | 6 |
| <b>197721</b> | 10     | 250     | 9               | <b>8,29</b> | 6 |

Display with blister

**Square file**

**CARBON  
STEEL**



| SECOND CUT    |        |         |                |             |   |
|---------------|--------|---------|----------------|-------------|---|
| Code          | L<br>" | L<br>mm | No. of<br>teet | €           |   |
| <b>197524</b> | 6      | 150     | 16             | <b>4,43</b> | 6 |
| <b>197525</b> | 8      | 200     | 14             | <b>6,52</b> | 6 |
| <b>197526</b> | 10     | 250     | 12             | <b>8,97</b> | 6 |

| BASTARD CUT   |        |         |                |             |   |
|---------------|--------|---------|----------------|-------------|---|
| Code          | L<br>" | L<br>mm | No. of<br>teet | €           |   |
| <b>197725</b> | 8      | 200     | 10             | <b>5,84</b> | 6 |

Display with blister

**Triangular file**

**CARBON  
STEEL**



| SECOND CUT    |        |         |                |             |   |
|---------------|--------|---------|----------------|-------------|---|
| Code          | L<br>" | L<br>mm | No. of<br>teet | €           |   |
| <b>197528</b> | 4      | 100     | 20             | <b>3,82</b> | 6 |
| <b>197529</b> | 6      | 150     | 16             | <b>4,53</b> | 6 |
| <b>197530</b> | 8      | 200     | 14             | <b>6,90</b> | 6 |
| <b>197531</b> | 10     | 250     | 12             | <b>9,16</b> | 6 |

| BASTARD CUT   |        |         |                |             |   |
|---------------|--------|---------|----------------|-------------|---|
| Code          | L<br>" | L<br>mm | No. of<br>teet | €           |   |
| <b>197730</b> | 8      | 200     | 10             | <b>6,22</b> | 6 |

Display with blister

**Chainsaw file**

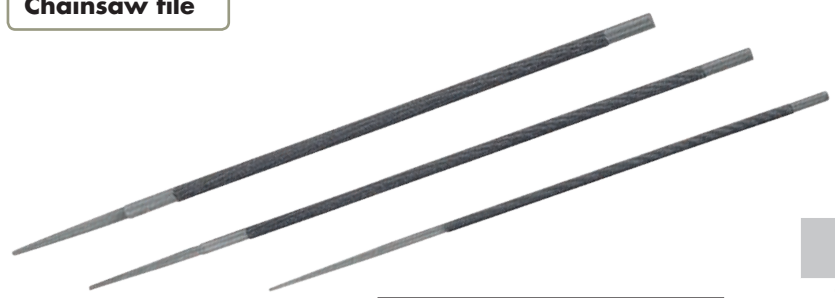

**Specially designed for  
sharpening chain saws**

| Code          | L<br>mm | Ø<br>mm | €           |   |
|---------------|---------|---------|-------------|---|
| <b>197601</b> | 150     | 3,5     | <b>2,00</b> | 6 |
| <b>197603</b> | 200     | 4,5     | <b>2,20</b> | 6 |
| <b>197605</b> | 200     | 5,5     | <b>2,35</b> | 6 |

Display with blister





## Files set, nylon pouch



### SECOND CUT 200 MM



#### CONTENTS

-  • 1 flat file of 200 mm (197502)
-  • 1 half round file of 200 mm (197512)
-  • 1 round file (197520)
-  • 1 square file (197525)
-  • 1 triangular file (197530)





| Code          | No. of items | €            |  |
|---------------|--------------|--------------|---|
| <b>197550</b> | 5            | <b>35,44</b> | 1   |



### SECOND CUT 150 MM



#### CONTENTS

-  • 1 flat file of 150 mm (197500)
-  • 1 half round file of 150 mm (197510)
-  • 1 round file 150 mm (197519)
-  • 1 square file 150 mm (197524)
-  • 1 triangular file 150 mm (197529)

| Code          | No. of items | €            |  |
|---------------|--------------|--------------|--|
| <b>197552</b> | 5            | <b>24,68</b> | 1  |





## Files set, nylon pouch



### BASTARD L 200 MM



#### CONTENTS

-  • 1 flat file of 200 mm (197702)
-  • 1 half round file of 200 mm (197710)
-  • 1 round file 200 mm (197720)
-  • 1 square file 200 mm (197725)
-  • 1 triangular file 200 mm (197730)

| Code          | No. of items | €            |  |
|---------------|--------------|--------------|---|
| <b>197554</b> | 5            | <b>35,31</b> | 1   |







## Needle files set



### Ø 3 MM L 100 MM

- Steel alloy of HRC62
- Length of blade 100 mm

#### CONTENTS

-  • 1 flat file of 100 mm
-  • 1 half round file of 100 mm
-  • 1 round file 100 mm
-  • 1 square file 100 mm
-  • 1 triangular file 100 mm
-  • 1 file plane tip of 100 mm

| Code          | No. of items | €            |  |
|---------------|--------------|--------------|---|
| <b>197495</b> | 6            | <b>10,70</b> | 1   |

**Half round rasp for woodworking**

CARBON STEEL



- Working area tempered between 60 - 65 HRC
- Special teeth for wood working
- Handle with ergonomic shape



| Code          | L<br>" | L<br>mm | €            |   |
|---------------|--------|---------|--------------|---|
| <b>197539</b> | 6      | 150     | <b>4,97</b>  | 6 |
| <b>197540</b> | 8      | 200     | <b>7,80</b>  | 6 |
| <b>197541</b> | 10     | 250     | <b>10,33</b> | 6 |

Display with hanger

**Flat rasp for woodworking**

CARBON STEEL

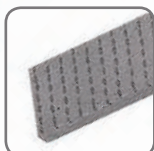

| Code          | L<br>" | L<br>mm | €           |   |
|---------------|--------|---------|-------------|---|
| <b>197534</b> | 6      | 150     | <b>4,59</b> | 6 |
| <b>197535</b> | 8      | 200     | <b>7,15</b> | 6 |
| <b>197536</b> | 10     | 250     | <b>9,75</b> | 6 |

Display with hanger

**Round rasp for woodworking**

CARBON STEEL



| Code          | L<br>" | L<br>mm | €           |   |
|---------------|--------|---------|-------------|---|
| <b>197544</b> | 6      | 150     | <b>4,20</b> | 6 |
| <b>197545</b> | 8      | 200     | <b>6,14</b> | 6 |
| <b>197546</b> | 10     | 250     | <b>8,52</b> | 6 |

Display with hanger

**Rasps for woodworking set**



L 200 MM



**CONTENTS**

- 1 200 mm flat rasp (197535)
- 1 200 mm half round rasp (197540)
- 1 200 mm round rasp (197545)

| Code          | No. of items | €            |   |
|---------------|--------------|--------------|---|
| <b>197549</b> | 3            | <b>21,10</b> | 1 |

**Mini rasps set, in plastic case**



Ø 3 MM  
L 100 MM

**CONTENTS**

- 1 flat minifile 100 mm long
- 1 half round minifile 100 mm long
- 1 round minifile 100 mm long
- 1 square minifile 100 mm long
- 1 triangular minifile 100 mm long
- 1 flat tip minifile 100 mm long

| Code          | No. of items | €            |   |
|---------------|--------------|--------------|---|
| <b>197497</b> | 6            | <b>13,32</b> | 1 |

## Crimped wire circular brush



For cleaning rust from forged and cast parts. Removal of all types of oxides, paint and burrs.



Each brush supplied with different central bushes diametres: Ø 12, 16, 20, 22, 25 and 32 mm

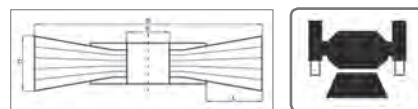

| Code          | Ø D mm | Raws | Width (C) | L mm | E mm | Max.RPM | €            |   |
|---------------|--------|------|-----------|------|------|---------|--------------|---|
| <b>197602</b> | 150    | 5    | 20        | 30   | 32   | 6500    | <b>14,44</b> | 1 |
| <b>197604</b> | 175    | 5    | 20        | 45   | 32   | 6000    | <b>15,94</b> | 1 |
| <b>197606</b> | 200    | 5    | 20        | 55   | 32   | 4500    | <b>18,12</b> | 1 |

Display in individual case

## Crimped wire circular brush



For cleaning rust from forged and cast parts. Removal of all types of oxides, paint and burrs.



Fastening of cup brush with an M14 threaded socket



| Code          | Ø D mm | Width C | L mm | Max. RPM | €            |   |
|---------------|--------|---------|------|----------|--------------|---|
| <b>197650</b> | 115    | 20      | 30   | 8500     | <b>10,12</b> | 1 |
| <b>197652</b> | 115    | 20      | 30   | 8500     | <b>19,50</b> | 1 |

Display in individual case

## Crimped wire cup brush for angle grinders



Specially designed for use with a angle grinder

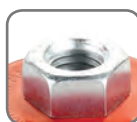

Fastening of cup brush with an M14 threaded socket



| Code          | Ø D mm | L mm | Max. RPM | €            |   |
|---------------|--------|------|----------|--------------|---|
| <b>197610</b> | 75     | 20   | 12500    | <b>10,49</b> | 1 |
| <b>197614</b> | 100    | 25   | 8500     | <b>13,28</b> | 1 |
| <b>197612</b> | 125    | 25   | 6500     | <b>19,30</b> | 1 |

Display in individual case

**Twist knot wire cup brush**



Fastening of cup brush with an M14 threaded socket



**Specially suitable for work on wide surfaces that requires a high material cutting capacity**



| Code          | Ø D mm | L mm | Max. RPM | €            |   |
|---------------|--------|------|----------|--------------|---|
| <b>197622</b> | 100    | 25   | 8500     | <b>16,71</b> | 1 |
| <b>197624</b> | 125    | 25   | 6500     | <b>20,77</b> | 1 |

Display in individual case

**Twist knot cup brush for angle grinders**

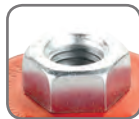

Fastening of cup brush with an M14 threaded socket



**Specially designed for use with a angle grinder**



| Code          | Ø D mm | L mm | Max. RPM | €            |   |
|---------------|--------|------|----------|--------------|---|
| <b>197620</b> | 75     | 25   | 12500    | <b>11,36</b> | 1 |

Display in individual case

**Rotary soft brush**



**Used to lift paint**

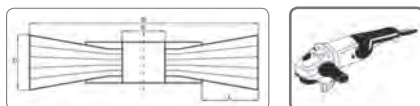

| Code          | Ø D mm | Width C | L mm | E mm | €           |   |
|---------------|--------|---------|------|------|-------------|---|
| <b>197651</b> | 100    | 15      | 35   | 12   | <b>9,28</b> | 6 |

Display with blister

**Rotary soft brush with shank**

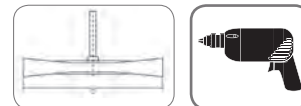

| Code          | Ø D mm | €           |   |
|---------------|--------|-------------|---|
| <b>197656</b> | 75     | <b>6,01</b> | 6 |

Display with blister

## Crimped wire rotary brush with shank



**Cleaning and removal of paint, rust and small burrs**

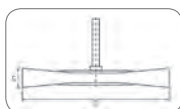

| Code          | Ø D mm | Width C | Max. RPM | €           |   |
|---------------|--------|---------|----------|-------------|---|
| <b>197630</b> | 50     | 6       | 4500     | <b>2,30</b> | 6 |
| <b>197632</b> | 75     | 6       | 4500     | <b>3,02</b> | 6 |
| <b>197635</b> | 100    | 6       | 4500     | <b>3,80</b> | 6 |

Display with blister

## Crimped wire cup brush with shank



| Code          | Ø D mm | L mm | Max. RPM | €           |   |
|---------------|--------|------|----------|-------------|---|
| <b>197640</b> | 50     | 20   | 4500     | <b>2,46</b> | 6 |
| <b>197642</b> | 75     | 20   | 4500     | <b>3,25</b> | 6 |

Display with blister

## Crimped wire flat trim brush with shank



**Particularly suitable for work in confined spaces**

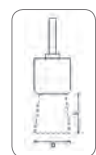

| Code          | Ø D mm | L mm | Max. RPM | €           |   |
|---------------|--------|------|----------|-------------|---|
| <b>197645</b> | 24     | 25   | 4500     | <b>3,54</b> | 6 |

Display with blister

## Nylon abrasive wheel brush with shank



Nylon filaments with abrasive grit

**For use in DIY works**

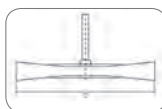

| Code          | Ø D mm | Max. RPM | €           |   |
|---------------|--------|----------|-------------|---|
| <b>197655</b> | 75     | 4500     | <b>6,85</b> | 6 |
| <b>197658</b> | 100    | 4500     | <b>8,07</b> | 6 |

Display with blister

## Nylon abrasive cup brush with shank



| Code          | Ø D mm | L mm | Max. RPM | €           |   |
|---------------|--------|------|----------|-------------|---|
| <b>197660</b> | 50     | 20   | 4500     | <b>7,00</b> | 6 |
| <b>197662</b> | 75     | 20   | 4500     | <b>7,91</b> | 6 |

Display with blister

**Heavy duty wire brush**

**25% MORE DENSITY OF WIRES**

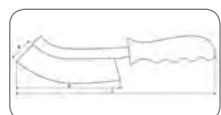

**Brushes for light tasks. Particularly suitable for brushing in confined spaces**

| Code          | L mm | A mm | S mm | €           |    |
|---------------|------|------|------|-------------|----|
| <b>197556</b> | 225  | 28   | 125  | <b>2,40</b> | 24 |

**Wire brush**



**Wire brush for stainless steel**

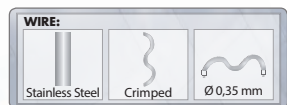

Particularly suitable for brushing stainless Steel

| Code          | L mm | A mm | S mm | €           |    |
|---------------|------|------|------|-------------|----|
| <b>197555</b> | 225  | 28   | 125  | <b>1,91</b> | 24 |

| Code          | L mm | A mm | S mm | €           |    |
|---------------|------|------|------|-------------|----|
| <b>197558</b> | 225  | 28   | 125  | <b>4,96</b> | 24 |

**Brass coated steel minibrush**

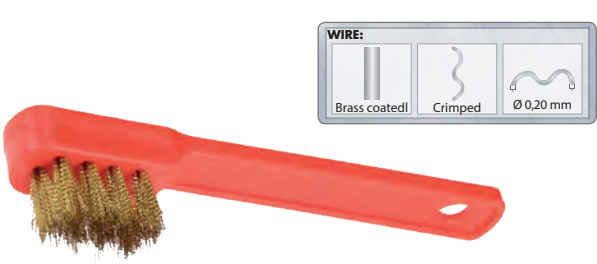

**Stainless steel minibrush**



Particularly suitable for brushing stainless Steel

| Code          | L mm | €           |    |
|---------------|------|-------------|----|
| <b>197561</b> | 150  | <b>1,90</b> | 24 |

| Code          | L mm | €           |    |
|---------------|------|-------------|----|
| <b>197562</b> | 150  | <b>2,10</b> | 24 |

**Scratch wire brushes with wooden handle**

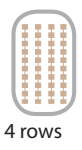

Brushes for cleaning of paint-work, oxides and small burrs etc.

| Code          | L mm | A mm | S mm | €           |    |
|---------------|------|------|------|-------------|----|
| <b>197560</b> | 300  | 28   | 135  | <b>2,21</b> | 12 |

**Hand foundry brush**

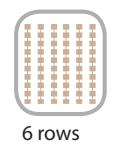

For heavy brushing tasks

| Code          | L mm | A mm | €           |    |
|---------------|------|------|-------------|----|
| <b>197565</b> | 200  | 34   | <b>3,80</b> | 12 |

## Bimetal hole saw



### BIMETAL

Very suitable for cutting steel, hardwood, plywood and plastics in general

Maximum cutting depth of 38 mm

- High speed steel teeth. Tempered between 63-65 HRC
- Body of hole saws made of alloy steel of high flexibility
- Teeth welded to the body

4/6 variable pitch teeth with positive cutting angle

Side openings for removal of cut material

Solid cap for reducing the vibrations during cutting work

### TECHNICAL DIRECTIONS:

A user guide is included in each box with the max. RPMs depending on the material to be cut and the hole saw diameter.

| Code   | Ø mm | €     |   | Code   | Ø mm | €     |   | Code   | Ø mm | €     |   |
|--------|------|-------|---|--------|------|-------|---|--------|------|-------|---|
| 197014 | 14   | 8,24  | 1 | 197041 | 41   | 11,76 | 1 | 197076 | 76   | 18,13 | 1 |
| 197016 | 16   | 8,24  | 1 | 197043 | 43   | 12,03 | 1 | 197079 | 79   | 18,87 | 1 |
| 197017 | 17   | 8,24  | 1 | 197044 | 44   | 12,47 | 1 | 197083 | 83   | 19,78 | 1 |
| 197019 | 19   | 8,24  | 1 | 197046 | 46   | 12,78 | 1 | 197086 | 86   | 20,08 | 1 |
| 197020 | 20   | 8,24  | 1 | 197048 | 48   | 12,78 | 1 | 197089 | 89   | 20,86 | 1 |
| 197021 | 21   | 8,53  | 1 | 197051 | 51   | 13,17 | 1 | 197092 | 92   | 22,77 | 1 |
| 197022 | 22   | 8,53  | 1 | 197052 | 52   | 13,26 | 1 | 197095 | 95   | 24,53 | 1 |
| 197024 | 24   | 8,92  | 1 | 197054 | 54   | 13,49 | 1 | 197098 | 98   | 25,54 | 1 |
| 197025 | 25   | 8,92  | 1 | 197056 | 56   | 13,69 | 1 | 197102 | 102  | 26,97 | 1 |
| 197027 | 27   | 9,60  | 1 | 197057 | 57   | 13,87 | 1 | 197105 | 105  | 28,40 | 1 |
| 197029 | 29   | 9,60  | 1 | 197059 | 59   | 14,25 | 1 | 197108 | 108  | 34,83 | 1 |
| 197030 | 30   | 10,34 | 1 | 197060 | 60   | 14,62 | 1 | 197111 | 111  | 37,48 | 1 |
| 197032 | 32   | 10,34 | 1 | 197064 | 64   | 15,29 | 1 | 197114 | 114  | 42,17 | 1 |
| 197033 | 33   | 10,34 | 1 | 197065 | 65   | 15,64 | 1 | 197121 | 121  | 48,30 | 1 |
| 197035 | 35   | 11,05 | 1 | 197067 | 67   | 16,02 | 1 | 197127 | 127  | 51,61 | 1 |
| 197037 | 37   | 11,19 | 1 | 197068 | 68   | 16,34 | 1 | 197140 | 140  | 61,15 | 1 |
| 197038 | 38   | 11,36 | 1 | 197070 | 70   | 16,72 | 1 | 197152 | 152  | 65,24 | 1 |
| 197040 | 40   | 11,76 | 1 | 197073 | 73   | 17,45 | 1 |        |      |       |   |

## Arbor for hole saws

FOR HOLE SAWS  
Ø 14-30 MM



- Arbors made of alloy steel of high elasticity
- Pilot drill made of high speed steel (HSS)

FOR HOLE SAWS  
Ø 32-152 MM



| Code   | Hexag. | €     |   |
|--------|--------|-------|---|
| 197210 | 3/8"   | 10,48 | 1 |

| Code   | Hexag. | €     |   |
|--------|--------|-------|---|
| 197200 | 7/16"  | 17,96 | 1 |

**SDS plus arbor for hole saws**

**FOR HOLE SAWS  
Ø 32-152 MM**



SDS-Plus shank

| Code          | €            |   |
|---------------|--------------|---|
| <b>197212</b> | <b>19,69</b> | 1 |

**Electrician's hole saw set**



**CONTENTS**

- 6 Bimetal hole saws: 22, 29, 35, 44, 51, 64 mm
- 2 Arbours for hole saws: 7/16" (32-152), 3/8" (14-30)
- 1 Hex key for arbors

| Code          | No. of items | €            |   |
|---------------|--------------|--------------|---|
| <b>197160</b> | 9            | <b>89,19</b> | 1 |

**Plumber & electrician's hole saw set**



**CONTENTS**

- 9 Bimetal hole saws: 19, 22, 29, 35, 38, 44, 51, 57, 64 mm
- 2 Arbours for hole saws: 7/16" (32-152), 3/8" (14-30)
- 1 Hex key for arbors

| Code          | No. of items | €             |   |
|---------------|--------------|---------------|---|
| <b>197170</b> | 12           | <b>118,78</b> | 1 |

**Spare pilot drill for arbors**



| Code          | L mm     | €           |    |
|---------------|----------|-------------|----|
| <b>197215</b> | 1/4"x81  | <b>3,77</b> | 10 |
| <b>197220</b> | 1/4"x102 | <b>3,92</b> | 10 |

**Hole saw arbor extension bar**



| Code          | L mm | €            |   |
|---------------|------|--------------|---|
| <b>197250</b> | 300  | <b>15,04</b> | 1 |

**Hole saw adapter**



• Adapter for use with hole saws from 32 mm onwards with 3/8" arbor

| Code          | €           |    |
|---------------|-------------|----|
| <b>197230</b> | <b>5,41</b> | 10 |

**Hole saw spring**



| Code          | €           |    |
|---------------|-------------|----|
| <b>197240</b> | <b>0,94</b> | 10 |

## HSS twist drill for metal

DIN 338

HSS STEEL

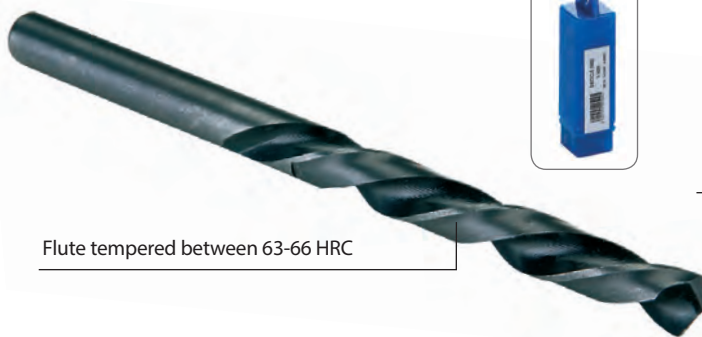

Flute tempered between 63-66 HRC



135° angle point

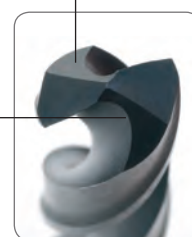

Split point sharpening

| Code   | Ø mm | €    |    | Code   | Ø mm | €    |    | Code   | Ø mm  | €    |    |
|--------|------|------|----|--------|------|------|----|--------|-------|------|----|
| 120100 | 1    | 0,49 | 10 | 120525 | 5,25 | 1,22 | 10 | 120925 | 9,25  | 3,76 | 10 |
| 120125 | 1,25 | 0,59 | 10 | 120550 | 5,50 | 1,22 | 10 | 120950 | 9,50  | 3,33 | 10 |
| 120150 | 1,50 | 0,54 | 10 | 120575 | 5,75 | 1,52 | 10 | 120975 | 9,75  | 4,06 | 10 |
| 120175 | 1,75 | 0,68 | 10 | 120600 | 6    | 1,33 | 10 | 121000 | 10    | 3,66 | 10 |
| 120200 | 2    | 0,56 | 10 | 120625 | 6,25 | 1,73 | 10 | 121025 | 10,25 | 4,61 | 5  |
| 120225 | 2,25 | 0,69 | 10 | 120650 | 6,50 | 1,57 | 10 | 121050 | 10,50 | 4,34 | 5  |
| 120250 | 2,50 | 0,66 | 10 | 120675 | 6,75 | 1,99 | 10 | 121075 | 10,75 | 5,23 | 5  |
| 120275 | 2,75 | 0,85 | 10 | 120700 | 7    | 1,87 | 10 | 121100 | 11    | 4,72 | 5  |
| 120300 | 3    | 0,62 | 10 | 120725 | 7,25 | 2,23 | 10 | 121125 | 11,25 | 5,81 | 5  |
| 120325 | 3,25 | 0,80 | 10 | 120750 | 7,50 | 2,02 | 10 | 121150 | 11,50 | 5,10 | 5  |
| 120350 | 3,50 | 0,74 | 10 | 120775 | 7,75 | 2,49 | 10 | 121175 | 11,75 | 6,05 | 5  |
| 120375 | 3,75 | 0,87 | 10 | 120800 | 8    | 2,33 | 10 | 121200 | 12    | 5,74 | 5  |
| 120400 | 4    | 0,82 | 10 | 120825 | 8,25 | 2,95 | 10 | 121225 | 12,25 | 6,70 | 5  |
| 120425 | 4,25 | 0,93 | 10 | 120850 | 8,50 | 2,68 | 10 | 121250 | 12,50 | 6,22 | 5  |
| 120450 | 4,50 | 0,93 | 10 | 120875 | 8,75 | 3,35 | 10 | 121275 | 12,75 | 7,47 | 5  |
| 120475 | 4,75 | 1,18 | 10 | 120900 | 9    | 2,86 | 10 | 121300 | 13    | 6,58 | 5  |
| 120500 | 5    | 0,99 | 10 |        |      |      |    |        |       |      |    |

## HSS twist drill set in plastic case



**CONTENTS** 1-10 x 0,5 mm  
1, 1'5, 2, 2'5, 3, 3'5, 4, 4'5, 5, 5'5, 6, 6'5, 7, 7'5, 8, 8'5, 9, 9'5, 10 mm

| Code   | No. of items | €     |   |
|--------|--------------|-------|---|
| 121320 | 19           | 34,04 | 1 |



**CONTENTS** 1-13 x 0,5 mm  
1, 1'5, 2, 2'5, 3, 3'5, 4, 4'5, 5, 5'5, 6, 6'5, 7, 7'5, 8, 8'5, 9, 9'5, 10, 10'5, 11, 11'5, 12, 12'5, 13 mm

| Code   | No. of items | €     |   |
|--------|--------------|-------|---|
| 121330 | 25           | 69,88 | 1 |

**HSS twist drill set**



**CONTENTS** 1, 2, 3, 4, 5, 6, 7, 8, 9, 10 mm

| Code          | No. of items | €            |   |
|---------------|--------------|--------------|---|
| <b>121310</b> | 10           | <b>21,23</b> | 1 |

**Tap and die set**



**CONTENTS** 1-10 x 0,5 mm  
1, 1'5, 2, 2'5, 3, 3'5, 4, 4'5, 5, 5'5, 6, 6'5, 7, 7'5, 8, 8'5, 9, 9'5, 10 mm

| Code          | No. of items | €            |   |
|---------------|--------------|--------------|---|
| <b>121335</b> | 19           | <b>31,44</b> | 1 |

**Tap wrench**



| Code          | For metric | L mm | €           |   |
|---------------|------------|------|-------------|---|
| <b>122347</b> | M3 - M12   | 210  | <b>9,39</b> | 1 |

Display with blister

**Die holder**



| Code          | Ø mm | L mm | €           |   |
|---------------|------|------|-------------|---|
| <b>122342</b> | 25,4 | 210  | <b>7,10</b> | 1 |

Display with blister

**T-type tap wrench**

Cr-V  
STEEL



• Satin finish coating

| Code          | For metric | L mm | €            |   |
|---------------|------------|------|--------------|---|
| <b>122340</b> | M3 - M8    | 85   | <b>21,35</b> | 1 |
| <b>122345</b> | M5 - M12   | 100  | <b>24,88</b> | 1 |

Display with hanger

## Concrete drill, straight shank

DIN 8039

CARBON STEEL

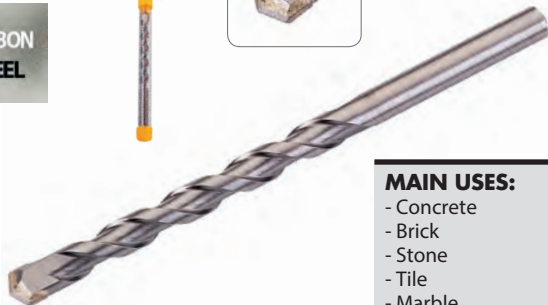

### MAIN USES:

- Concrete
- Brick
- Stone
- Tile
- Marble
- Granite
- Slate
- etc.

- Shank made of carbon Steel tempered
- Milled flute
- Tip made of Tungsten carbide, for a high cutting performance and longer life.
- High resistance to wear and torsion stress



Do not use for metal drilling

| Code   | Ø mm | L mm | €     |    |
|--------|------|------|-------|----|
| 122003 | 3    | 70   | 1,47  | 10 |
| 122004 | 4    | 75   | 1,56  | 10 |
| 122005 | 5    | 85   | 1,66  | 10 |
| 122006 | 6    | 100  | 1,81  | 10 |
| 122036 | 6    | 200  | 3,20  | 5  |
| 122046 | 6    | 400  | 6,24  | 1  |
| 122007 | 7    | 100  | 2,18  | 10 |
| 122008 | 8    | 120  | 2,51  | 10 |
| 122038 | 8    | 200  | 3,67  | 5  |
| 122048 | 8    | 400  | 6,58  | 1  |
| 122009 | 9    | 120  | 3,02  | 5  |
| 122010 | 10   | 120  | 3,25  | 10 |
| 122040 | 10   | 200  | 5,26  | 5  |
| 122050 | 10   | 400  | 8,97  | 1  |
| 122011 | 11   | 150  | 4,64  | 5  |
| 122012 | 12   | 150  | 4,70  | 5  |
| 122052 | 12   | 400  | 11,36 | 1  |
| 122013 | 13   | 150  | 6,49  | 5  |
| 122014 | 14   | 150  | 6,97  | 5  |
| 122054 | 14   | 400  | 13,64 | 1  |
| 122015 | 15   | 150  | 8,45  | 1  |
| 122016 | 16   | 150  | 8,65  | 1  |
| 122056 | 16   | 400  | 16,83 | 1  |
| 122018 | 18   | 160  | 10,89 | 1  |
| 122058 | 18   | 400  | 19,24 | 1  |
| 122020 | 20   | 160  | 12,73 | 1  |
| 122060 | 20   | 400  | 22,65 | 1  |
| 122022 | 22   | 160  | 15,44 | 1  |
| 122062 | 22   | 400  | 26,36 | 1  |

Display with hanger

## Concrete drill, SDS plus shank

CARBON STEEL

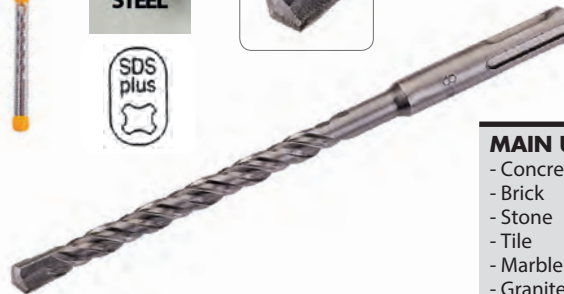

### MAIN USES:

- Concrete
- Brick
- Stone
- Tile
- Marble
- Granite
- Slate
- etc.

- Made of alloy steel tempered between 42-50 HRC
- Flute with 4 slots for a better removal of cut material provides higher drilling speed
- Tip made of Tungsten carbide for a high cutting performance
- Sand blasted finish and anti-rust oil treatment
- Drill can be used for hammering jobs



Do not use for metal drilling

| Code   | Ø mm | L mm | €     |   |
|--------|------|------|-------|---|
| 122104 | 4    | 110  | 3,97  | 5 |
| 122105 | 5    | 110  | 3,97  | 5 |
| 122106 | 6    | 110  | 3,97  | 5 |
| 122126 | 6    | 210  | 6,74  | 1 |
| 122146 | 6    | 260  | 10,23 | 1 |
| 122107 | 7    | 110  | 5,07  | 5 |
| 122108 | 8    | 110  | 5,07  | 5 |
| 122128 | 8    | 210  | 6,43  | 1 |
| 122148 | 8    | 260  | 9,30  | 1 |
| 122109 | 9    | 110  | 5,29  | 5 |
| 122110 | 10   | 110  | 5,56  | 5 |
| 122130 | 10   | 210  | 7,87  | 1 |
| 122150 | 10   | 260  | 9,94  | 1 |
| 122111 | 11   | 160  | 7,23  | 1 |
| 122112 | 12   | 160  | 7,28  | 1 |
| 122132 | 12   | 210  | 8,83  | 1 |
| 122152 | 12   | 260  | 10,65 | 1 |
| 122113 | 13   | 160  | 11,51 | 1 |
| 122114 | 14   | 160  | 11,77 | 1 |
| 122134 | 14   | 210  | 12,96 | 1 |
| 122154 | 14   | 260  | 14,70 | 1 |
| 122115 | 15   | 160  | 13,25 | 1 |
| 122116 | 16   | 160  | 13,36 | 1 |
| 122136 | 16   | 210  | 16,23 | 1 |
| 122156 | 16   | 260  | 18,01 | 1 |
| 122117 | 17   | 210  | 21,80 | 1 |
| 122118 | 18   | 210  | 21,87 | 1 |
| 122119 | 19   | 210  | 23,73 | 1 |
| 122120 | 20   | 210  | 23,99 | 1 |

Display with hanger

**Concrete drill set in plastic case**



| CONTENTS 5x110, 6x110, 8x110, 10x110 mm |              |              |   |
|---|--------------|--------------|---|
| Code                                    | No. of items | €            |   |
| <b>122170</b>                           | 4            | <b>19,55</b> | 1 |



| CONTENTS 5x110, 6x110, 8x110, 8x160, 10x160, 12x160 mm |              |              |   |
|--|--------------|--------------|---|
| Code   | No. of items | €            |   |
| <b>122180</b>  | 6            | <b>32,93</b> | 1 |



| CONTENTS 4x75, 5x85, 6x100, 8x120, 10x120 mm |              |              |   |
|--|--------------|--------------|---|
| Code   | No. of items | €            |   |
| <b>122070</b>                                | 5            | <b>11,10</b> | 1 |



| CONTENTS 3x70, 4x75, 5x85, 6x100, 7x100, 8x120, 9x120, 10x120 mm |              |              |   |
|--|--------------|--------------|---|
| Code   | No. of items | €            |   |
| <b>122080</b>  | 8            | <b>17,50</b> | 1 |

**Wood and plastic drill**



| Code          | Ø mm | €            |    |
|---------------|------|--------------|----|
| <b>136001</b> | 3    | <b>2,29</b>  | 12 |
| <b>136002</b> | 4    | <b>2,32</b>  | 12 |
| <b>136003</b> | 5    | <b>2,48</b>  | 12 |
| <b>136004</b> | 6    | <b>2,49</b>  | 12 |
| <b>136005</b> | 7    | <b>2,75</b>  | 12 |
| <b>136006</b> | 8    | <b>2,80</b>  | 12 |
| <b>136007</b> | 9    | <b>3,49</b>  | 12 |
| <b>136008</b> | 10   | <b>3,68</b>  | 12 |
| <b>136009</b> | 11   | <b>4,30</b>  | 12 |
| <b>136010</b> | 12   | <b>5,31</b>  | 12 |
| <b>136011</b> | 13   | <b>5,93</b>  | 12 |
| <b>136012</b> | 14   | <b>7,41</b>  | 12 |
| <b>136013</b> | 15   | <b>9,46</b>  | 12 |
| <b>136014</b> | 16   | <b>11,36</b> | 12 |

**Wood and plastic drill set in plastic case**



| CONTENTS 4, 5, 6, 8, 10 mm |              |              |   |
|----------------------------|--------------|--------------|---|
| Code                       | No. of items | €            |   |
| <b>136205</b>              | 5            | <b>11,71</b> | 1 |



| CONTENTS 3, 4, 5, 6, 7, 8, 9, 10 mm |              |              |   |
|-------------------------------------|--------------|--------------|---|
| Code                                | No. of items | €            |   |
| <b>136208</b>                       | 8            | <b>15,47</b> | 1 |

## Flat wood bit



Quick holding system (with slotted shank)

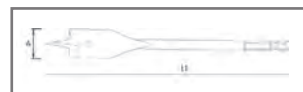

| Code   | Ø mm | €    |    | Code   | Ø mm | €    |    | Code   | Ø mm | €    |    |
|--------|------|------|----|--------|------|------|----|--------|------|------|----|
| 135011 | 6    | 3,92 | 12 | 135004 | 19   | 5,70 | 12 | 135008 | 30   | 7,32 | 12 |
| 135012 | 8    | 5,13 | 12 | 135016 | 20   | 6,04 | 12 | 135009 | 32   | 7,39 | 12 |
| 135001 | 10   | 5,44 | 12 | 135005 | 22   | 6,14 | 12 | 135019 | 34   | 7,76 | 12 |
| 135002 | 12   | 5,46 | 12 | 135017 | 24   | 6,18 | 12 | 135010 | 35   | 7,90 | 12 |
| 135013 | 14   | 5,65 | 12 | 135006 | 25   | 6,21 | 12 | 135020 | 36   | 7,92 | 12 |
| 135003 | 16   | 5,66 | 12 | 135018 | 26   | 6,24 | 12 | 135021 | 38   | 8,17 | 12 |
| 135014 | 17   | 5,67 | 12 | 135007 | 28   | 7,27 | 12 | 135022 | 40   | 8,18 | 12 |
| 135015 | 18   | 5,68 | 12 |        |      |      |    |        |      |      |    |

Display with hanger

## Flat wood bit set in nylon pouch



### CONTENTS

**135070** 10, 12, 16, 19, 22, 25 mm  
**135080** 8, 10, 12, 14, 16, 19, 20, 22, 25, 30, 32, 35, 38 mm + extension bar + hex key

| Code   | No. of items | €     |   |
|--------|--------------|-------|---|
| 135070 | 6            | 29,13 | 1 |
| 135080 | 15           | 62,66 | 1 |

Display with blister

## Flat wood bits extension bar



• Total length of bit with extension bar 450 mm

| Code   | L mm | €     |   |
|--------|------|-------|---|
| 135051 | 300  | 14,01 | 6 |

## Carbide tip forstner bit

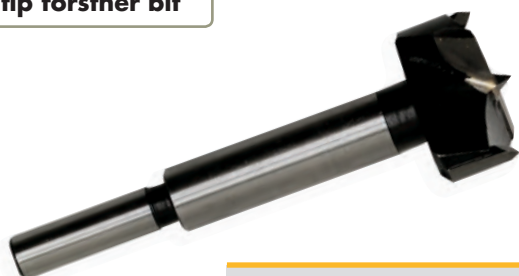

• Welded tungsten carbide tipped forstner bit

| Code   | Ø mm | L mm | €     |   |
|--------|------|------|-------|---|
| 138010 | 15   | 90   | 8,34  | 6 |
| 138011 | 20   | 90   | 11,85 | 6 |
| 138001 | 26   | 90   | 13,76 | 6 |
| 138002 | 30   | 90   | 15,29 | 6 |
| 138003 | 35   | 90   | 16,93 | 6 |
| 138012 | 40   | 90   | 20,53 | 6 |
| 138013 | 45   | 90   | 23,37 | 6 |
| 138014 | 50   | 90   | 25,35 | 6 |

**Screw auger bits with hex shank**



**LENGTH 400 MM**



Longer flute (300 mm)

NEW HOLDING SYSTEM:  
 - Hex shank of 1/2"  
 - Quick holding slot for pneumatic and electrical appliances

- Double slot flute for a higher cutting capacity
- Screw auger bit with double cutting edge
- Tip with thread guide
- Ground cutting edges

| Code          | Ø mm | €            |   |
|---------------|------|--------------|---|
| <b>131110</b> | 10   | <b>19,28</b> | 6 |
| <b>131112</b> | 12   | <b>19,86</b> | 6 |
| <b>131114</b> | 14   | <b>21,00</b> | 6 |
| <b>131116</b> | 16   | <b>23,29</b> | 6 |
| <b>131117</b> | 17   | <b>24,29</b> | 6 |
| <b>131118</b> | 18   | <b>25,55</b> | 6 |
| <b>131120</b> | 20   | <b>26,27</b> | 6 |

**Screw auger bit with eye**

**LENGTH 400 MM  
DOUBLE CUTTING EDGE**



**Used for shuttering and railroad sleepers**

| Code          | Ø mm | €            |   |
|---------------|------|--------------|---|
| <b>131002</b> | 8    | <b>18,97</b> | 6 |
| <b>131004</b> | 10   | <b>20,05</b> | 6 |
| <b>131006</b> | 12   | <b>20,64</b> | 6 |
| <b>131008</b> | 14   | <b>21,83</b> | 6 |
| <b>131010</b> | 16   | <b>24,22</b> | 6 |
| <b>131011</b> | 17   | <b>25,27</b> | 6 |
| <b>131012</b> | 18   | <b>26,59</b> | 6 |
| <b>131014</b> | 20   | <b>27,33</b> | 6 |
| <b>131016</b> | 22   | <b>29,56</b> | 6 |
| <b>131018</b> | 24   | <b>33,52</b> | 6 |
| <b>131020</b> | 26   | <b>35,44</b> | 6 |
| <b>131022</b> | 28   | <b>39,17</b> | 6 |
| <b>131024</b> | 30   | <b>39,78</b> | 6 |

**Screw auger bit with half-round shank**

**DOUBLE CUTTING EDGE**

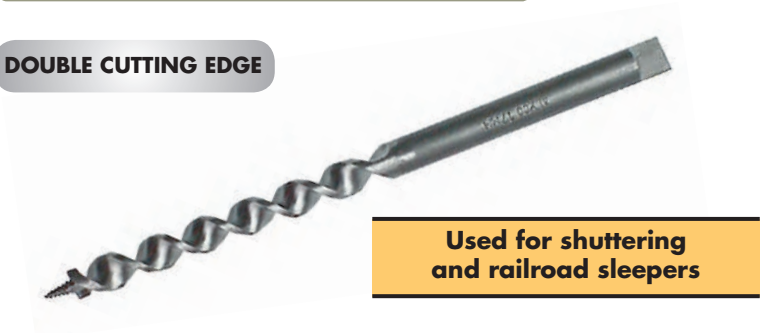

**Used for shuttering and railroad sleepers**

| Code          | Ø mm | L mm | €            |    |
|---------------|------|------|--------------|----|
| <b>131031</b> | 16   | 285  | <b>28,11</b> | 10 |
| <b>131032</b> | 17   | 285  | <b>30,19</b> | 10 |
| <b>131033</b> | 18   | 285  | <b>31,37</b> | 10 |
| <b>132009</b> | 17   | 224  | <b>28,12</b> | 10 |

**Hand drill**



| Code          | Ø mm | €            |   |
|---------------|------|--------------|---|
| <b>151001</b> | 0-13 | <b>48,83</b> | 1 |



## 10 Gardening



Pruning shears

195



Gathering shears

196



Hedge shears

197



Pruning saw

198

### Rotating handle pruning shears



#### CUTTING CAPACITY



30%

Reduces fatigue

SK5 steel blade with high cutting capacity and longer service life

| Code          | L mm | L " | €            |    |
|---------------|------|-----|--------------|----|
| <b>108420</b> | 220  | 9   | <b>26,20</b> | 10 |

Display with blister

### Aluminum handle pruning shears



Capacity Cutting



- Forged Aluminum Body
- Automatic opening spring
- Ergonomic non-slip handles
- Safety lock

| Code          | L mm | L " | €            |    |
|---------------|------|-----|--------------|----|
| <b>108415</b> | 220  | 9   | <b>16,40</b> | 10 |

Display with blister

### Steel handles pruning shears



Capacity Cutting



- Handles made of Steel
- Automatic opening spring
- Ergonomic non-slip handles
- Safety lock

| Code          | L mm | L " | €            |    |
|---------------|------|-----|--------------|----|
| <b>108425</b> | 220  | 9   | <b>13,20</b> | 10 |

Display with blister

## Forged pruning shears



**FORGED  
SHEARS**

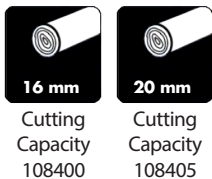

- Tempered cutting edges
- Easy and clean by-pass cutting
- Automatic opening spring
- With safety lock

| Code          | L mm | L " | €           |   |
|---------------|------|-----|-------------|---|
| <b>108400</b> | 180  | 7   | <b>7,20</b> | 6 |
| <b>108405</b> | 220  | 8,5 | <b>8,82</b> | 6 |

Display with blister

## Gathering shears



- Black coated cutting blades
- Automatic opening spring
- Ergonomic ABS plastic handles
- Safety lock

| Code          | L mm | L " | €           |    |
|---------------|------|-----|-------------|----|
| <b>108410</b> | 180  | 7   | <b>5,80</b> | 10 |

Display with blister

## Sharpener



Sharpening



Oiling



- Tungsten carbide edge
- Plastic body
- For sharpening all kinds of scissors and knives

| Code          | L mm | €           |    |
|---------------|------|-------------|----|
| <b>108492</b> | 200  | <b>9,80</b> | 10 |

Display with blister

## Coarse sharpener



Sharpening



Oiling



**SPECIAL  
FOR SMOOTHING**



- Tungsten carbide edge
- Plastic body
- For sharpening all kinds of scissors and knives

| Code          | L mm | €           |    |
|---------------|------|-------------|----|
| <b>108490</b> | 120  | <b>9,40</b> | 10 |

Display with blister



**Lopping shears**



**35 mm**  
Cutting Capacity



Ergonomic non-slip handles

Pipe handles made of very light aluminum

Teflon upper cutting blade. Chromed lower blade



With safety stops

| Code          | L mm | L " | €            |   |
|---------------|------|-----|--------------|---|
| <b>108520</b> | 680  | 27  | <b>24,20</b> | 1 |

**Extendable handles lopping shears**

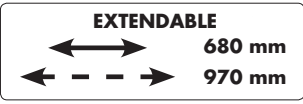

**35 mm**  
Cutting Capacity



Folded 680 mm long



Handle extension with locking system

Same features as 108520

| Code          | L mm    | L "   | €            |   |
|---------------|---------|-------|--------------|---|
| <b>108525</b> | 680-970 | 27-39 | <b>28,70</b> | 1 |

**Compound action lopping shears**



**45 mm**  
Cutting Capacity



Aluminum pipe handles

Ratched action



Compound action

- Ergonomic non-slip handles
- Teflon upper blade. Aluminium lower blade

| Code          | L mm | L " | €            |   |
|---------------|------|-----|--------------|---|
| <b>108530</b> | 820  | 33  | <b>29,30</b> | 1 |

## Garden shears

210 MM  
TEFLON EDGES



Ergonomic non-slip handles

Very light aluminum tubular handles

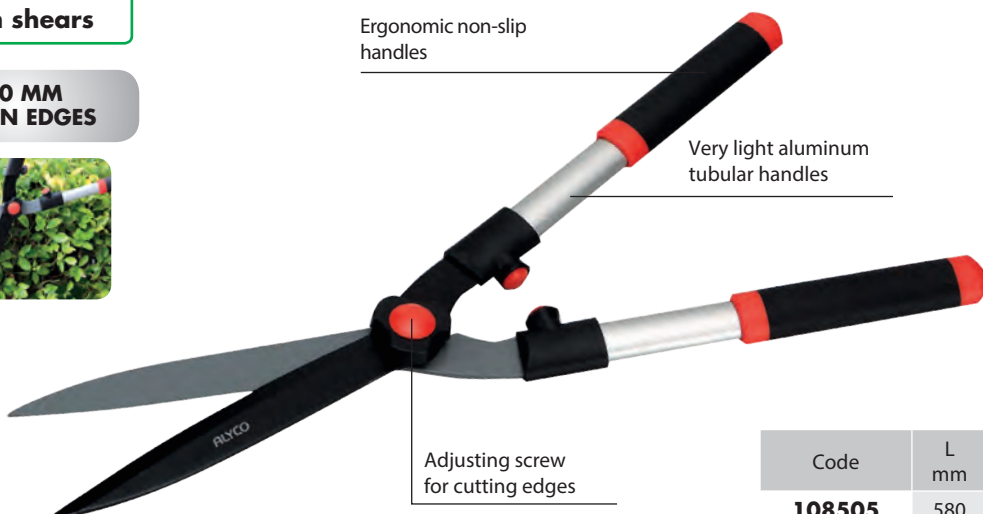

Adjusting screw for cutting edges

NEW



Buffer stops

| Code          | L mm | L " | €            |   |
|---------------|------|-----|--------------|---|
| <b>108505</b> | 580  | 23  | <b>22,30</b> | 1 |

## Telescopic garden shears

EXTENDABLE

660 mm  
860 mm



Folded 660 mm long

NEW



Handle extension with locking system

Same features as 108505

| Code          | L mm    | L "   | €            |   |
|---------------|---------|-------|--------------|---|
| <b>108510</b> | 660-860 | 26-34 | <b>27,36</b> | 1 |

## Pruning saw

BLADE 330 MM LONG

TRIANGULAR TEETH

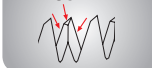

NEW

• Plastic belt shaft included

| Code          | L mm | L " | €            |    |
|---------------|------|-----|--------------|----|
| <b>144092</b> | 480  | 19  | <b>12,50</b> | 12 |

## Folding pruning saw

BLADE 180 MM LONG



• Folding saw with safety lock  
• Ergonomic bi-material handle

| Code          | L open mm | L close mm | €            |   |
|---------------|-----------|------------|--------------|---|
| <b>144097</b> | 400       | 240        | <b>10,81</b> | 6 |



**Hand trowel**



| Code          | Dimensions mm | €           |    |
|---------------|---------------|-------------|----|
| <b>108550</b> | 350 x 80      | <b>4,40</b> | 12 |

**Hand cultivator**



| Code          | Dimensions mm | €           |    |
|---------------|---------------|-------------|----|
| <b>108555</b> | 325 x 80      | <b>4,40</b> | 12 |

**Garden fork and trowel**

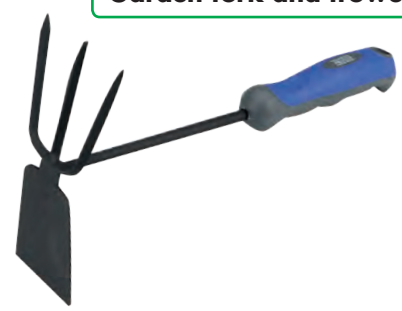

| Code          | Dimensions mm | €           |    |
|---------------|---------------|-------------|----|
| <b>108560</b> | 325 x 80 x 75 | <b>4,40</b> | 12 |

**Steel lawn rake**



• Made of carbon steel

| Code          | No. Tines | Dimensions mm | €           |   |
|---------------|-----------|---------------|-------------|---|
| <b>198518</b> | 22        | 425 x 400     | <b>4,37</b> | 6 |

Supplied without handle

**Plastic lawn rake**



• Made of PVC

| Code          | No. Tines | Dimensions mm | €           |   |
|---------------|-----------|---------------|-------------|---|
| <b>198520</b> | 22        | 480 x 430     | <b>4,26</b> | 6 |

Supplied without handle

**Rake handles**

| Image | Code          | For Code | Type     | L mm | Ø mm | €           |   |
|-------|---------------|----------|----------|------|------|-------------|---|
|       | <b>198519</b> | 198518   | Straight | 1200 | 24   | <b>3,75</b> | 6 |
|       | <b>198521</b> | 198520   | Straight | 1200 | 24   | <b>3,86</b> | 6 |

**Nylon bag for shears**



Possibility of adjustment to pocket or belt



| Code          | Dimensions mm | €           |   |
|---------------|---------------|-------------|---|
| <b>196848</b> | 220 X 90      | <b>4,50</b> | 1 |



## 11 Construction



Shovel 201



Aluminium shovel 202



Plastic shovel 202



Hoe 203



Rake 204



Plumb bob 205



Forged trowel 206



Trowel 209



Float 210



Scraper 211



Wrecking bar 213



Scaffolding wrench 213



Clamp 214



Plastic clamp 215



Plastic spring clamp 215



Nylon pouch 216

**Round point shovel, wooden T-handle**



T-handle

See handles on page 203

| Code          | Dimensions mm | L mm | €            |   |
|---------------|---------------|------|--------------|---|
| <b>198600</b> | 280x340       | 1000 | <b>15,30</b> | 6 |

**Round point shove, metal ring handle**



Metal ring handle

See handles on page 203

| Code          | Dimensions mm | L mm | €            |   |
|---------------|---------------|------|--------------|---|
| <b>198610</b> | 280x340       | 1000 | <b>17,52</b> | 6 |

**Square shove, wooden T-handle**



T-handle

See handles on page 203

| Code          | Dimensions mm | L mm | €            |   |
|---------------|---------------|------|--------------|---|
| <b>198605</b> | 280x340       | 1000 | <b>15,60</b> | 6 |

**Square shovel, metal ring handle**



Metal ring handle

See handles on page 203

| Code          | Dimensions mm | L mm | €            |   |
|---------------|---------------|------|--------------|---|
| <b>198615</b> | 280x340       | 1000 | <b>17,81</b> | 6 |

**Round point shovel, fiberglass handle**

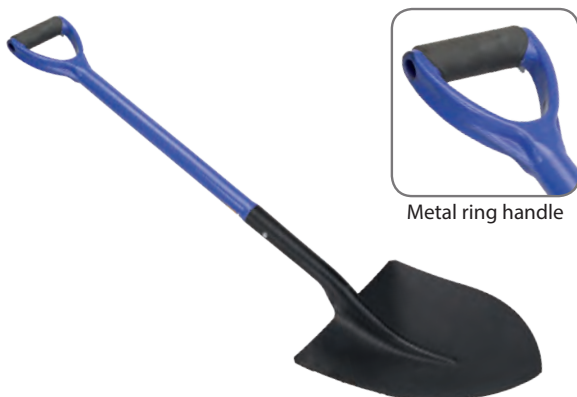

Metal ring handle

See handles on page 203

| Code          | Dimensions mm | L mm | €            |   |
|---------------|---------------|------|--------------|---|
| <b>198613</b> | 280x340       | 1000 | <b>22,50</b> | 6 |

**Square shovel, wooden handle**



Straight handle

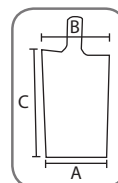

| Code          | Dimensions AxBxC mm | L mm | €            |   |
|---------------|---------------------|------|--------------|---|
| <b>198603</b> | 158x192x255         | 1220 | <b>13,32</b> | 6 |

## Mini round point shovel



Metal ring handle

**25 % SHORTER**

| Code          | Dimensions mm | L mm | €           |   |
|---------------|---------------|------|-------------|---|
| <b>198614</b> | 150x210       | 750  | <b>9,28</b> | 6 |

## Aluminium shovels



Ring handle

- Blade made of aluminium.
- Ring handle made of hard plastic.

| Code          | Dimensions mm | L mm | €            |   |
|---------------|---------------|------|--------------|---|
| <b>198617</b> | 245x300       | 1000 | <b>20,88</b> | 6 |

**Used for snow, foods...etc**



Ring handle

- Blade made in aluminium.
- Ring handle made of hard plastic.

| Code          | Dimensions mm | L mm | €            |   |
|---------------|---------------|------|--------------|---|
| <b>198619</b> | 360x415       | 1200 | <b>27,64</b> | 6 |

## Aluminium shovel with fiberglass handle



Ring handle

- Blade made of aluminium
- Ring handle made of fiberglass

| Code          | Dimensions mm | L mm | €            |   |
|---------------|---------------|------|--------------|---|
| <b>198621</b> | 360x415       | 1020 | <b>31,12</b> | 6 |

## Plastic shovel



Ring handle

- Blade made of aluminium
- Ring handle made of fiberglass

| Code          | Dimensions mm | L mm | €            |   |
|---------------|---------------|------|--------------|---|
| <b>198622</b> | 460x360       | 1250 | <b>19,90</b> | 6 |

**NEW**

**Handle for shovels**

| Image | Code          | For code                                     | Type   | L mm | €            |   |
|-------|---------------|--|--------|------|--------------|---|
|       | <b>198601</b> | 198600 / 198605                              | T grip | 700  | <b>4,97</b>  | 6 |
|       | <b>198611</b> | 198610 / 198615<br>198617                    | Ring   | 700  | <b>5,62</b>  | 6 |
|       | <b>198602</b> | 198600 / 198605                              | T grip | 815  | <b>9,94</b>  | 6 |
|       | <b>198612</b> | 198610 / 198615<br>198617 / 198613<br>198621 | Ring   | 735  | <b>10,48</b> | 6 |

**Half round hoe**



**CARBON STEEL**



• Welded hoe

| Code          | Dimensions mm | €            |    |
|---------------|---------------|--------------|----|
| <b>198500</b> | 260x160       | <b>13,49</b> | 12 |

**Rectangular hoe**



**CARBON STEEL**



| Code          | Dimensions mm | €            |    |
|---------------|---------------|--------------|----|
| <b>198502</b> | 310x138       | <b>13,64</b> | 12 |

**5 teeth forged rake**



**CARBON STEEL**



• Forged in Carbon Steel

| Code          | No. teeth | Dimensions mm | €            |   |
|---------------|-----------|---------------|--------------|---|
| <b>198505</b> | 5         | 200x160       | <b>17,26</b> | 6 |

**Handle for hoe and rake**



198501 / 198503 for hoes 198500 y 198502  
198506 / 198507 for rake 198505

| Code          | Type               | Ø mm | L mm | €            |   |
|---------------|--------------------|------|------|--------------|---|
| <b>198501</b> | <b>WOODEN</b>      | 38   | 1000 | <b>8,31</b>  | 6 |
| <b>198506</b> | <b>WOODEN</b>      | 34   | 1000 | <b>8,57</b>  | 6 |
| <b>198503</b> | <b>FIBER GLASS</b> | 32   | 1200 | <b>15,95</b> | 6 |
| <b>198507</b> | <b>FIBER GLASS</b> | 32   | 1000 | <b>14,50</b> | 6 |



## Rake

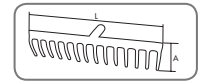

Handles at bottom of page

| Code          | No. teeth | A x L mm  | €           |   |
|---------------|-----------|-----------|-------------|---|
| <b>198512</b> | 12        | 100 x 410 | <b>7,39</b> | 6 |
| <b>198514</b> | 14        | 100 x 470 | <b>7,80</b> | 6 |
| <b>198516</b> | 16        | 100 x 530 | <b>8,22</b> | 6 |

## Garden fork

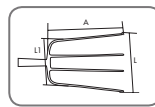

Handles at bottom of page

| Code          | No. teeth | A x L x L1 mm | €            |   |
|---------------|-----------|---------------|--------------|---|
| <b>198524</b> | 4         | 327x215x190   | <b>10,97</b> | 6 |
| <b>198525</b> | 5         | 337x217x195   | <b>14,79</b> | 6 |
| <b>198526</b> | 6         | 350x245x225   | <b>16,60</b> | 6 |

## Bended garden fork

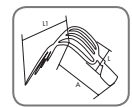

Handles at bottom of page

| Code          | No. teeth | A x L x L1 mm | €            |   |
|---------------|-----------|---------------|--------------|---|
| <b>198534</b> | 4         | 200x205x210   | <b>9,66</b>  | 6 |
| <b>198535</b> | 5         | 200x220x220   | <b>13,36</b> | 6 |

## Straight fork

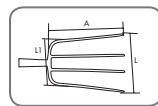

Handles at bottom of page

| Code          | No. teeth | A x L mm | €            |   |
|---------------|-----------|----------|--------------|---|
| <b>198544</b> | 4         | 280x175  | <b>12,89</b> | 6 |

## Straight fork for construction



Handles at bottom of page

| Code          | No. teeth | A x L mm | €            |   |
|---------------|-----------|----------|--------------|---|
| <b>198550</b> | 9         | 360x240  | <b>19,56</b> | 6 |

## Wooden handle for rakes and forks

| Image | Code          | For Code             | Type     | L mm | Ø mm | €           |   |
|-------|---------------|----------------------|----------|------|------|-------------|---|
|       | <b>198510</b> | 198512/198514/198516 | Straight | 1200 | 28   | <b>5,01</b> | 6 |
|       | <b>198527</b> | 198524/198525/198526 | Ring     | 900  | 38   | <b>6,97</b> | 6 |
|       | <b>198529</b> | 198524/198525/198526 | Straight | 1200 | 38   | <b>6,91</b> | 6 |
|       | <b>198538</b> | 198534/198535        | Ring     | 900  | 38   | <b>6,97</b> | 6 |
|       | <b>198539</b> | 198534/198535        | Straight | 1200 | 38   | <b>6,91</b> | 6 |
|       | <b>198548</b> | 198544               | Ring     | 900  | 38   | <b>6,97</b> | 6 |
|       | <b>198558</b> | 198550               | Ring     | 900  | 38   | <b>6,97</b> | 6 |

**Magnetic plumb bob**

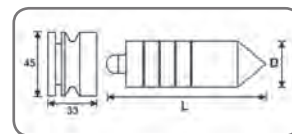

- Plumb bob manufactured in steel.
- Zinc coated finish to prevent rust.
- Plastic dolly with magnet
- 5 metre knotted nylon line

| Code          | Weight gr | L mm | Ø mm | €            |   |
|---------------|-----------|------|------|--------------|---|
| <b>197942</b> | 500       | 104  | 33   | <b>12,10</b> | 4 |
| <b>197944</b> | 750       | 134  | 33   | <b>14,20</b> | 4 |
| <b>197946</b> | 1000      | 162  | 33   | <b>16,00</b> | 4 |

Display with blister

**Wooden plumb bob**

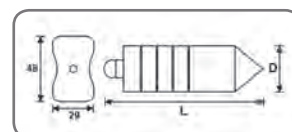

- Plumb bob manufactured in steel.
- Zinc coated finish to prevent rust.
- Wooden dolly
- 5 metre knotted nylon line

| Code          | Weight gr | L mm | Ø mm | €            |   |
|---------------|-----------|------|------|--------------|---|
| <b>197932</b> | 500       | 104  | 33   | <b>7,20</b>  | 4 |
| <b>197934</b> | 750       | 134  | 33   | <b>9,25</b>  | 4 |
| <b>197936</b> | 1000      | 162  | 33   | <b>12,10</b> | 4 |

Display with blister

**Magnetic angle**



- Angle with powerful magnets
- 10 metre Ø 1.2 mm knotted line
- Angle with rubber handle

**COMPOSITION**

- Pair of angles
- 10 metres of line

| Code          | €            |   |
|---------------|--------------|---|
| <b>197938</b> | <b>14,24</b> | 6 |

Display with blister

## One piece forged trowel

**BLADE AND TANG  
FORGED IN ONE PIECE**

- Lacquered blade to prevent rust
- Conically ground blade for good flexibility.
- Blade ground on both sides.
- Tempered blade and tang

## Bucket trowel



| WOODEN HANDLE |               |              |  |
|---------------|---------------|--------------|--|
| Code          | Dimensions mm | €            |  |
| <b>195900</b> | 180x115       | <b>15,70</b> | 6  |
| <b>195905</b> | 190x118       | <b>16,41</b> | 6  |



| BIMATERIAL HANDLE |               |              |  |
|-------------------|---------------|--------------|--|
| Code              | Dimensions mm | €            |  |
| <b>195901</b>     | 180x115       | <b>16,85</b> | 6  |
| <b>195906</b>     | 190x118       | <b>17,61</b> | 6  |

## Gauging trowel



| WOODEN HANDLE |               |              |  |
|---------------|---------------|--------------|--|
| Code          | Dimensions mm | €            |  |
| <b>195910</b> | 190x104       | <b>13,62</b> | 6  |
| <b>195915</b> | 215x116       | <b>14,29</b> | 6  |



| BIMATERIAL HANDLE |               |              |  |
|-------------------|---------------|--------------|--|
| Code              | Dimensions mm | €            |  |
| <b>195911</b>     | 190x104       | <b>15,26</b> | 6  |
| <b>195916</b>     | 215x116       | <b>15,84</b> | 6  |

## Catalano pattern trowel



| WOODEN HANDLE |               |              |  |
|---------------|---------------|--------------|--|
| Code          | Dimensions mm | €            |  |
| <b>195920</b> | 150x115       | <b>15,42</b> | 6  |
| <b>195925</b> | 160x120       | <b>16,15</b> | 6  |



| BIMATERIAL HANDLE |               |              |  |
|-------------------|---------------|--------------|--|
| Code              | Dimensions mm | €            |  |
| <b>195921</b>     | 150x115       | <b>17,04</b> | 6  |
| <b>195926</b>     | 160x120       | <b>17,70</b> | 6  |

## Seville pattern trowel



| WOODEN HANDLE |               |              |  |
|---------------|---------------|--------------|--|
| Code          | Dimensions mm | €            |  |
| <b>195930</b> | 190x115       | <b>16,50</b> | 6  |



| BIMATERIAL HANDLE |               |              |  |
|-------------------|---------------|--------------|--|
| Code              | Dimensions mm | €            |  |
| <b>195931</b>     | 190x115       | <b>17,96</b> | 6  |

**Welded trowel**

**BLADE AND TANG  
WELDED JOINT**

- Lacquered blade to prevent rust
- Conically ground blade for good flexibility.
- Blade ground on both sides.
- Tempered blade and tang

**Bucket trowel**



| WOODEN HANDLE |               |             |    |
|---------------|---------------|-------------|----|
| Code          | Dimensions mm | €           |    |
| <b>195700</b> | 180x115x87    | <b>7,76</b> | 12 |
| <b>195705</b> | 190x118x90    | <b>8,39</b> | 12 |

| BIMATERIAL HANDLE |               |             |    |
|-------------------|---------------|-------------|----|
| Code              | Dimensions mm | €           |    |
| <b>195701</b>     | 180x115x87    | <b>9,35</b> | 12 |
| <b>195706</b>     | 190x118x90    | <b>9,82</b> | 12 |



**Gauging trowel**



| WOODEN HANDLE |               |             |    |
|---------------|---------------|-------------|----|
| Code          | Dimensions mm | €           |    |
| <b>195708</b> | 140x80        | <b>5,51</b> | 12 |
| <b>195710</b> | 178x98        | <b>6,73</b> | 12 |
| <b>195715</b> | 200x110       | <b>7,04</b> | 12 |
| <b>195717</b> | 220x125       | <b>7,50</b> | 12 |

| BIMATERIAL HANDLE |               |             |    |
|-------------------|---------------|-------------|----|
| Code              | Dimensions mm | €           |    |
| <b>195709</b>     | 140x80        | <b>7,19</b> | 12 |
| <b>195711</b>     | 178x98        | <b>8,51</b> | 12 |
| <b>195716</b>     | 200x110       | <b>8,85</b> | 12 |
| <b>195718</b>     | 220x125       | <b>9,30</b> | 12 |



**Catalano pattern trowel**



| WOODEN HANDLE |               |             |    |
|---------------|---------------|-------------|----|
| Code          | Dimensions mm | €           |    |
| <b>195720</b> | 155x115       | <b>7,74</b> | 12 |
| <b>195725</b> | 170x120       | <b>7,90</b> | 12 |
| <b>195723</b> | 180x125       | <b>8,17</b> | 12 |

| BIMATERIAL HANDLE |               |             |    |
|-------------------|---------------|-------------|----|
| Code              | Dimensions mm | €           |    |
| <b>195721</b>     | 155x115       | <b>8,81</b> | 12 |
| <b>195726</b>     | 170x120       | <b>8,97</b> | 12 |
| <b>195724</b>     | 180x125       | <b>9,30</b> | 12 |



## Seville pattern trowel



| WOODEN HANDLE |               |             |    |
|---------------|---------------|-------------|----|
| Code          | Dimensions mm | €           |    |
| <b>195730</b> | 190x115x90    | <b>8,11</b> | 12 |

| BIMATERIAL HANDLE |               |             |    |
|-------------------|---------------|-------------|----|
| Code              | Dimensions mm | €           |    |
| <b>195731</b>     | 190x115x90    | <b>9,37</b> | 12 |



## Pointed mini trowel



| WOODEN HANDLE |               |             |    |
|---------------|---------------|-------------|----|
| Code          | Dimensions mm | €           |    |
| <b>195740</b> | 130x75        | <b>5,65</b> | 12 |

| MANGO BIMATERIAL |               |             |    |
|------------------|---------------|-------------|----|
| Code             | Dimensions mm | €           |    |
| <b>195741</b>    | 130x75        | <b>7,41</b> | 12 |



## Rounded tip mini trowel



| WOODEN HANDLE |               |             |    |
|---------------|---------------|-------------|----|
| Code          | Dimensions mm | €           |    |
| <b>195750</b> | 125x70        | <b>5,51</b> | 12 |

| BIMATERIAL HANDLE |               |             |    |
|-------------------|---------------|-------------|----|
| Code              | Dimensions mm | €           |    |
| <b>195751</b>     | 125x70        | <b>7,31</b> | 12 |



## Olive leaf mini-trowel



| WOODEN HANDLE |               |             |    |
|---------------|---------------|-------------|----|
| Code          | Dimensions mm | €           |    |
| <b>195760</b> | 130x70        | <b>5,27</b> | 12 |

| BIMATERIAL HANDLE |               |             |    |
|-------------------|---------------|-------------|----|
| Code              | Dimensions mm | €           |    |
| <b>195761</b>     | 130x70        | <b>7,02</b> | 12 |



## Trowel for board, wooden handle



| Code          | L mm | C mm | €           |    |
|---------------|------|------|-------------|----|
| <b>195804</b> | 180  | 8    | <b>3,20</b> | 12 |
| <b>195806</b> | 180  | 10   | <b>3,30</b> | 12 |

**Plastering trowe, bimaterial handle**

STAINLESS  
STEEL



Smooth base without screws

| Code          | Dimensions mm | €            |   |
|---------------|---------------|--------------|---|
| <b>195772</b> | 280x215       | <b>11,12</b> | 6 |

**Plastering trowel**

STAINLESS  
STEEL



Smooth base without screws

| Code          | Dimensions mm | €            |   |
|---------------|---------------|--------------|---|
| <b>195770</b> | 300x150       | <b>10,76</b> | 6 |

**Rectangular plastering trowel sharp edge**

STAINLESS  
STEEL



Sharp edges



Smooth base

| Code          | Dimensions mm | €            |   |
|---------------|---------------|--------------|---|
| <b>195768</b> | 300x150       | <b>11,96</b> | 6 |

**Plastering trapezoidal trowel**

STAINLESS  
STEEL



Smooth base

| Code          | Dimensions mm | €            |   |
|---------------|---------------|--------------|---|
| <b>195780</b> | 300x140-150   | <b>10,76</b> | 6 |

**Serrated plastering trowel**

STAINLESS  
STEEL



| Code          | Dimensions mm | pitch | €            |    |
|---------------|---------------|-------|--------------|----|
| <b>195785</b> | 280x120       | 6x6   | <b>11,07</b> | 10 |
| <b>195786</b> | 280x120       | 8x8   | <b>11,65</b> | 10 |
| <b>195787</b> | 280x120       | 10x10 | <b>12,22</b> | 10 |

**Half moon plastering trowel**

STAINLESS  
STEEL



| Code          | Dimensions mm | €            |   |
|---------------|---------------|--------------|---|
| <b>195774</b> | 300x150       | <b>10,76</b> | 6 |

## Long plastering trowel

STAINLESS  
STEEL





| Code          | Dimensions mm | €            |  |
|---------------|---------------|--------------|---|
| <b>195775</b> | 500x130       | <b>14,03</b> | 6   |

## Serrated long plastering trowel

STAINLESS  
STEEL



| Code          | Dimensions mm |  pitch | €            |  |
|---------------|---------------|---|--------------|---|
| <b>195776</b> | 500x130       | 8x8   | <b>15,28</b> | 6   |

## Plastering trowel monolayer

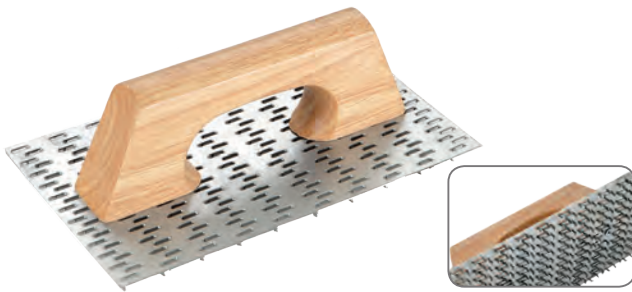

| Code          | Dimensions mm | €            |  |
|---------------|---------------|--------------|---|
| <b>195762</b> | 250x140       | <b>13,67</b> | 6   |

## Aluminium trowel



| Code          | Dimensions mm | €            |  |
|---------------|---------------|--------------|---|
| <b>195764</b> | 450x80        | <b>21,62</b> | 6   |

## Plastic rectangular float



• Base made of polystyrene

| Code          | Dimensions mm | €           |  |
|---------------|---------------|-------------|---|
| <b>195790</b> | 270x180       | <b>2,80</b> | 6   |

## Plastic pointed-tipped float



• Base made of polystyrene

| Code          | Dimensions mm | €           |  |
|---------------|---------------|-------------|---|
| <b>195792</b> | 270x180       | <b>2,82</b> | 6   |

## Float for joints



## Special for work on joints



• Handle made of polyurethane  
• Base with aluminium reinforcement

| Code          | Dimensions mm | €           |  |
|---------------|---------------|-------------|---|
| <b>195800</b> | 240x100       | <b>8,63</b> | 6   |

**Soft rubber sponge face float**



- 20 mm thick base
- Handle and base made of polyurethane

| Code          | Dimensions mm | €           |   |
|---------------|---------------|-------------|---|
| <b>195795</b> | 280x140       | <b>6,60</b> | 6 |

**Soft rubber sponge face float high density**

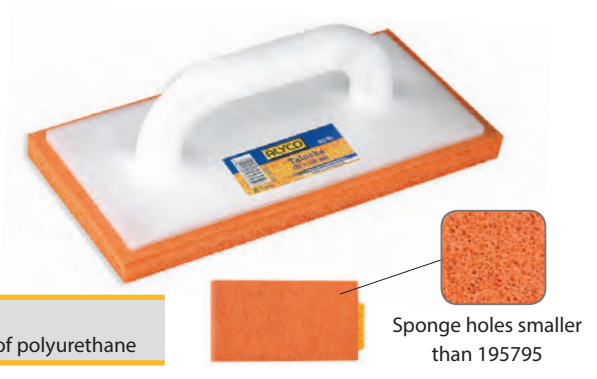

| Code          | Dimensions mm | €           |   |
|---------------|---------------|-------------|---|
| <b>195796</b> | 280x140       | <b>6,75</b> | 6 |

**Soft rubber sponge face float low density**



| Code          | Dimensions mm | €           |   |
|---------------|---------------|-------------|---|
| <b>195788</b> | 240x140       | <b>5,50</b> | 6 |

**Filler knife, tricomponent handle**

**STAINLESS STEEL**

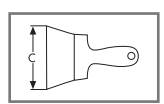

| Code          | C mm | €           |   |
|---------------|------|-------------|---|
| <b>196306</b> | 120  | <b>6,01</b> | 6 |
| <b>196311</b> | 140  | <b>6,20</b> | 6 |
| <b>196316</b> | 160  | <b>6,62</b> | 6 |
| <b>196318</b> | 180  | <b>7,22</b> | 6 |
| <b>196321</b> | 200  | <b>8,69</b> | 6 |

**Filler knife**

**STAINLESS STEEL**

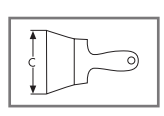

| Code          | C mm | €           |    |
|---------------|------|-------------|----|
| <b>196305</b> | 120  | <b>3,72</b> | 12 |
| <b>196310</b> | 140  | <b>4,18</b> | 12 |
| <b>196315</b> | 160  | <b>4,96</b> | 12 |
| <b>196320</b> | 200  | <b>5,79</b> | 12 |

**Car repair scraper kit**

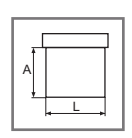

**CONTENTS**  
 1 Scraper of L: 50 A: 90  
 1 Scraper of L: 75 A: 90  
 1 Scraper of L: 100 A: 90  
 1 Scraper of L: 120 A: 95

| Code          | No. of items | €           |    |
|---------------|--------------|-------------|----|
| <b>196322</b> | 4            | <b>4,82</b> | 12 |

## Stainless steel scraper

STAINLESS  
STEEL



Metal reinforcement for striking

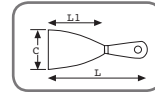

- Conically ground blade for better tip flexibility
- Handle core made of high strength plastic
- Handle covered in rubber antislip material

| Code          | C mm | L mm | €           |    |
|---------------|------|------|-------------|----|
| <b>196399</b> | 30   | 210  | <b>3,43</b> | 12 |
| <b>196401</b> | 40   | 220  | <b>3,47</b> | 12 |
| <b>196403</b> | 50   | 220  | <b>3,64</b> | 12 |
| <b>196406</b> | 60   | 220  | <b>3,81</b> | 12 |
| <b>196411</b> | 80   | 220  | <b>4,42</b> | 12 |
| <b>196416</b> | 100  | 220  | <b>4,87</b> | 12 |
| <b>196421</b> | 120  | 230  | <b>5,60</b> | 12 |
| <b>196423</b> | 150  | 230  | <b>6,72</b> | 12 |

## Scraper with wooden handle

CARBON  
STEEL

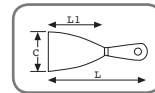

| Code          | C mm | L mm | €           |    |
|---------------|------|------|-------------|----|
| <b>196325</b> | 25   | 180  | <b>2,53</b> | 12 |
| <b>196340</b> | 40   | 190  | <b>2,63</b> | 12 |
| <b>196350</b> | 50   | 195  | <b>2,73</b> | 12 |
| <b>196360</b> | 60   | 205  | <b>2,78</b> | 12 |
| <b>196375</b> | 75   | 215  | <b>3,05</b> | 12 |
| <b>196385</b> | 85   | 220  | <b>3,30</b> | 12 |
| <b>196390</b> | 100  | 225  | <b>3,55</b> | 12 |
| <b>196395</b> | 120  | 230  | <b>3,77</b> | 12 |

## Scraper with bimaterial handle

CARBON  
STEEL



- Conically ground blade for better tip flexibility
- Inner part in heavy duty plastic
- Soft rubber in hand contact area

| Code          | C mm | L mm | €           |    |
|---------------|------|------|-------------|----|
| <b>196430</b> | 30   | 210  | <b>2,80</b> | 12 |
| <b>196440</b> | 40   | 210  | <b>2,91</b> | 12 |
| <b>196450</b> | 50   | 210  | <b>3,08</b> | 12 |
| <b>196460</b> | 60   | 210  | <b>3,25</b> | 12 |
| <b>196480</b> | 80   | 210  | <b>3,58</b> | 12 |
| <b>196490</b> | 100  | 220  | <b>3,97</b> | 12 |
| <b>196495</b> | 120  | 220  | <b>4,25</b> | 12 |
| <b>196496</b> | 150  | 235  | <b>5,20</b> | 12 |

## Scrapers displayer

**CONTENTS** 196401 (12), 196406(12), 196411 (12), 196416 (12), 196421 (12)

### STAINLESS STEEL SCRAPERS DISPLAYER

| Code          | No. of items | €             |   |
|---------------|--------------|---------------|---|
| <b>196422</b> | 60           | <b>265,19</b> | 1 |



**CONTENTS** 196440 (12), 196460(12), 196480 (12), 196490 (12), 196495 (12)

### BIMATERIAL HANDLE SCRAPERS DISPLAYER

| Code          | No. of items | €             |   |
|---------------|--------------|---------------|---|
| <b>196499</b> | 60           | <b>215,71</b> | 1 |

**Wrecking bar**

**CARBON  
STEEL**

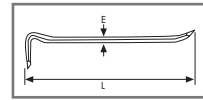
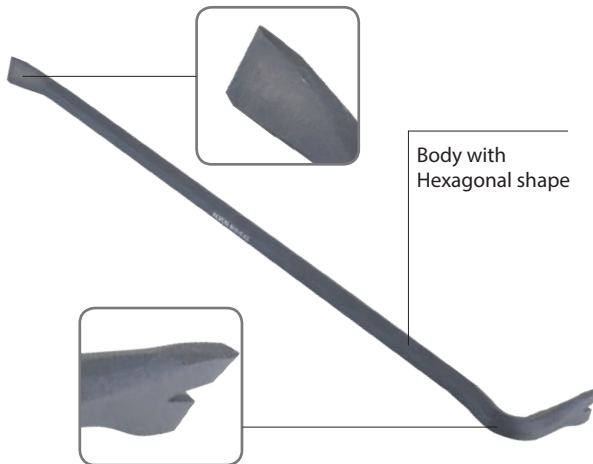

- Induction hardened tips
- Painted finish.

| Code          | L mm | L " | E mm | €            |   |
|---------------|------|-----|------|--------------|---|
| <b>118001</b> | 500  | 20  | 20   | <b>11,33</b> | 6 |
| <b>118002</b> | 600  | 24  | 20   | <b>14,97</b> | 6 |
| <b>118003</b> | 700  | 28  | 20   | <b>17,02</b> | 6 |
| <b>118004</b> | 800  | 32  | 22   | <b>18,23</b> | 5 |
| <b>118005</b> | 900  | 36  | 22   | <b>22,40</b> | 5 |
| <b>118006</b> | 1000 | 40  | 22   | <b>24,08</b> | 5 |
| <b>118007</b> | 1200 | 48  | 22   | <b>27,44</b> | 5 |

**Light wrecking bar**



- Chrome-plated finishing coated
- Induction hardened tips

| Code          | L mm | L " | €            |   |
|---------------|------|-----|--------------|---|
| <b>118010</b> | 300  | 12  | <b>10,18</b> | 2 |

**Mason's pin**



| Code          | L mm | E mm | €           |   |
|---------------|------|------|-------------|---|
| <b>196942</b> | 250  | 10   | <b>4,32</b> | 6 |
| <b>196945</b> | 300  | 10   | <b>4,56</b> | 6 |

**Reversible ratcheting podger wrench**

**Cr-V  
STEEL**

**19x22**



**Special for scaffold  
assembling and  
disassembling**

| Code          | mm    | €            |   |
|---------------|-------|--------------|---|
| <b>191900</b> | 19x22 | <b>56,00</b> | 2 |

## T handle screw clamp (90 mm)

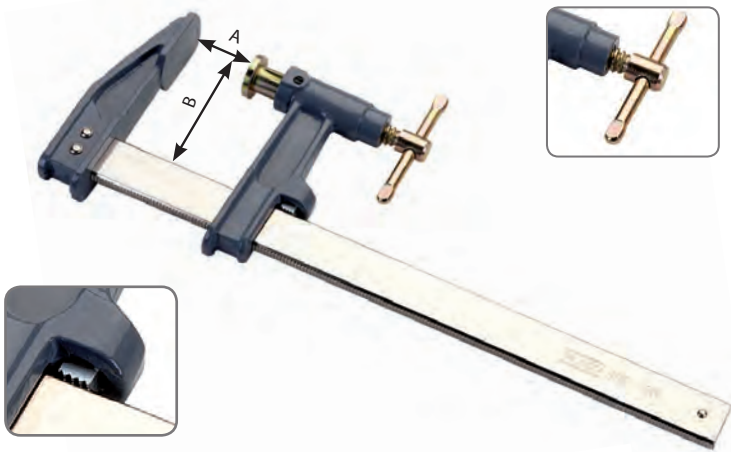

- Painted nodular cast iron jaws
- Bar and jaw fastening reinforced with double steel rivet for safety
- Calibrated steel bar with teeth on both sides
- Tempered brake with teeth
- One piece spindle and pad
- Trapezoidal double thread spindle for high torques

| Code          | A mm | B mm | Bar mm | €            |   |
|---------------|------|------|--------|--------------|---|
| <b>197800</b> | 200  | 90   | 28x8   | <b>12,90</b> | 6 |
| <b>197805</b> | 300  | 90   | 28x8   | <b>13,78</b> | 6 |
| <b>197810</b> | 400  | 90   | 28x8   | <b>16,03</b> | 6 |

## T handle screw clamp (120-150 mm)

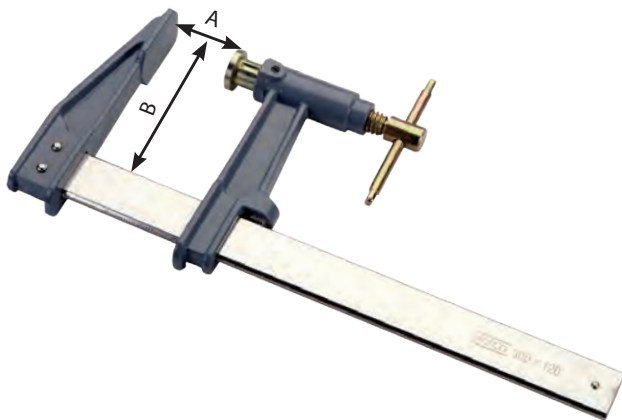

- The same features as screw clamp code 197800

| Code          | A mm | B mm | Bar mm | €            |   |
|---------------|------|------|--------|--------------|---|
| <b>197850</b> | 300  | 120  | 35x8   | <b>15,83</b> | 6 |
| <b>197855</b> | 400  | 120  | 35x8   | <b>18,16</b> | 6 |
| <b>197860</b> | 600  | 120  | 35x8   | <b>20,21</b> | 4 |
| <b>197865</b> | 800  | 120  | 35x8   | <b>22,67</b> | 4 |
| <b>197870</b> | 1000 | 120  | 35x8   | <b>24,64</b> | 2 |
| <b>197872</b> | 1200 | 120  | 35x8   | <b>27,38</b> | 2 |
| <b>197873</b> | 1400 | 120  | 35x8   | <b>32,95</b> | 2 |
| <b>197875</b> | 400  | 150  | 40x10  | <b>24,14</b> | 2 |
| <b>197877</b> | 600  | 150  | 40x10  | <b>27,25</b> | 2 |
| <b>197880</b> | 800  | 150  | 40x10  | <b>31,29</b> | 2 |
| <b>197882</b> | 1000 | 150  | 40x10  | <b>33,94</b> | 2 |

## Screw clamp with bimaterial handle

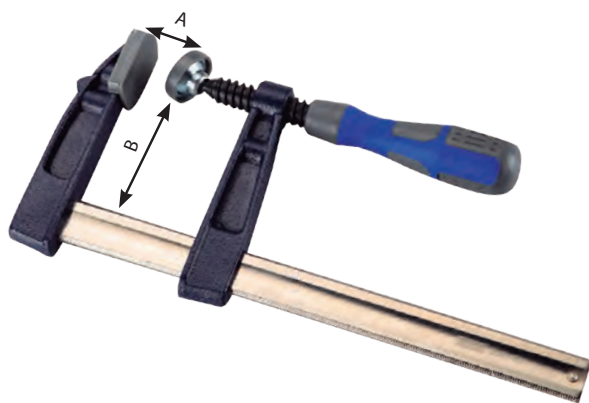

- Calibrated steel bar with teeth on both sides.
- Nodular cast iron painted jaws
- Bimaterial and ergonomic plastic handle
- Trapezoidal thread screw
- Jaws with plastic protectors

| Code          | A mm | B mm | Bar mm | €            |   |
|---------------|------|------|--------|--------------|---|
| <b>197900</b> | 100  | 50   | 5x15   | <b>4,36</b>  | 6 |
| <b>197905</b> | 150  | 50   | 5x15   | <b>4,56</b>  | 6 |
| <b>197910</b> | 200  | 80   | 6x22   | <b>7,72</b>  | 6 |
| <b>197915</b> | 300  | 80   | 6x22   | <b>8,35</b>  | 6 |
| <b>197920</b> | 400  | 100  | 7x22   | <b>10,36</b> | 6 |

## Forged "C" screw clamp

**FORGED  
STEEL**

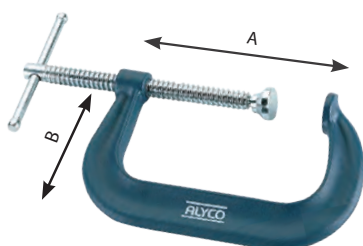

| Code          | A mm | B mm | €            |   |
|---------------|------|------|--------------|---|
| <b>197950</b> | 50   | 55   | <b>16,43</b> | 4 |
| <b>197955</b> | 75   | 55   | <b>20,87</b> | 4 |
| <b>197960</b> | 100  | 55   | <b>26,13</b> | 4 |
| <b>197965</b> | 150  | 55   | <b>42,17</b> | 4 |

## Quick plastic clamp



- Quick release lever. Ratchet action trigger.
- Jaws reinforced with soft rubber protectors.
- Ergonomic design. Bimaterial handles.

| Code          | Tightening mm / " | Opening mm | €            |   |
|---------------|-------------------|------------|--------------|---|
| <b>198050</b> | 150 / 6           | 350        | <b>13,01</b> | 6 |
| <b>198052</b> | 300 / 12          | 500        | <b>13,61</b> | 6 |
| <b>198054</b> | 450 / 18          | 640        | <b>15,38</b> | 6 |

## Plastic clamps with ratchet system



- Ratchet made in zinc alloy.
- Special design of jaws to tighten irregular shape pieces.
- Long and thin jaws to get to confined places.

| Code          | L mm | Tightening force kg. | €           |    |
|---------------|------|----------------------|-------------|----|
| <b>198070</b> | 135  | 13                   | <b>2,89</b> | 12 |
| <b>198072</b> | 190  | 30                   | <b>4,89</b> | 12 |
| <b>198074</b> | 250  | 43                   | <b>7,13</b> | 12 |

## Plastic spring clamps



- Inner spring to get easier and quicker opening
- Protected jaws so not to damage pieces and to allow tightening of irregular shapes.

| Code          | L mm / " | Opening mm | Tightening kg | €           |    |
|---------------|----------|------------|---------------|-------------|----|
| <b>197970</b> | 75 / 3   | 35         | 3,5           | <b>0,91</b> | 12 |
| <b>197972</b> | 100 / 4  | 40         | 7,2           | <b>1,31</b> | 12 |
| <b>197975</b> | 150 / 6  | 62         | 13            | <b>1,80</b> | 12 |
| <b>197976</b> | 225 / 9  | 82         | 22            | <b>2,63</b> | 12 |

## Metal spring clamps



- Inner spring to get easier and quicker opening jaws and handles covered with PVC

| Code          | L mm / " | Opening mm | Tightening kg | €           |   |
|---------------|----------|------------|---------------|-------------|---|
| <b>197982</b> | 50 / 2   | 17         | 10            | <b>1,17</b> | 6 |
| <b>197985</b> | 100 / 4  | 22         | 10            | <b>2,06</b> | 6 |
| <b>197986</b> | 150 / 6  | 45         | 10            | <b>3,57</b> | 6 |
| <b>197987</b> | 225 / 9  | 75         | 10            | <b>5,35</b> | 6 |

## Clamp displayer



Back view

### CONTENTS

#### T SCREW CLAMPS

- 197800 (6), 197805 (6), 197810 (6), 197850 (6)
- 197855 (6), 197860 (4), 197865 (4), 197870 (2)
- 197877 (2), 197880 (2), 197882 (2), 197900 (6)
- 197905 (6), 197910 (6), 197915 (6), 197920 (6)

#### QUICK PLASTIC CLAMPS

- 198050 (6), 198052 (6), 198054 (6)

#### SPRING CLAMPS

- 197972 (12), 197975 (6), 197985 (12), 197986 (6)

| Code          | No. of items | €               |   |
|---------------|--------------|-----------------|---|
| <b>197988</b> | 130          | <b>1.395,50</b> | 1 |



## Nylon construction bag



Dimensions: 370x310x130 mm

- Made of nylon with inner reinforcements
- Adjustable nylon belt
- Close quick

| Code          | €            |   |
|---------------|--------------|---|
| <b>196872</b> | <b>22,20</b> | 1 |

Display in bag with hanger

## Double nylon pouch with belt



- Manufactured with reinforced seams
- Adjustable belt with click shut buckle

| Code          | AxB mm  | €            |   |
|---------------|---------|--------------|---|
| <b>196870</b> | 660x260 | <b>13,40</b> | 1 |

Display in bag with hanger

## Individual nylon pouch with belt



- Manufactured with reinforced seams
- Adjustable belt with click shut buckle

| Code          | AxB mm  | €           |   |
|---------------|---------|-------------|---|
| <b>196875</b> | 260x260 | <b>9,05</b> | 1 |

Display in bag with hanger

## Double leather pouch with belt



- Made in high quality strong leather
- Reinforced seams and metal rivets over the entire bag
- Adjustable nylon belt
- Metal clip for tape measure
- Large-sized pocket for nails
- 2 loops for hammers

| Code          | AxB mm  | €            |   |
|---------------|---------|--------------|---|
| <b>196890</b> | 660x210 | <b>21,00</b> | 1 |

Display in bag with hanger

**Individual leather pouch with belt**



- Made in high quality strong leather
- Reinforced seams and metal rivets over the entire bag
- Adjustable nylon belt
- Metal clip for tape measure
- Large-sized pocket for nails

| Code          | AxB mm  | €            |   |
|---------------|---------|--------------|---|
| <b>196894</b> | 230x210 | <b>14,40</b> | 1 |

**Display in bag with hanger**

**Individual leather pouch**



- Made in high quality strong leather
- Reinforced seams and metal rivets over the entire bag
- Large sized pocket for nails
- 2 loops for hammers

| Code          | AxB mm  | €            |   |
|---------------|---------|--------------|---|
| <b>196895</b> | 260x290 | <b>14,20</b> | 1 |

**Display in bag with hanger**

**Tape measure holder**



- Slots suitable for belts
- Suitable for 3 and 5 meter steel tape measures.
- Reinforced with metal rivets.

| Code          | Type    | AxB mm  | €           |   |
|---------------|---------|---------|-------------|---|
| <b>196898</b> | Leather | 110x160 | <b>4,42</b> | 6 |
| <b>196899</b> | Nylon   | 110x160 | <b>5,80</b> | 6 |

**Display in bag with hanger**

**Hammer loop**



- Slots suitable for belts
- Metal ring for holding the hammer
- Metal ring reinforced with metal rivets

| Code          | Type    | AxB mm  | €           |   |
|---------------|---------|---------|-------------|---|
| <b>196896</b> | Leather | 200x120 | <b>3,57</b> | 6 |
| <b>196886</b> | Nylon   | 200x120 | <b>3,82</b> | 6 |

**Display in bag with hanger**

**Belt**



- High quality leather belt with metal buckle. (196885)
- Adjustable nylon belt with metal buckle. (196897)

| Code          | Type    | L mm | €            |   |
|---------------|---------|------|--------------|---|
| <b>196885</b> | Leather | 1240 | <b>11,90</b> | 6 |
| <b>196897</b> | Nylon   | 1240 | <b>2,99</b>  | 6 |

**Display in bag with hanger**



## 12 Plumbing and measuring



Pipe wrench 220



Chain wrench 220



Strap wrench 221



PVC pipe cutter 222



Pipe cutter 223



Iron pipe cutter 225



Level 226

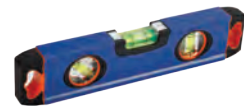

Torpedo level 228



Tape measure 229



Long tape measure 230



Measuring wheel 230



Chalk line reel 231



Square 232



Caliper and gauge 233



Marking tool 234



Marker 235



**Reinforced Stillson wrench**

**FORGED  
STEEL**

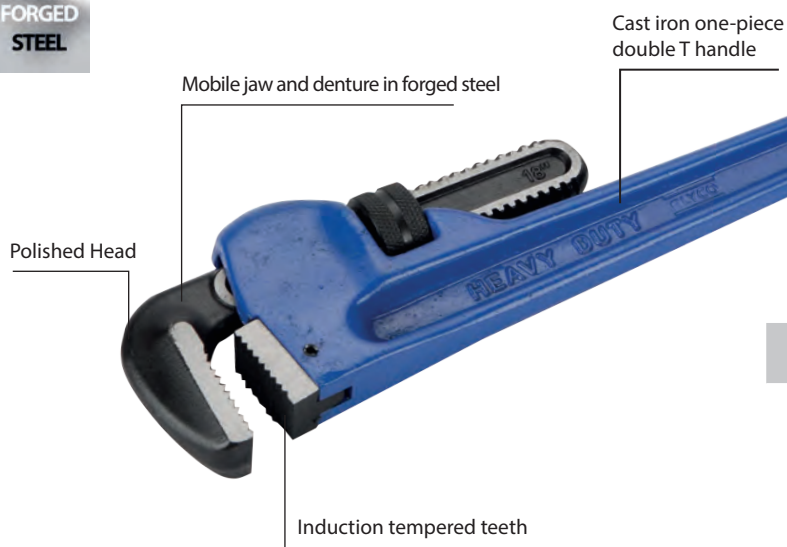

**REINFORCED MODEL  
LIGHTER**

| Code          | L<br>" | L<br>mm | ⌀<br>max " | €            |   |
|---------------|--------|---------|------------|--------------|---|
| <b>111212</b> | 12     | 300     | 1-1/4"     | <b>17,65</b> | 1 |
| <b>111214</b> | 14     | 350     | 1-1/2"     | <b>21,31</b> | 1 |
| <b>111218</b> | 18     | 450     | 2"         | <b>28,94</b> | 1 |
| <b>111224</b> | 24     | 600     | 2-1/2"     | <b>49,70</b> | 1 |
| <b>111236</b> | 36     | 900     | 3-1/2"     | <b>96,20</b> | 1 |

**Drop-forged Stillson pipe wrench**

**FORGED  
STEEL**



- Mobile jaw hardened to 45 HRC
- Very heavy duty tool with teeth hardened to 60 HRC
- Painted finish handle

| Code          | L<br>" | L<br>mm | ⌀<br>max " | €            |   |
|---------------|--------|---------|------------|--------------|---|
| <b>111308</b> | 8      | 200     | 3/4"       | <b>12,02</b> | 1 |
| <b>111310</b> | 10     | 250     | 1"         | <b>14,75</b> | 1 |
| <b>111312</b> | 12     | 300     | 1-1/4"     | <b>17,13</b> | 1 |
| <b>111314</b> | 14     | 350     | 1-1/2"     | <b>20,69</b> | 1 |
| <b>111318</b> | 18     | 450     | 2"         | <b>28,11</b> | 1 |
| <b>111324</b> | 24     | 600     | 2-1/2"     | <b>48,26</b> | 1 |
| <b>111336</b> | 36     | 900     | 3-1/2"     | <b>93,40</b> | 1 |

**Light Aluminium alloy Stillson pipe wrench**

**ALUMINIUM**



- Special profile of the handle that gives resistance and lightness to the wrench
- Tempered 45 HRC head, polished
- Induction tempered teeth at 60 HRC
- Presentation of body and handle painted

| Code          | L<br>" | L<br>mm | ⌀<br>max " | €             |   |
|---------------|--------|---------|------------|---------------|---|
| <b>111410</b> | 10     | 250     | 1-1/2"     | <b>15,38</b>  | 1 |
| <b>111412</b> | 12     | 300     | 1-3/4"     | <b>20,28</b>  | 1 |
| <b>111414</b> | 14     | 350     | 2"         | <b>24,83</b>  | 1 |
| <b>111418</b> | 18     | 450     | 2-1/2"     | <b>33,85</b>  | 1 |
| <b>111424</b> | 24     | 600     | 3"         | <b>57,99</b>  | 1 |
| <b>111436</b> | 36     | 900     | 4"         | <b>112,21</b> | 1 |

## Swedish type pipe wrench

**FORGED  
STEEL**



- Head hardened to 45 HRC
- Very heavy duty tool with teeth hardened to 60 HRC
- Body finish painted

| Code          | L<br>mm | Max.cap.<br>mm / " | €            |   |
|---------------|---------|--------------------|--------------|---|
| <b>111375</b> | 320     | 25/1               | <b>19,66</b> | 1 |
| <b>111380</b> | 425     | 40/1-1/2           | <b>26,78</b> | 1 |
| <b>111385</b> | 550     | 50/2               | <b>41,76</b> | 1 |
| <b>111390</b> | 630     | 75/3               | <b>63,01</b> | 1 |

## Straight angle pipe wrench

**FORGED  
STEEL**



- Head hardened to 45 HRC
- Very heavy duty tool with teeth hardened to 60 HRC
- Body finish painted

| Code          | L<br>mm | Max.cap.<br>mm / " | €            |   |
|---------------|---------|--------------------|--------------|---|
| <b>111355</b> | 320     | 25/1               | <b>18,42</b> | 1 |
| <b>111360</b> | 425     | 40/1-1/2           | <b>25,05</b> | 1 |
| <b>111365</b> | 550     | 50/2               | <b>39,05</b> | 1 |
| <b>111370</b> | 630     | 75/3               | <b>58,96</b> | 1 |

## Forged chain pipe wrench

**FORGED  
STEEL**

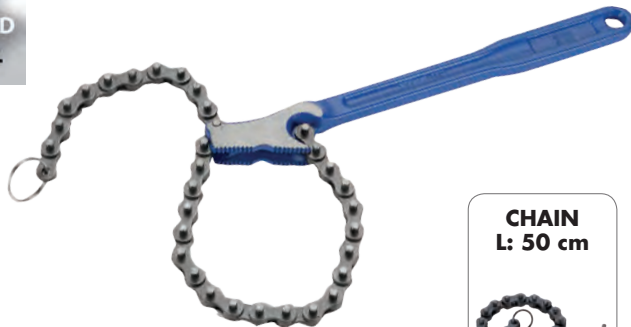

**CHAIN  
L: 50 cm**



- Body tempered to 40 HRC
- Very heavy duty tool with teeth hardened to 52 HRC
- Body finish painted
- With hole for hanging

| Code               | L<br>" | L<br>mm         | max<br>" | €            |   |
|--------------------|--------|-----------------|----------|--------------|---|
| <b>111340</b>      | 12     | 300             | 130      | <b>28,50</b> | 1 |
| <b>SPARE CHAIN</b> |        |                 |          |              |   |
| <b>111341</b>      | 20     | for code 111340 |          | <b>11,39</b> | 1 |

## Forged chain pipe wrench

**FORGED  
STEEL**



**CHAIN  
L: 62,5 cm**



- Body tempered to 40 HRC
- Very heavy duty tool with teeth hardened to 52 HRC
- Body finish painted
- With hole for hanging

| Code               | L<br>" | L<br>mm         | max<br>" | €            |   |
|--------------------|--------|-----------------|----------|--------------|---|
| <b>111342</b>      | 18     | 450             | 160      | <b>48,42</b> | 1 |
| <b>SPARE CHAIN</b> |        |                 |          |              |   |
| <b>111343</b>      | 25     | for code 111342 |          | <b>19,36</b> | 1 |

**Forged chain pipe wrench longue**

**FORGED  
STEEL**



**CHAIN**  
**111350**  
**L: 73 cm**  
**111352**  
**L: 85 cm**



- Body tempered to 40 HRC
- Very heavy duty tool with teeth hardened to 52 HRC
- Body finish painted
- With hole for hanging

| Code          | L<br>" | L<br>mm | L chain<br>mm/" | Ø<br>max " | €             |   |
|---------------|--------|---------|-----------------|------------|---------------|---|
| <b>111350</b> | 24     | 600     | 730/29          | 7          | <b>75,97</b>  | 1 |
| <b>111352</b> | 36     | 900     | 850/34          | 8          | <b>143,00</b> | 1 |

**Forged pipe wrench for strong works**

**FORGED  
STEEL**

**Used in oil pipelines,  
gas pipelines and perforations**



**CHAIN**  
**111344**  
**L: 67 cm**  
**111346**  
**L: 82 cm**



- Forged handle
- Induction tempered teeth
- Head with reversible jaw
- Metallic chain in steel

| Code          | L<br>"          | L<br>mm | L chain<br>mm/" | Ø<br>max " | €             |   |
|---------------|-----------------|---------|-----------------|------------|---------------|---|
| <b>111344</b> | 36              | 900     | 675/27          | 4          | <b>92,60</b>  | 1 |
| <b>111346</b> | 40              | 1000    | 825/33          | 6          | <b>127,65</b> | 1 |
| SPARE CHAIN   |                 |         |                 |            |               |   |
| <b>111345</b> | for code 111344 |         |                 |            | <b>37,04</b>  | 1 |
| <b>111347</b> | for code 111346 |         |                 |            | <b>50,67</b>  | 1 |

**Oil filter wrench**

**FORGED  
STEEL**



**STRAP**  
**L: 53 cm**

**Used in oil filter  
changes**

| Code          | L<br>" | L<br>mm | L belt<br>mm/" | Ø<br>max " | €            |   |
|---------------|--------|---------|----------------|------------|--------------|---|
| <b>111330</b> | 9      | 225     | 530/21         | 4          | <b>14,26</b> | 1 |

**Strap wrench**

**ALUMINIUM**

**STRAP**  
**L: 104 cm**

- Body made in aluminium
- Nylon strap



| Code          | L<br>"          | L<br>mm | L belt<br>mm/" | Ø<br>max " | €            |   |
|---------------|-----------------|---------|----------------|------------|--------------|---|
| <b>111338</b> | 12              | 300     | 1040/42        | 8          | <b>30,16</b> | 1 |
| SPARE STRAP   |                 |         |                |            |              |   |
| <b>111339</b> | for code 111338 |         |                |            | <b>12,04</b> | 1 |

## Pipe vice

CAST IRON

Dimensions: 325x220x200 mm



- Cast iron body
- Induction tempered jaws
- Upper mobile jaw
- With holes for fixation to table

| Code          | Ø<br>" | Ø<br>mm | €            |   |
|---------------|--------|---------|--------------|---|
| <b>199335</b> | 2      | 60      | <b>56,89</b> | 1 |

## Plastic pipe cutter Ø 42 mm

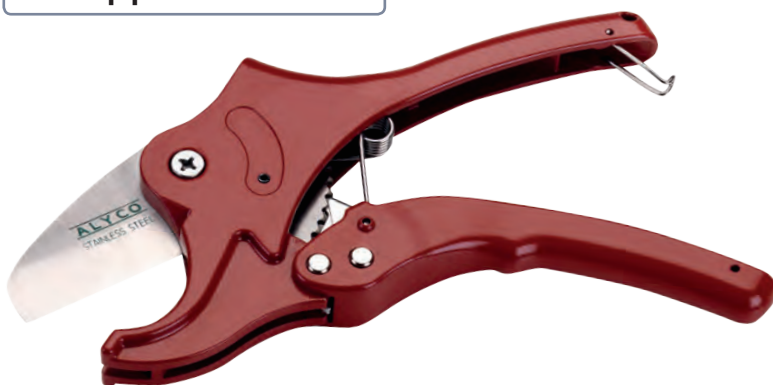

With plastic support for cutting flat surfaces between 45° and 90°

- Light Aluminium body
- Stainless steel "V" shaped blade
- Easy blade changing
- Safety latch
- Easy cutting due to the non-return ratchet mechanism.

### USE DIRECTIONS

- 1 Set up
- 2 Cutting
- 3 Chamfering

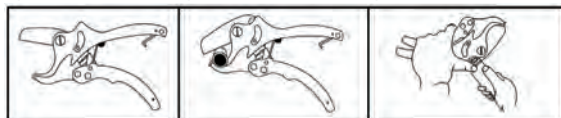

Remove the handle security locking and open the handles  
Place the tube between the blades and press  
Close the cutter

| Type of pipe | CUTTING CAPACITY |            |
|--------------|------------------|------------|
|              | Ø Inner mm       | Ø Outer mm |
| PVC          | 13-30            | 42         |
| Poliethylene | 30               | 42         |
| Wire         | 14-26            | 42         |

| Code          | Ø mm | €            |   |
|---------------|------|--------------|---|
| <b>108260</b> | 42   | <b>44,35</b> | 1 |

Display with blister

## Plastic pipe cutter Ø 27 mm



| Type of pipe | CUTTING CAPACITY |            |
|--------------|------------------|------------|
|              | Ø Inner mm       | Ø Outer mm |
| PVC          | 13-20            | 27         |
| Poliethylene | 20               | 27         |
| Wire         | 14-20            | 27         |

- Same features as 108260
- Plastic support not included

| Code          | Ø mm | €            |   |
|---------------|------|--------------|---|
| <b>108250</b> | 27   | <b>25,84</b> | 1 |

Display with blister

## Spare blade for PVC pipe cutters

STAINLESS STEEL



Very sharp blade. Wear gloves during blade change

| Code          | for code | €            |   |
|---------------|----------|--------------|---|
| <b>108265</b> | 108260   | <b>10,51</b> | 1 |
| <b>108255</b> | 108250   | <b>6,39</b>  | 1 |

Display with blister

**Telescopic pipe cutter**

**CAPACITY**  
Ø 6-70 mm



**INCLUDES:**



| Code               | L mm      | €            |    |
|--------------------|-----------|--------------|----|
| <b>111520</b>      | 220       | <b>59,35</b> | 1  |
| <b>SPARE BLADE</b> |           |              |    |
| <b>111525</b>      | Cu-Bro-Al | <b>3,87</b>  | 10 |

**Display with blister**

**Telescopic pipe cutter**

**CAPACITY**  
Ø 3-45 mm



**INCLUDES:**



- Aluminium body. Very light.
- Ergonomic handle.
- 4 polished rollers with grooves for flared tubes.
- With retractable rotating reamer
- Delivered with a spare blade inside the handle 111525

| Code               | L mm      | €            |    |
|--------------------|-----------|--------------|----|
| <b>111514</b>      | 170       | <b>35,30</b> | 1  |
| <b>SPARE BLADE</b> |           |              |    |
| <b>111525</b>      | Cu-Bro-Al | <b>3,87</b>  | 10 |

**Display with blister**

**Telescopic pipe cutter**

**CAPACITY**  
Ø 3-35 mm



**INCLUDES:**



- Aluminium body. Very light.
- Ergonomic handle.
- 4 polished rollers with grooves for flared tubes.
- With retractable rotating reamer
- Delivered with a spare blade inside the handle 111525

| Code               | L mm      | €            |    |
|--------------------|-----------|--------------|----|
| <b>111513</b>      | 140       | <b>18,45</b> | 1  |
| <b>SPARE BLADE</b> |           |              |    |
| <b>111525</b>      | Cu-Bro-Al | <b>3,87</b>  | 10 |

**Display with blister**

## Pipe cutter

**CAPACITY**  
Ø 3-30 mm



**INCLUDES:**



- Aluminium body. Very light.
- Ergonomic handle.
- 2 polished rollers with grooves for flared tubes.
- With foldable blade reamer inside the body.
- Cutting wheel for brass, copper and aluminium pipe

| Code          | L mm      | €            |    |
|---------------|-----------|--------------|----|
| <b>111510</b> | 150       | <b>13,25</b> | 6  |
| SPARE BLADE   |           |              |    |
| <b>111535</b> | Cu-Bro-Al | <b>2,83</b>  | 10 |

**Display with blister**

## Pipe cutter

**CAPACITY**  
Ø 15-45 mm



**INCLUDES:**



- Aluminium body. Very light.
- Ergonomic handle.
- 2 polished rollers with grooves for flared tubes.
- With foldable blade reamer inside the body.
- Cutting wheel for brass, copper and aluminium pipe

| Code          | L mm      | €            |    |
|---------------|-----------|--------------|----|
| <b>111511</b> | 170       | <b>18,50</b> | 2  |
| SPARE BLADE   |           |              |    |
| <b>111534</b> | Cu-Bro-Al | <b>3,39</b>  | 10 |

**Display with blister**

## Mini pipe cutter



**INCLUDES:**



- Aluminium body
- 2 polished rollers with grooves for flared tubes.
- Suitable for copper, brass and aluminium pipe

| Code          | Ø mm      | €            |    |
|---------------|-----------|--------------|----|
| <b>111505</b> | 3-16      | <b>9,59</b>  | 1  |
| <b>111506</b> | 3-22      | <b>9,94</b>  | 1  |
| <b>111507</b> | 3-28      | <b>10,81</b> | 1  |
| SPARE BLADE   |           |              |    |
| <b>111535</b> | Cu-Bro-Al | <b>2,83</b>  | 10 |

**Display with blister**

## Automatic pipe cutter

### INSTRUCTIONS USE:

- Put the pipe in the inside part of the cutter. It will fit automatically.
- Turn round several times until the pipe is cut.
- All measures of pipe cutters are using the same blade 111538



| Code          | Ø mm      | Ø mm Pipe | €            |    |
|---------------|-----------|-----------|--------------|----|
| <b>111501</b> | 48        | 10        | <b>17,72</b> | 1  |
| <b>111502</b> | 52        | 12        | <b>18,82</b> | 1  |
| <b>111503</b> | 56        | 15        | <b>20,18</b> | 1  |
| <b>111504</b> | 68        | 22        | <b>21,53</b> | 1  |
| SPARE BLADE   |           |           |              |    |
| <b>111538</b> | Cu-Bro-Al |           | <b>3,87</b>  | 10 |

**Display with blister**

**Steel pipe cutter**

**CAPACITY**  
Ø 12-50 mm



**Steel pipe cutter**

**CAPACITY**  
Ø 32-100 mm



Including bar of 300 mm for strong tightening

**Deburring tool, plastic body**



**INCLUDES:**



- Can be used in two directions
- Includes HSS steel replacement blade

| Code          | L mm | €            |   |
|---------------|------|--------------|---|
| <b>111545</b> | 150  | <b>11,91</b> | 6 |

**Spare blade**



**Tube reamer**



For reaming the outer side of the pipe



For reaming the inner side of the pipe

**Used for steel tubes**

- Steel body reinforced
- 2 polished rollers
- Handle in T to make the tightening easier

| Code          | L mm  | €            |   |
|---------------|-------|--------------|---|
| <b>111522</b> | 400   | <b>78,49</b> | 1 |
| SPARE BLADE   |       |              |   |
| <b>111536</b> | Steel | <b>12,61</b> | 1 |

**Used for steel tubes**

- Steel body reinforced
- 2 polished rollers
- Handle in T to make the tightening easier

| Code          | L mm  | €             |   |
|---------------|-------|---------------|---|
| <b>111524</b> | 510   | <b>128,87</b> | 1 |
| SPARE BLADE   |       |               |   |
| <b>111537</b> | Steel | <b>17,36</b>  | 1 |

**Deburring tool, metallic body**



- Can be used in two directions

| Code          | L mm | €           |   |
|---------------|------|-------------|---|
| <b>111550</b> | 150  | <b>9,50</b> | 6 |

| Code          | For code       | €           |   |
|---------------|----------------|-------------|---|
| <b>111551</b> | 111545, 111550 | <b>5,03</b> | 6 |

- 3 blades made of Steel.
- Cylindrical body made of hard plastic.
- For reaming both the inner and outer side of the pipe between 3 and 40 mm.

| Code          | Pipe Ø mm | €            |   |
|---------------|-----------|--------------|---|
| <b>111540</b> | 3-40      | <b>12,99</b> | 1 |



## Heavy duty magnetic level

**ACCURACY:**

- 0,5 mm/m standard position
- 0,75 mm/m reversed position

Special ergonomic frame shape

Made of Aluminium alloy with 2 machined faces for a higher accuracy

Sides shock-proof protected with rubber end caps

Rubber coated handle for comfortable handling feel

High magnetic strength. 3 kg strength magnets on sides and 5 kg on central area. Magnets located inside the level frame (not visible).

Finely milled top and bottom V-shape slot

| Code          | L mm | A mm | B mm | €            |   |
|---------------|------|------|------|--------------|---|
| <b>196204</b> | 400  | 28   | 60   | <b>26,50</b> | 1 |
| <b>196206</b> | 600  | 28   | 60   | <b>31,83</b> | 1 |
| <b>196208</b> | 800  | 28   | 60   | <b>37,18</b> | 1 |
| <b>196210</b> | 1000 | 28   | 60   | <b>47,70</b> | 1 |
| <b>196212</b> | 1200 | 28   | 60   | <b>53,76</b> | 1 |

196204 (only one handle)

## Heavy duty trapezoidal magnetic level

**ACCURACY:**

- 0,5 mm/m standard position

Hole for hanging

Beating surface. Due to the heavy duty frame this zone can be beaten for leveling

Heavy duty Aluminium alloy frame

Magnetic base. High magnetic strength

600 and 800 mm. sizes with 3 vials (horizontal, vertical and 45° vial) and 16" mm with two vials (horizontal and vertical)

| Code          | L mm | €            |   |
|---------------|------|--------------|---|
| <b>196290</b> | 400  | <b>22,07</b> | 1 |
| <b>196292</b> | 600  | <b>29,33</b> | 1 |
| <b>196294</b> | 800  | <b>43,01</b> | 1 |

**Tubular spirit level**

**ACCURACY**

 **0,75 mm/m**  
standard position

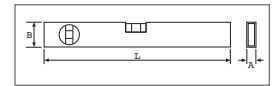

- M-shape Aluminum frame for a higher resistance.
- Milled levelling surface.
- Three vials: horizontal, vertical and 45°.
- Levelling face with V-shaped slot for working with round surfaces

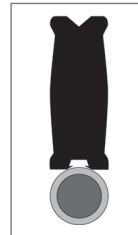

Special shape

| Code          | L mm | A mm | B mm | €            |  |
|---------------|------|------|------|--------------|---|
| <b>196005</b> | 400  | 28   | 65   | <b>10,53</b> | 6   |
| <b>196010</b> | 600  | 28   | 65   | <b>17,50</b> | 6   |
| <b>196015</b> | 800  | 28   | 65   | <b>20,97</b> | 6   |
| <b>196020</b> | 1000 | 28   | 65   | <b>27,89</b> | 1   |
| <b>196025</b> | 1200 | 28   | 65   | <b>31,72</b> | 1   |

**Tubular magnetic spirit level**

**ACCURACY**

 **0,75 mm/m**  
standard position

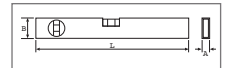

- Rectangular shape Aluminium frame.
- Vials: horizontal, vertical and 45°
- With 2 strong magnets at the base for fixing on metal surfaces.



2 magnets

| Code          | L mm | A mm | B mm | €            |  |
|---------------|------|------|------|--------------|---|
| <b>196180</b> | 400  | 20   | 50   | <b>13,52</b> | 6   |
| <b>196182</b> | 600  | 20   | 50   | <b>16,72</b> | 6   |
| <b>196184</b> | 800  | 20   | 50   | <b>19,23</b> | 6   |

**Trapezoidal magnetic level**

**ACCURACY**

 **0,75 mm/m**  
standard position



- Special frame made of injected die-cast Aluminium alloy.
- Milled levelling face.
- 2 vials: horizontal and vertical.

| Code          | L mm | €            |  |
|---------------|------|--------------|---|
| <b>196280</b> | 400  | <b>10,21</b> | 6   |
| <b>196282</b> | 600  | <b>13,89</b> | 6   |

**Torpedo tubular magnetic level**

**ACCURACY**

 **0,75 mm/m**  
normal position

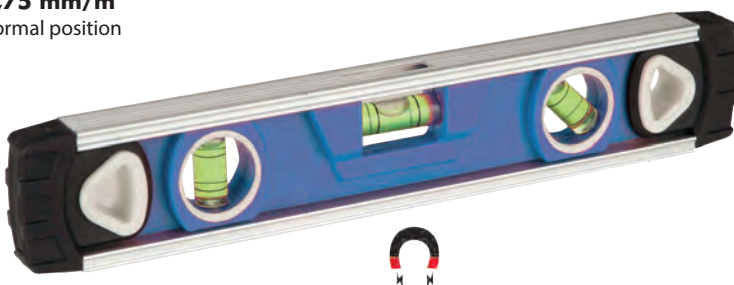

- Plastic frame with hanging hole.
- Magnetic base. Powerful magnets.
- 3 vials at 90°, 180° and 45°

| Code          | L mm | €           |  |
|---------------|------|-------------|---|
| <b>196252</b> | 235  | <b>5,50</b> | 6   |

## Magnetic torpedo tubular level



### ACCURACY

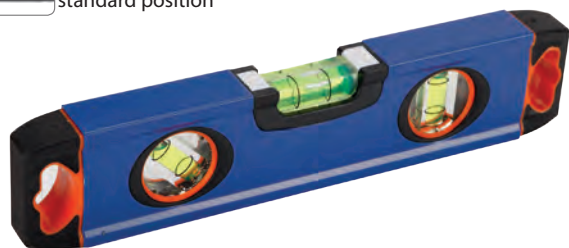

- Aluminium alloy frame.
- Magnetic base. Powerful magnets.
- 3 vials at 45°, 90° and 180°



| Code   | L mm | €     |   |
|--------|------|-------|---|
| 196203 | 250  | 12,96 | 6 |

## Magnetic trapezoidal level

### ACCURACY

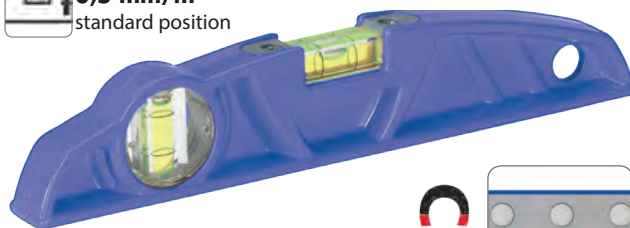

Magnetic surface

- Heavy duty aluminium
- 2 vials at 90° and 180°

| Code   | L mm | €     |   |
|--------|------|-------|---|
| 196288 | 250  | 15,50 | 6 |

## Mini pocket level with holder

### ACCURACY

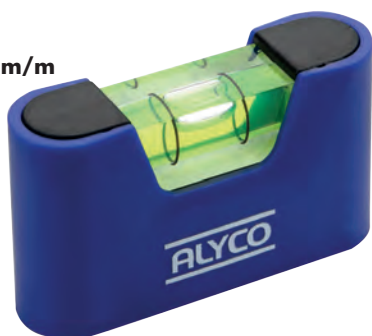

Dimensions: 70 x 20 x 41 mm



### INCLUDES HOLDER



Clip to hang



- Plastic body
- Lower magnetic base for horizontal leveling
- 1 vial

| Code   | €    |   |
|--------|------|---|
| 196255 | 5,02 | 6 |

## Self Leveling Laser Level Kit

**LASER CLASS 2**  
TYPE  $\lambda$  650 nm  
SCOPE 15 m

### ACCURACY



CAUTION



USE GLASSES

### APPLICATIONS

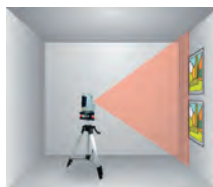

Vertical beam



Horizontal beam



Cross beam



### CONTENTS

- Self adjusting level (includes two batteries)
- Adjustable aluminum tripod of 120 cm tall
- Target plate
- Safety glasses
- Manual

### INCLUDES:



2 x AA

| Code   | €      |   |
|--------|--------|---|
| 196302 | 126,10 | 1 |



**Magnetic measuring tape**



**CLASS II**



Nylon coated to avoid graduation erasing



Magnetic end hook



In display of 12 units (except 197324)

- Impact resistant antislip box
- Self aligning hook accurate for external and internal measurement
- Belt metal clip on the back side

**ANTI BLOCK SYSTEM:**

- Return of the tape as usual
- Backward movement of the tape only when the button is pushed

**METRIC-IMPERIAL MARKING**



| Code          | m | mm | €           |    |  |
|---------------|---|----|-------------|----|--|
| <b>197307</b> | 3 | 16 | <b>3,55</b> | 12 |  |
| <b>197316</b> | 5 | 25 | <b>6,11</b> | 12 |  |

**METRIC MARKING**



| Code          | m | mm | €           |    |
|---------------|---|----|-------------|----|
| <b>197305</b> | 3 | 16 | <b>3,55</b> | 12 |
| <b>197315</b> | 5 | 25 | <b>6,11</b> | 12 |
| <b>197324</b> | 8 | 25 | <b>8,30</b> | 6  |

**Measuring tape**



**CLASS II**



**METRIC-IMPERIAL MARKING**



| Code          | m | mm | €           |    |  |
|---------------|---|----|-------------|----|--|
| <b>197303</b> | 3 | 16 | <b>2,63</b> | 12 |  |
| <b>197312</b> | 5 | 25 | <b>4,90</b> | 12 |  |

**METRIC MARKING**



| Code          | m  | mm | €            |    |
|---------------|----|----|--------------|----|
| <b>197300</b> | 3  | 16 | <b>2,63</b>  | 12 |
| <b>197310</b> | 5  | 25 | <b>4,90</b>  | 12 |
| <b>197320</b> | 8  | 25 | <b>6,53</b>  | 12 |
| <b>197322</b> | 10 | 25 | <b>10,70</b> | 6  |



In display of 12 units (in 197322 and 197320 not available)

- Tape made of steel.
- Frame covered with rubber coat, providing non-slip grip and greater comfort.
- End hook accurate for external and internal measurement.
- Three different brake positions: blocked, semi-blocked, free.
- Metal clip on the rear part



## Long steel measuring tape



CLASS II



Flush rewinding handle



Plastic ring holding system when the steel tape is folded

- Steel tape
- Initial part of the tape measure covered in plastic
- Ergonomic and bimaterial plastic case

| Code          | Ø m | mm | €            |   |
|---------------|-----|----|--------------|---|
| <b>197350</b> | 20  | 13 | <b>18,65</b> | 1 |
| <b>197360</b> | 30  | 13 | <b>26,10</b> | 1 |

Display with carton box

## Long fibreglass measuring tape



CLASS III



- Vinyl-coated fibreglass tape
- Tape marked on both sides
- Anti-shock plastic case
- Flush winding handle
- Elastic band for easy handling

| Code          | Ø m | mm   | €            |   |
|---------------|-----|------|--------------|---|
| <b>197325</b> | 20  | 12,5 | <b>13,32</b> | 1 |
| <b>197330</b> | 30  | 12,5 | <b>16,45</b> | 1 |

Display with carton box

## Long fibreglass measuring tape



CLASS III

50 M. LONG



Two-sided printed tape

Plastic ring

Zero mark



- Pointed tip to stick in ground
- Large-sized bimaterial handle
- Fast rewinding handle

| Code          | Ø m | mm | €            |   |
|---------------|-----|----|--------------|---|
| <b>197340</b> | 50  | 13 | <b>26,10</b> | 1 |

Display with carton box

## Foldable measuring wheel



MEASUREMENT CAPACITY 10.000 M.



Brake and distance controller in the handle



Wheel in the central axle

TRIPLE FOLDING



- Unfolded: 1040 mm - Folded: 430 mm
- Weight 1,1 kg

| Code          | Ø wheel mm | €            |   |
|---------------|------------|--------------|---|
| <b>197357</b> | 160        | <b>93,32</b> | 1 |

Display with carton box

**Measuring wheel**



Folding

**MEASUREMENT CAPACITY  
10.000 M.**

- Wheel made of polyurethane
- Aluminum bar with ergonomic rubber handle
- Reset button
- Metal foot to rest the wheel

| Code          | Ø wheel mm | €            |   |
|---------------|------------|--------------|---|
| <b>197355</b> | 300        | <b>77,75</b> | 1 |

**Display with blister**

**Chalk line**

**30 M. LONG**



Cotton line can be locked at any length (can be used as plumb line)

- Ergonomic waterproof plastic case
- Chalk filling hole
- Cotton cord 30 m long does not fray
- Fold away winding handle
- Metal end support

| Code          | L m | €           |   |
|---------------|-----|-------------|---|
| <b>196190</b> | 30  | <b>8,91</b> | 5 |

**Display with blister**

**Chalk line and bottle set**



**CONTENTS**

- 196190 chalk line
- 125 gr. blue chalk powder.

| Code          | €            |   |
|---------------|--------------|---|
| <b>196195</b> | <b>10,16</b> | 5 |

**Display with blister**

**Blue chalk refill**

**BLUE COLOUR  
POWDER**



196197



196199



196200

- Special plastic bottle for an easier recharge of powder.
- Very thin blue chalk powder.

| Code          | Weight gr | €           |    |
|---------------|-----------|-------------|----|
| <b>196197</b> | 250       | <b>2,60</b> | 10 |
| <b>196199</b> | 500       | <b>4,36</b> | 6  |
| <b>196200</b> | 1000      | <b>6,48</b> | 4  |

## Engineers precision square

STAINLESS  
STEEL

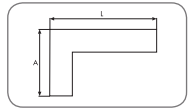

Graduated

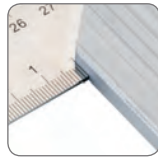

Reinforced joint

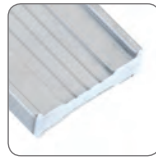

Reinforced profile

- Blade made in Stainless Steel.
- Two-sided graduated rule.
- Handle made of Aluminium
- Riveted joint between handle and rule

| Code          | L x A mm | €            |   |
|---------------|----------|--------------|---|
| <b>197375</b> | 250x130  | <b>8,06</b>  | 6 |
| <b>197380</b> | 300x150  | <b>9,50</b>  | 6 |
| <b>197385</b> | 400x180  | <b>11,76</b> | 6 |
| <b>197386</b> | 600x200  | <b>15,89</b> | 6 |

## Rule

STAINLESS  
STEEL

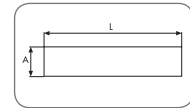

- Two-sided graduated rule

| Code          | L x A mm | €           |    |
|---------------|----------|-------------|----|
| <b>197280</b> | 200x20   | <b>1,07</b> | 12 |
| <b>197281</b> | 300x25   | <b>1,27</b> | 12 |
| <b>197282</b> | 500x25   | <b>2,81</b> | 12 |

## Mitre square

STAINLESS  
STEEL



- Rule made in Stainless Steel.
- Two-sided graduated rule.
- Handle made of Aluminium
- Angle graduation on the head to position the ruler at the desired angle.
- Tighten-release screw for the ruler. Capacity to adjust the angle and the length.

| Code          | L mm | €            |   |
|---------------|------|--------------|---|
| <b>197398</b> | 250  | <b>11,30</b> | 6 |
| <b>197399</b> | 300  | <b>12,66</b> | 6 |

## Square with aluminium handle



- Blade made of hardened steel.
- Aluminium handle
- Millimetre ruler on both sides.
- Secure riveted joint between blade and handle

| Code          | L mm | €           |    |
|---------------|------|-------------|----|
| <b>197390</b> | 250  | <b>3,93</b> | 10 |
| <b>197392</b> | 300  | <b>4,66</b> | 10 |
| <b>197394</b> | 400  | <b>5,54</b> | 10 |
| <b>197396</b> | 600  | <b>7,32</b> | 10 |

**10 in 1 multifunction square**

**STAINLESS  
STEEL**

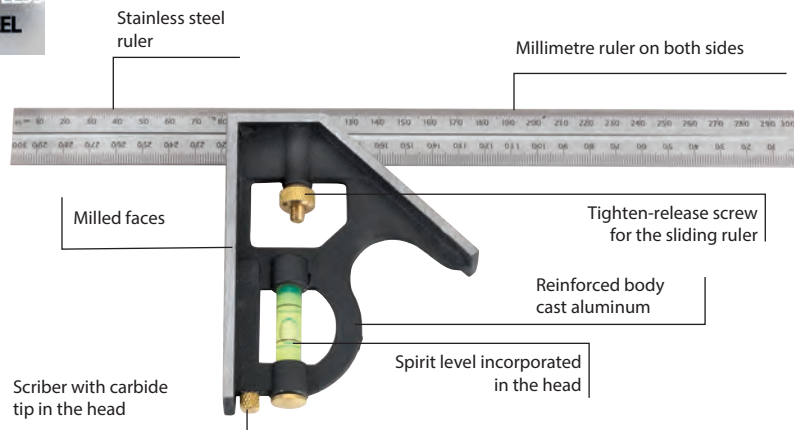

**FUNCTIONS:**

- Millimetre ruler
- 90° interior square
- 90° exterior square
- 135° interior square
- 45° interior square
- Horizontal levelling
- Vertical levelling
- T square with sliding ruler
- Interior measurement

| Code          | L mm | €            |   |
|---------------|------|--------------|---|
| <b>197415</b> | 300  | <b>15,35</b> | 6 |
| <b>197420</b> | 400  | <b>17,81</b> | 6 |

**Digital vernier calliper**

**STAINLESS  
STEEL**



- Displayer in mm and inches
- 40 mm depth jaws.
- Screw lock system.

| Code          | L mm | Accuracy mm | €            |   |
|---------------|------|-------------|--------------|---|
| <b>197372</b> | 150  | 0,01        | <b>38,44</b> | 1 |

**Vernier calliper**

**STAINLESS  
STEEL**



- Displayer in mm and inches
- 40 mm depth jaws.
- Screw lock system.

| Code          | L mm | Accuracy mm | €            |   |
|---------------|------|-------------|--------------|---|
| <b>197370</b> | 150  | 0,05        | <b>25,01</b> | 1 |

**External micrometer**



- Made of cast iron
- Thimble and sleeve made of steel
- Carbide plunger tip anvils
- Brake for reading fixation

| Code          | L mm | Accuracy mm | €            |   |
|---------------|------|-------------|--------------|---|
| <b>197374</b> | 0-25 | 0,01        | <b>24,46</b> | 1 |

Display in plastic case

## Thickness gauges



### CONTENTS

0,05- 0,10- 0,15- 0,20- 0,25- 0,30- 0,35- 0,40- 0,45- 0,50- 0,55- 0,60- 0,65- 0,70- 0,75- 0,80- 0,85- 0,90- 0,95- 1mm

| Code          | No. of gauges | €           |   |
|---------------|---------------|-------------|---|
| <b>197362</b> | 20            | <b>5,63</b> | 6 |

## Cilindric tip scriber

Cr-V  
STEEL



| Code          | mm  | Ø mm | €           |    |
|---------------|-----|------|-------------|----|
| <b>119132</b> | 125 | 6    | <b>4,30</b> | 12 |

## Carbide tip scriber and leads



• Scriber tip made of tungsten carbide.

| Code          | L mm | €            |    |
|---------------|------|--------------|----|
| <b>123000</b> | 150  | <b>15,12</b> | 10 |
| SPARE LEADS   |      |              |    |
| <b>140030</b> | 25   | <b>4,16</b>  | 10 |

## Engineers scriber

ANGLE 90°



• Body made of Chrome Vanadium Steel  
• Tip made in tungsten carbide  
• Tips hardened to 40-45 HRC

| Code          | L mm | Ø mm | €           |    |
|---------------|------|------|-------------|----|
| <b>123005</b> | 200  | 4    | <b>4,26</b> | 12 |

Display with blister

## Screw pitch gauges



### CONTENTS

0,25- 0,30- 0,35- 0,40- 0,45- 0,50- 0,60- 0,70- 0,75- 0,80- 0,90- 1- 1,25- 1,50- 1,75- 2- 2,5- 3- 3,5- 4- 4,5- 5- 5,5- 6 mm

| Code          | No. of gauges | €           |   |
|---------------|---------------|-------------|---|
| <b>197365</b> | 24            | <b>8,50</b> | 6 |

## Square tip scriber

Cr-V  
STEEL



| Code          | mm  | mm | €           |    |
|---------------|-----|----|-------------|----|
| <b>119134</b> | 125 | 6  | <b>4,36</b> | 12 |

## Carbide scriber



• Body of carbide pen scriber made of Chrome Vanadium Steel. Tip made in tungsten carbide.

| Code          | L mm | €           |    |
|---------------|------|-------------|----|
| <b>123001</b> | 150  | <b>6,14</b> | 10 |

**Spring divider**

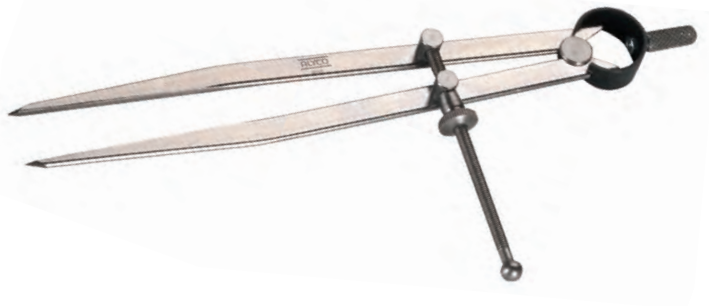

- Spring divider for marking.
- Tempered tips.
- Adjustment by knurled wheel.

| Code          | L mm | €            |   |
|---------------|------|--------------|---|
| <b>149001</b> | 100  | <b>13,25</b> | 6 |
| <b>149002</b> | 150  | <b>14,46</b> | 6 |
| <b>149003</b> | 200  | <b>17,46</b> | 6 |
| <b>149004</b> | 250  | <b>18,63</b> | 6 |

**Wood punches for hiding nail heads**



| Code          | Ø "  | €           |    |
|---------------|------|-------------|----|
| <b>140001</b> | 1/32 | <b>3,92</b> | 12 |
| <b>140002</b> | 2/32 | <b>3,92</b> | 12 |
| <b>140003</b> | 3/32 | <b>3,92</b> | 12 |
| <b>140004</b> | 4/32 | <b>3,92</b> | 12 |

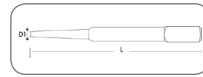

**Centre punch**



| Code          | Ø "  | €           |    |
|---------------|------|-------------|----|
| <b>140006</b> | 1/32 | <b>4,23</b> | 12 |
| <b>140007</b> | 2/32 | <b>4,23</b> | 12 |
| <b>140008</b> | 3/32 | <b>4,23</b> | 12 |
| <b>140009</b> | 4/32 | <b>4,23</b> | 12 |

**PUNCH SET**

| Code          | Size                           | €            |
|---------------|--------------------------------|--------------|
| <b>140005</b> | 140001/140002<br>140003/140004 | <b>15,70</b> |



**CENTRE PUNCH SET**

| Code          | Size                           | €            |
|---------------|--------------------------------|--------------|
| <b>140010</b> | 140006/140007<br>140008/140009 | <b>16,90</b> |

**Centre punch for wood**



| Code          | L mm | €           |    |
|---------------|------|-------------|----|
| <b>140011</b> | 100  | <b>4,42</b> | 12 |

**Thin tipped ink marker pen**



- Permanent ink markers
- 9 mm thin tip

| Code          | L mm | Color | €           |    |
|---------------|------|-------|-------------|----|
| <b>149081</b> | 120  | Red   | <b>1,11</b> | 12 |
| <b>149086</b> | 120  | Black | <b>1,11</b> | 12 |
| <b>149087</b> | 120  | Blue  | <b>1,11</b> | 12 |

**Carpenter pencil**



| Code          | L mm | €           |     |
|---------------|------|-------------|-----|
| <b>149050</b> | 175  | <b>0,38</b> | 144 |

- Pencil with graphite lead
- Oval-shaped bod
- Delivered unsharpened

**2 colour Carpenter pencil**



**Blue Red**

| Code          | L mm | €           |     |
|---------------|------|-------------|-----|
| <b>149055</b> | 175  | <b>0,49</b> | 144 |

In counter top display

In counter top display



## 13 Lighting and electricity



**Worklight** 237



**Head lamp** 240



**Torch** 242



**Inspection lamp** 243



**Cable reel** 243



**Extension cable** 245



**Booster cable** 246



**Booster clamp** 247



**Rechargeable COB Flashlight**



Swivel joint 180°

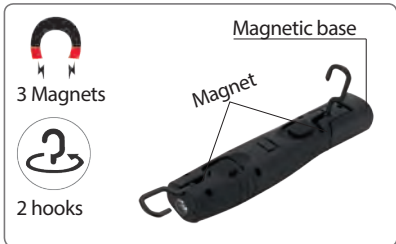

- Autonomy: Front focus 3.5 h. Top Focus 8h.
- Recharge time 5-6h.

| Code   | L mm | €     |   |
|--------|------|-------|---|
| 190572 | 285  | 62,20 | 1 |

**Rechargeable flashlight with stand**



Changing through the base



Swivel Hook 360°



- Autonomy 6h.
- Recharge time 5-6h.

| Code   | L mm | €     |   |
|--------|------|-------|---|
| 190576 | 280  | 49,00 | 1 |

30 LED bifocal flashlight



| Code   | L mm | €     |    |
|--------|------|-------|----|
| 190511 | 210  | 15,27 | 12 |

In countertop display

Rechargeable inspection lamp

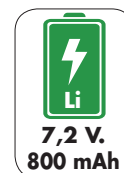
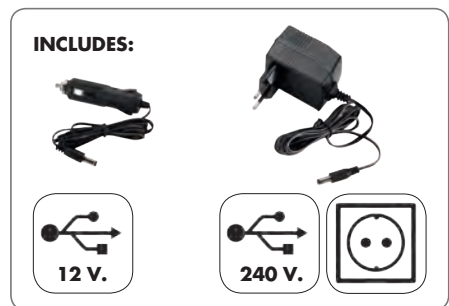

- Autonomy 3h.
- Recharge time 5-6h.

Includes magnetic support dockable to the body of the lamp

| Code   | L mm | €     |   |
|--------|------|-------|---|
| 190501 | 420  | 31,60 | 1 |



**Mini 27 LED bifocal worklight**



24 LED
 86 Lumen



3 LED
 10 Lumen



**NEW DESIGN FOR FAST CHANGE OF BATTERIES**



**INCLUDES:**

**3 x AAA**

- Body made of ABS plastic
- Double switch position  
1- Main focus, 2- Front focus

| Code          | L mm | €           |    |
|---------------|------|-------------|----|
| <b>190540</b> | 100  | <b>7,40</b> | 12 |

**In countertop display**

**COB-LED pocket worklight**



COB
 100 Lumen

1 LED
 15 Lumen



**INCLUDES:**

**3 x AAA**

- Body made of ABS plastic
- Double switch position  
1- Main focus, 2- Front focus

| Code          | L mm | €           |    |
|---------------|------|-------------|----|
| <b>190544</b> | 180  | <b>5,36</b> | 12 |

**In countertop display**

## CREE LED head lamp



Aluminum and ABS plastic structure



Adjustable head positioning



### FUNCTIONS:



Maximum light



Half light



Flash

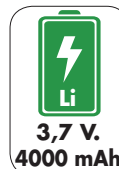

- Autonomy 4-5h.
- Charging time 4-5h.

### INCLUDES:



| Code   | €     |   |
|--------|-------|---|
| 190562 | 28,50 | 1 |

Display with case

## CREE LED head lamp



Aluminum and ABS plastic structure

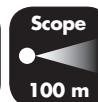

Adjustable head positioning



### FUNCTIONS:



Maximum light



Half light



Flash

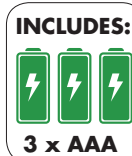

| Code   | €     |    |
|--------|-------|----|
| 190564 | 16,30 | 12 |

Display with blister

## COB head lamp

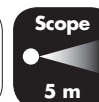

Adjustable head positioning



### FUNCTIONS:



Maximum light



Half light



Flash



| Code   | €     |    |
|--------|-------|----|
| 190566 | 12,00 | 12 |

Display with blister

**LED head lamp**

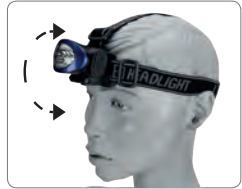

Adjustable head positioning



**FUNCTIONS:**

4 LED    10 LED    Flash

**INCLUDES:**

3 x AAA

| Code   | €    |    |
|--------|------|----|
| 190568 | 5,60 | 10 |

Display with blister

**Flexi-Head Torch pick-up tool**



- Aluminum housing Ø 15 mm
- Focusing Ø 23 mm

**INCLUDES:**

4 x LR44

**EXTENDABLE**

170 mm

565 mm

| Code   | €    |    |
|--------|------|----|
| 190570 | 9,20 | 12 |

Display with blister

**LED torch**



**INCLUDES:**

3,7 V.  
2000 mAh

- Autonomy 3h.
- Recharge time 5-6h.

| Code   | Ø mm | €     |   |
|--------|------|-------|---|
| 190552 | 80   | 30,60 | 1 |

Display with carton box

## Tubular torch Ø 54 mm



5 W  
CREE LED

300 Lumen

Scope  
150 m

ZOOM



ALUMINIUM FRAME



INCLUDES:



2 x 2D

FUNCTIONS:



- Body made of aluminum
- Impact and water resistant lens

| Code   | L mm | €     |   |
|--------|------|-------|---|
| 190577 | 250  | 35,70 | 1 |

Display with blister

## Tubular flashlight Ø 34 mm



5 W  
CREE LED

220 Lumen

Scope  
150 m

ZOOM



ALUMINIUM FRAME



INCLUDES:



3 x AAA

FUNCTIONS:

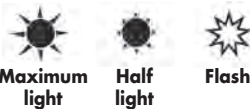

- Body made of aluminum
- Impact and water resistant lens

| Code   | L mm | €     |   |
|--------|------|-------|---|
| 190575 | 130  | 19,40 | 1 |

## Underbonnet Inspection Lamp



SMD  
15 W

1500 Lumen

Scope  
150 m



EXTENDABLE BODY  
127 - 210 CM

- Rubber coated hooks to prevent damaging the bonnet
- With 5 m. Cable 2 x 1'0 mm2

| Code   | €     |   |
|--------|-------|---|
| 190574 | 88,70 | 1 |

Display with carton box

**Fluorescent inspection lamp**



**2x0,75**  
Wires mm<sup>2</sup>

**COPPER  
CABLE**



**CABLE LENGTH  
10 M**

| Code          | €            |   |
|---------------|--------------|---|
| <b>190532</b> | <b>10,36</b> | 5 |

**Display with blister**

**Inspection lamp**



**2x0,75**  
Wires mm<sup>2</sup>

**COPPER  
CABLE**



**CABLE LENGTH  
10 M**

- Bulb not included
- Protective cage
- Reflective head

| Code          | €            |   |
|---------------|--------------|---|
| <b>190535</b> | <b>16,63</b> | 5 |

**Display in plastic bag**

**Cable reels**



**25 50**  
**M. M.**

**Cu**

**3x1,5**  
Wires mm<sup>2</sup>

**COPPER  
CABLE**



**PROTECTION IP44**

- For outdoor use
- Special sealing of lids
- Cable with thicker rubber
- Dust protection: objects with a diameter greater than 1 mm.
- Protection against water: water projected in all directions

**ELECTRICAL FEATURES**

- MAX. 1000 W - 230 V - 4,3 A**
- MAX. 3000 W - 230 V - 13 A**

TYPE OF CABLE: H05VV-F

| Code          | L m | €             |   |
|---------------|-----|---------------|---|
| <b>199407</b> | 25  | <b>66,17</b>  | 1 |
| <b>199432</b> | 50  | <b>106,33</b> | 1 |

**Display in carton box**

## Cable reels with safety lids



WITH COVERS



COPPER CABLE



## Cable reels



COPPER CABLE



### ELECTRICAL FEATURES



MAX. 1000 W - 230 V - 4,3 A



MAX. 3000 W - 230 V - 13 A

TYPE OF CABLE: H05VV-F



25 M. 50 M.

- Base and handgrip frame made of metal
- Reel made of hard plastic material
- Sockets with thermal safety device (red button)
- Plastic handle for rewinding and unwinding the cable
- Handle cover with non-slip rubber material

| Code   | L m | €     |   |
|--------|-----|-------|---|
| 199405 | 25  | 51,13 | 1 |
| 199430 | 50  | 81,24 | 1 |

Display in carton box

## Short cable reels



COPPER CABLE



5 M. 10 M. 15 M.



- Reel made of hard plastic material
- Cable reel with four sockets without cover (for internal jobs)
- Sockets with thermal safety device (red button)

| Code   | L m | €     |   |
|--------|-----|-------|---|
| 199409 | 5   | 12,68 | 5 |
| 199410 | 10  | 18,50 | 5 |
| 199415 | 15  | 25,56 | 5 |

Display in carton box

**Extension leads**



**CABLE LENGTH:  
1,40 M**



**3x1,5**  
Wires mm<sup>2</sup>



**SECURITY COPPER CABLE**

**ELECTRICAL FEATURES**



MAX. 3680 W - 250 V - 16 A

TYPE OF CABLE: H05VV-F

- Extension sockets with children protection.
- Bipolar + ground cable.

| Code          | No. of sockets | €           |   |
|---------------|----------------|-------------|---|
| <b>199453</b> | 3              | <b>4,83</b> | 6 |
| <b>199454</b> | 4              | <b>5,24</b> | 6 |
| <b>199455</b> | 5              | <b>5,65</b> | 6 |
| <b>199456</b> | 6              | <b>6,15</b> | 6 |

**Extension sockets with switch**



**CABLE LENGTH:  
1,40 M**



**3x1,5**  
Wires mm<sup>2</sup>



**SECURITY COPPER CABLE**

**ELECTRICAL FEATURES**



MAX. 3680 W - 250 V - 16 A

TYPE OF CABLE: H05VV-F

- Extension sockets with children protection.
- Bipolar + ground cable.

| Code          | No. of sockets | €           |   |
|---------------|----------------|-------------|---|
| <b>199463</b> | 3              | <b>6,14</b> | 6 |
| <b>199464</b> | 4              | <b>6,56</b> | 6 |
| <b>199465</b> | 5              | <b>6,96</b> | 6 |
| <b>199466</b> | 6              | <b>7,49</b> | 6 |

**Cable extensions**



**LENGTHS: 2, 3,  
4 AND 5 M**



**3x1,5**  
Wires mm<sup>2</sup>



**SECURITY COPPER CABLE**

**ELECTRICAL FEATURES**



MAX. 3680 W - 250 V - 16 A

TYPE OF CABLE: H05VV-F

- Extension with baby protection system.
- PVC covered cable.
- Bipolar + ground cable.

| Code          | L m | €            |   |
|---------------|-----|--------------|---|
| <b>199472</b> | 2   | <b>6,08</b>  | 6 |
| <b>199473</b> | 3   | <b>7,69</b>  | 6 |
| <b>199474</b> | 4   | <b>9,36</b>  | 6 |
| <b>199475</b> | 5   | <b>11,04</b> | 6 |

### Heavy duty booster cable



**CLAMP**  
199370  
A **BRONZE**  
160x100 mm

**WIRE**



**Cu**  
100%

**LENGTH 3,5 M**  
**SECTION 35 mm<sup>2</sup>**



| Code   | €      |   |
|--------|--------|---|
| 199375 | 115,70 | 1 |

Display in plastic bag

### Copper booster cable



**CLAMP**  
A **STEEL BRONZE**  
185x120 mm

**WIRE**



**Cu**  
100%

**LENGTH 3,5 M**  
**SECTION 25 mm<sup>2</sup>**



| Code   | €     |   |
|--------|-------|---|
| 199377 | 55,00 | 1 |

Display in plastic bag

### Copper-Aluminum booster cable



**CLAMP**  
A **STEEL ZINC**  
190x130 mm

**WIRE**



**Cu**  
**Al**

**LENGTH 3 M**  
**SECTION 35 mm<sup>2</sup>**



| Code   | €     |   |
|--------|-------|---|
| 199382 | 21,40 | 4 |

Display in plastic bag

### Copper-Aluminum booster cable



**CLAMP**  
A **STEEL ZINC**  
190x130 mm

**WIRE**



**Cu**  
**Al**

**LENGTH 2,5 M**  
**SECTION 25 mm<sup>2</sup>**



| Code   | €     |   |
|--------|-------|---|
| 199380 | 16,30 | 5 |

Display in plastic bag

**Heavy duty bronze booster clamp set**

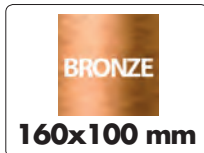
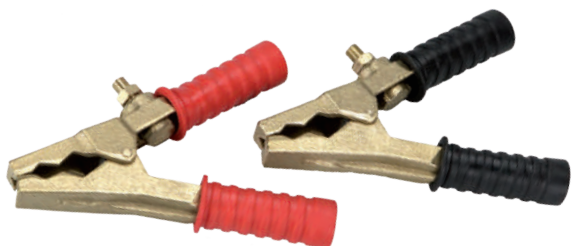

- Solid bronze body
- With screw for cable clamping
- Ergonomic PVC Insulated Handles
- Set of 2 clamps (1 red + 1 black)

| Code          | €            |  |
|---------------|--------------|---|
| <b>199370</b> | <b>30,40</b> | <b>1</b>  |

**Display in PVC bag**

**Steel booster clamp set**



- Zinc-coated steel body
- Ergonomic PVC Insulated Handles
- Set of 2 clamps (1 red + 1 black)

| Code          | €           |  |
|---------------|-------------|---|
| <b>199369</b> | <b>2,65</b> | <b>12</b>   |

**Display in PVC bag**

**Steel booster clamp set**

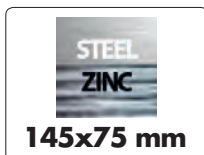

- Zinc-coated steel body
- Ergonomic PVC Insulated Handles
- Set of 2 clamps (1 red + 1 black)

| Code          | €           |  |
|---------------|-------------|---|
| <b>199367</b> | <b>1,95</b> | <b>12</b>   |

**Display in PVC bag**

**Steel booster clamp set**



- Zinc-coated steel body
- Ergonomic PVC Insulated Handles
- Set of 2 clamps (1 red + 1 black)

| Code          | €           |  |
|---------------|-------------|---|
| <b>199365</b> | <b>1,35</b> | <b>12</b>   |

**Display in PVC bag**



## 14 Miscellaneous tools



**Bench vice** 249



**Suction lifter** 251



**Telescopic mirror** 252



**Wire guide** 252



**Puller** 254



**Multi-tool** 257



**Riveter** 258



**Oil filter wrench** 260



**Electric welder** 261



**Glue gun** 261



**Caulking gun** 262



**Mortar applicator** 262



**Polyurethan applicator** 263



**Grease gun** 264



**Fuel can** 265



**Oil can** 265

**Round cylinder bench vice**

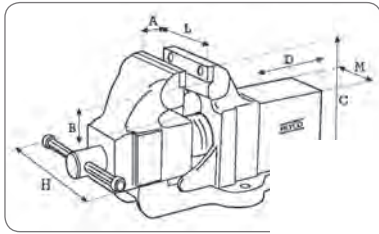

Two lubrication points for a proper maintenance of the inner mechanism (second point on the back side)



End caps on the spinning handle to prevent falling

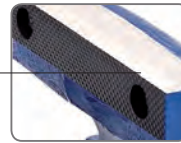

Anvil with an ample beating area

All bench vices made of high resistance steel

2nd lubrication point

Holes for bolting to a workbench with screws

Inner spindle completely covered by cylinder guide

Both drop forged jaws (fixed and movable jaws)

- Interchangeable parallel jaw plates
- Tempered jaws for a longer work life
- Knurled jaws for a better grip
- Can be used with rubber magnetic jaws

| VICE FEATURES |      |      |      |         |      |                 |
|---------------|------|------|------|---------|------|-----------------|
| Code          | A mm | B mm | C mm | DxM mm  | H mm | Max strength kg |
| 199350        | 110  | 61   | 197  | 109x100 | 13   | 5000            |
| 199355        | 135  | 63   | 225  | 144x125 | 14   | 6500            |
| 199360        | 165  | 72   | 247  | 152x150 | 15   | 7500            |

| Code          | L mm | Weight Kg | €             |   |
|---------------|------|-----------|---------------|---|
| <b>199350</b> | 100  | 15        | <b>257,45</b> | 1 |
| <b>199355</b> | 125  | 23        | <b>346,60</b> | 1 |
| <b>199360</b> | 150  | 32        | <b>483,82</b> | 1 |

See accessories on next page

**Utility bench vice**



- All made of Steel
- Both drop forged fixed and movable jaws
- Jaws:
  - Interchangeable
  - Tempered for a longer work life
  - Knurled for a better grip
- With 360° swivel base
- Beating area on the anvil
- V-shaped jaws for clamping tubes

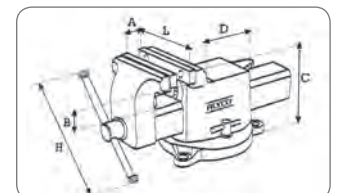

| VICE FEATURES |      |      |      |        |      |                 |
|---------------|------|------|------|--------|------|-----------------|
| Code          | A mm | B mm | C mm | DxM mm | H mm | Max strength kg |
| 199300        | 75   | 33   | 137  | 39     | 11   | 2500            |
| 199305        | 100  | 43   | 145  | 49     | 11   | 3500            |
| 199310        | 125  | 44   | 145  | 49     | 12   | 4000            |
| 199315        | 150  | 56   | 181  | 74     | 13   | 5000            |

| Code          | L mm | Weight Kg | €             |   |
|---------------|------|-----------|---------------|---|
| <b>199300</b> | 75   | 6         | <b>100,16</b> | 1 |
| <b>199305</b> | 100  | 7,5       | <b>120,20</b> | 1 |
| <b>199310</b> | 125  | 11        | <b>143,54</b> | 1 |
| <b>199315</b> | 150  | 14,5      | <b>179,14</b> | 1 |

See accessories on next page

## Bench vice

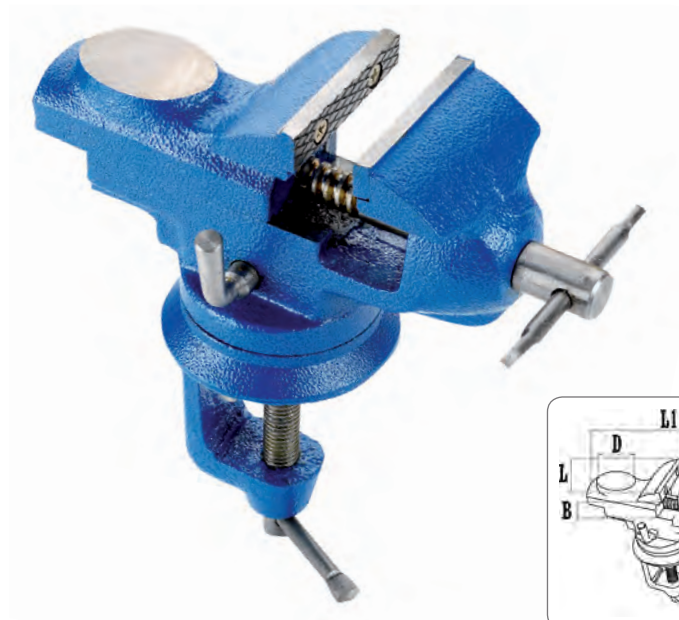

**TIGHTENING CAPACITY**



- Cast iron manufactured.
- Parallel jaws:
  - Interchangeable
  - Tempered for a longer work life
  - Knurled for a better grip
- Includes swivel base 360°.
- Beating area on the anvil.

### VICE FEATURES

| A max. mm | B mm | H mm | H1 mm | D mm | L1 mm | H2 mm |
|-----------|------|------|-------|------|-------|-------|
| 90        | 38   | 100  | 126   | 55   | 200   | 62    |

| Code          | L mm | Weight Kg | €            |   |
|---------------|------|-----------|--------------|---|
| <b>199325</b> | 65   | 4         | <b>74,17</b> | 1 |

## Metal jaw



- Jaws made of Cr-V Steel. Hardened and knurled
- With assembling screws included

| Code          | L mm | mm  | For code | €            |        |
|---------------|------|-----|----------|--------------|--------|
| <b>199351</b> | 100  | 70  | 199350   | <b>21,61</b> | 1 pair |
| <b>199356</b> | 125  | 87  | 199355   | <b>32,62</b> | 1 pair |
| <b>199361</b> | 150  | 108 | 199360   | <b>38,07</b> | 1 pair |
| <b>199301</b> | 75   | 58  | 199300   | <b>18,03</b> | 1 pair |
| <b>199306</b> | 100  | 70  | 199305   | <b>22,66</b> | 1 pair |
| <b>199311</b> | 125  | 87  | 199310   | <b>25,96</b> | 1 pair |
| <b>199316</b> | 150  | 108 | 199315   | <b>27,13</b> | 1 pair |

Price by pair of jaws

## Rubber jaw



- Magnetic band for attaching on the bench vice
- Jaws made of rubber material

| Code          | L mm | For code      | €            |        |
|---------------|------|---------------|--------------|--------|
| <b>199303</b> | 75   | 199300        | <b>24,93</b> | 1 pair |
| <b>199308</b> | 100  | 199350/199305 | <b>30,34</b> | 1 pair |
| <b>199313</b> | 125  | 199355/199310 | <b>35,64</b> | 1 pair |
| <b>199318</b> | 150  | 199360/199315 | <b>37,70</b> | 1 pair |

Price by pair of jaws

## Swivel base

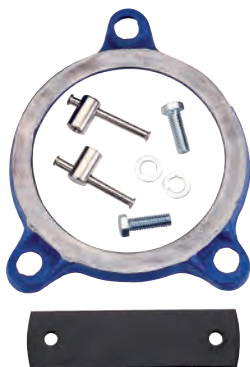

- Screws, pins and Steel plate for assembling on the workbench included.

| Code          | For code | €            |   |
|---------------|----------|--------------|---|
| <b>199302</b> | 199300   | <b>17,81</b> | 1 |
| <b>199307</b> | 199305   | <b>21,72</b> | 1 |
| <b>199312</b> | 199310   | <b>26,34</b> | 1 |
| <b>199317</b> | 199315   | <b>31,42</b> | 1 |

**Drill press vice**

**TIGHTENING CAPACITY**



**USE:**  
- Table drill  
- Work benches

**VICE FEATURES**

| Max. Opening | Width H mm | Depth mm. |
|--------------|------------|-----------|
| <b>100</b>   | <b>100</b> | <b>36</b> |

- Side slots for fixing to benches.
- Steel jaws in V shape for round pieces.

| Code          | €            |   |
|---------------|--------------|---|
| <b>199330</b> | <b>26,35</b> | 1 |

**One piece suction lifter**

**SUCTION CAPACITY**



**USE:**  
- Glass - Marble  
- Plastic - Grain  
- Metal - Smooth surfaces

| Code          | ∅ mm | €            |   |
|---------------|------|--------------|---|
| <b>198005</b> | 100  | <b>17,00</b> | 2 |

**Two-piece suction lifter**

**SUCTION CAPACITY**



**USE:**  
- Glass - Marble  
- Plastic - Grain  
- Metal - Smooth surfaces

| Code          | ∅ mm  | €            |   |
|---------------|-------|--------------|---|
| <b>198010</b> | 2x100 | <b>42,00</b> | 1 |

**Magnetic angles**

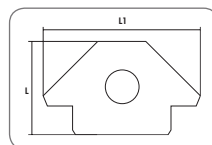
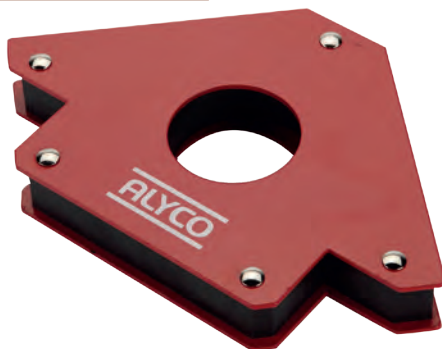

- Body made in steel.
- Body joined by rivets.
- Strong magnet inside.
- Hole to use it for lifting with a crane.

**USE:**

- For welding and assemblies at different angles (45°, 90°, 135°). Without the need for clamping.
- For lifting loads.
- Also used as a support for marking, pipe installation, separation of metal sheets.

| Code          | L mm | L1 mm | €            |    |
|---------------|------|-------|--------------|----|
| <b>197990</b> | 85   | 120   | <b>5,29</b>  | 10 |
| <b>197992</b> | 100  | 155   | <b>8,85</b>  | 10 |
| <b>197995</b> | 120  | 185   | <b>12,41</b> | 10 |

Display with blister

## Magnetic flexible pick-up tool with light

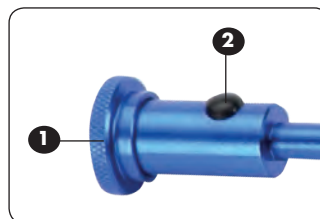
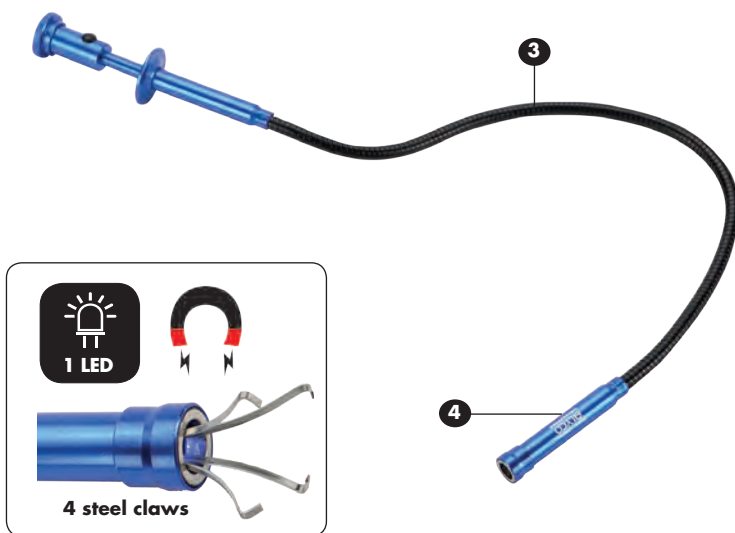

**INCLUDES:**  
  
**3 x LR44**

- 1** Button for opening the claws
- 2** LED light on / off button
- 3** Central part of the flexible body
- 4** Body made of light aluminum

| Code          | L mm | €            |   |
|---------------|------|--------------|---|
| <b>121550</b> | 600  | <b>11,00</b> | 6 |

Display with blister

## Telescopic inspection mirror with light



**INCLUDES:**  
  
**2 x CR2032**



- 1** 84x52 mm mirror
- 2** Universal joint for rotation, tilt and fixation
- 3** Ergonomic non-slip handle

| Code          | L mm      | €           |   |
|---------------|-----------|-------------|---|
| <b>121555</b> | 290 / 876 | <b>6,60</b> | 6 |

Display with blister

## Magnetic finger with handle



| Code          | L mm | Ø Magnet | Cap Kg | €            |   |
|---------------|------|----------|--------|--------------|---|
| <b>119135</b> | 510  | 10       | 1      | <b>18,94</b> | 1 |
| <b>119140</b> | 510  | 20       | 3      | <b>22,50</b> | 1 |

## Nylon wire guide

Ø 4 MM NYLON

NO CONDUCTOR



To pass any cable type through conductions

| Code          | L m | €            |   |
|---------------|-----|--------------|---|
| <b>198915</b> | 15  | <b>18,50</b> | 1 |
| <b>198925</b> | 25  | <b>24,30</b> | 1 |

**Trim removal tool**

Cr-V  
STEEL



**Used in trimmings to extract the clamps**

- Chrome plated
- Ergonomic bicomponent handle

| Code          | Ø mm | L mm | €           |   |
|---------------|------|------|-------------|---|
| <b>118015</b> | 8    | 190  | <b>4,80</b> | 6 |
| <b>118020</b> | 10   | 235  | <b>6,26</b> | 6 |

Display with blister

**Trim removal tool kit**



| Code          | No. of items | €            |   |
|---------------|--------------|--------------|---|
| <b>118030</b> | 5            | <b>28,61</b> | 1 |

Display with case

**Nylon lever set**



**Use for removing or unclipping moldings, dashboards and upholstery of vehicles**

| Code          | No. of items | €            |   |
|---------------|--------------|--------------|---|
| <b>118035</b> | 5            | <b>28,07</b> | 1 |

Display with blister

**Bolt extractor set**

Cr-V  
STEEL



- For broken-off screws, bolts and studs

| CONTENTS |         |           |            |
|----------|---------|-----------|------------|
| Nº       | Ø mm    | Ø "       | for metric |
| 1        | 1,4/3,6 | 1/8-1/4   | M3 - M6    |
| 2        | 2,1/4,9 | 1/4-5/16  | M6 - M8    |
| 3        | 3,1/6,5 | 5/16-7/16 | M8 - M11   |
| 4        | 4,8/8,8 | 7/16-9/16 | M11 - M14  |
| 5        | 6,2/11  | 9/16-3/4  | M14 - M18  |

| Code          | No. of items | €            |   |
|---------------|--------------|--------------|---|
| <b>122330</b> | 5            | <b>13,06</b> | 1 |

Display with blister

## 2 leg sliding-leg puller

Cr-V  
STEEL

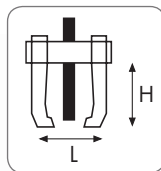

**For safely changing and removing wheels, gears, ball bearings and pulleys**

- One piece drop forged legs for heavy duty jobs
- Spare legs availables

| Code          | H mm | L max. mm | L min mm | €             |   |
|---------------|------|-----------|----------|---------------|---|
| <b>122300</b> | 100  | 85        | 15       | <b>59,34</b>  | 1 |
| <b>122305</b> | 100  | 125       | 15       | <b>65,04</b>  | 1 |
| <b>122310</b> | 150  | 160       | 20       | <b>108,88</b> | 1 |
| <b>122315</b> | 150  | 200       | 20       | <b>159,55</b> | 1 |

## Twin leg reversible puller

Cr-V  
STEEL



- Satin finish legs. Black finish screw.
- Self-centering puller
- Spare legs availables

| Code          | Ø mm | €            |   |
|---------------|------|--------------|---|
| <b>122350</b> | 75   | <b>25,92</b> | 1 |
| <b>122355</b> | 150  | <b>34,92</b> | 1 |
| <b>122360</b> | 200  | <b>56,67</b> | 1 |

## 2 leg multiple puller set

Cr-V  
STEEL

**3 LEG LENGTHS:  
100 / 200 / 250 mm**



Dimensions:380x280x90 mm

### CAPACITY Ø MM

| Use      | min | max |
|----------|-----|-----|
| Internal | 80  | 180 |
| External | 25  | 130 |



**NEW**

**For use as an internal and external extractor**

- End of legs in Cr-V Steel
- Replacement feet available

### CONTENTS

- Forged support 175 mm long
- Center spindle M12 x 150 mm
- 2 forged legs 100 mm long
- 2 forged legs 200 mm long
- 2 forged legs 250 mm long

| Code          | €             |   |
|---------------|---------------|---|
| <b>122365</b> | <b>127,70</b> | 1 |

**Triple leg reversible puller**

Cr-V  
STEEL



- Self centering
- Matte satin finish, puller.
- Black finish spindle
- Replacement feet available

| Code          | Ø mm | €            |   |
|---------------|------|--------------|---|
| <b>122375</b> | 75   | <b>28,38</b> | 1 |
| <b>122380</b> | 150  | <b>50,80</b> | 1 |
| <b>122385</b> | 200  | <b>84,01</b> | 1 |

**3-leg multiple puller set**

Cr-V  
STEEL



**3 LEG LENGTHS:  
100 / 200 / 250 mm**



Dimensions: 440x290x90 mm

**CAPACITY Ø MM**

| Use      | min | max |
|----------|-----|-----|
| Internal | 80  | 180 |
| External | 25  | 130 |

**For use as an internal and external extractor**



- End of legs in Cr-V Steel
- Replacement feet available

**CONTENTS**

- Forged support 175 mm legs
- Center spindle M12 x 150 mm
- 3 forged 100 mm legs
- 3 forged 200 mm legs
- 3 forged 250 mm legs

| Code          | €             |   |
|---------------|---------------|---|
| <b>122390</b> | <b>154,22</b> | 1 |

**2 and 3 leg puller set**

**3 LEG LENGTHS:  
100 / 200 / 250 mm**

**6 PULLERS IN 1**

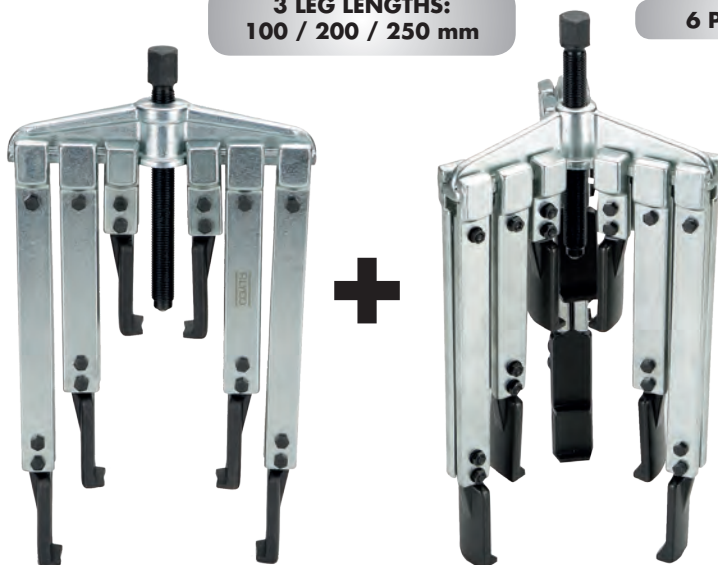

Dimensions: 440x290x90 mm



**CONTENTS**

- Forged support for 2 legs puller
- Forged support for 3 legs puller
- Center spindle M12 x 150 mm
- 3 forged 100 mm legs
- 3 forged 200 mm legs
- 3 forged 250 mm legs

Same features as 122365 and 122390

| Code          | €             |   |
|---------------|---------------|---|
| <b>122395</b> | <b>187,83</b> | 1 |

## Separator and puller set

Cr-V  
STEEL



For the extraction of bearings, gearboxes, pulleys and steering wheels

NEW

### CONTENTS

1 30 x 50 mm guillotine  
1 50 x 75 mm guillotine



| Code   | €     |   |
|--------|-------|---|
| 122200 | 94,25 | 1 |

## Separator

Cr-V  
STEEL



NEW

## Universal ball joint puller

Cr-V  
STEEL



NEW

| Code   | Ø min mm | Ø max mm | €     |   |
|--------|----------|----------|-------|---|
| 122204 | 75       | 105      | 38,86 | 1 |
| 122206 | 100      | 150      | 85,99 | 1 |

| Code   | A min / max | B min / max | €     |   |
|--------|-------------|-------------|-------|---|
| 122220 | 12 / 50     | 18 / 22     | 12,75 | 1 |

## Universal ball joint puller

Cr-V  
STEEL



NEW

## Universal ball joint puller

Cr-V  
STEEL



NEW

| Code   | A min / max | B min / max | €     |   |
|--------|-------------|-------------|-------|---|
| 122225 | 12 / 50     | 20          | 22,10 | 1 |

| Code   | A min / max | B min / max | €     |   |
|--------|-------------|-------------|-------|---|
| 122230 | 60 / 80     | 20          | 28,73 | 1 |

**Multifunction pliers in nylon pouch**



Closed pliers



Open pliers

- Handgrips made in anodised aluminium.
- Supplied with individual nylon pouch.

| Code          | L open mm | €            |   |
|---------------|-----------|--------------|---|
| <b>101260</b> | 160       | <b>17,81</b> | 6 |

**In countertop displayer**

**Multifunction pliers and knife set in nylon pouch**



**KNIFE FEATURES:**

- Blade manufactured in stainless steel
- Foldable blade
- Anodized aluminium handle
- With metallic clip for hanging
- Straight cutting edge



**CONTENTS**

- 101260 - Multifunction pliers
- Knife with aluminium handle
- Nylon pouch

| Code          | No of items | €            |   |
|---------------|-------------|--------------|---|
| <b>101265</b> | 3           | <b>22,22</b> | 6 |

**In countertop displayer**

**Multifunction mini-plier**



**FUNCTIONS:**

- Combination pliers
- Flat nose pliers
- Flat nose (4 mm)
- File
- Wire cutter pliers
- Saw blade
- Phillips tip (PH1)
- Small knife blade
- Tin opener with slotted tip (3 mm)

| Code          | L mm open | L mm closed | €            |   |
|---------------|-----------|-------------|--------------|---|
| <b>101267</b> | 110       | 72          | <b>10,79</b> | 6 |

**In countertop displayer**

## Heavy duty two-hand riveter

30% LESS EFFORT



INCLUDING 4 NOZZLES

### NOZZLES CONTENTS

#### CONTENTS FOR 183105

- Ø 2'4 mm - 3/32"
- Ø 3'2 mm - 1/8"
- Ø 4'0 mm - 5/32"
- Ø 4'8 mm - 3/16"



#### CONTENTS FOR 183115

- Ø 3'2 mm - 1/8"
- Ø 4'0 mm - 5/32"
- Ø 4'8 mm - 3/16"
- Ø 6'4 mm - 1/4"



- Body made of Aluminium
- Bimaterial and ergonomic handles
- Include spanner for nozzles changing
- Four different sizes nozzles included
- Plastic container for used rivets

| Code          | L mm | €            |  |
|---------------|------|--------------|---|
| <b>183105</b> | 300  | <b>35,77</b> | 1   |
| <b>183115</b> | 325  | <b>49,40</b> | 1   |

## Heavy duty hand riveter set

INCLUDING 4 NOZZLES,  
RIVETS AND  
WASHERS



Dimensions: 325x155x55 mm

### CONTENTS:

- 1 riveter with four nozzles: 2.4 - 3.2 - 4.0 - 4.8 mm
- 80 rivets:
  - 20 of 2.4 mm
  - 20 of 3.2 mm
  - 20 of 4.0 mm
  - 20 of 4.8 mm
- 20 washers:
  - 5 of 2.4 mm
  - 5 of 3.2 mm
  - 5 of 4.0 mm
  - 5 of 4.8 mm

- Made of Aluminum alloy
- Drop forged movable handle
- Ergonomic handle
- Safety latch
- Steel made nozzles

| Code          | L mm | €            |  |
|---------------|------|--------------|---|
| <b>183100</b> | 250  | <b>31,89</b> | 1   |

Display in plastic box

## Two-hand lever riveter

INCLUDING 4 NOZZLES  
3,2-4,0-4,8-6,4 MM



- Made of Aluminum alloy
- Steel made nozzles
- Four different sizes nozzles
- Ergonomic handles made of soft rubber
- Steel tube handle. Very light
- Include spanner for nozzles changing
- Plastic container for used rivets

| Code          | L mm | €            |  |
|---------------|------|--------------|---|
| <b>183110</b> | 450  | <b>60,23</b> | 1   |

**Extendable riveting plier**

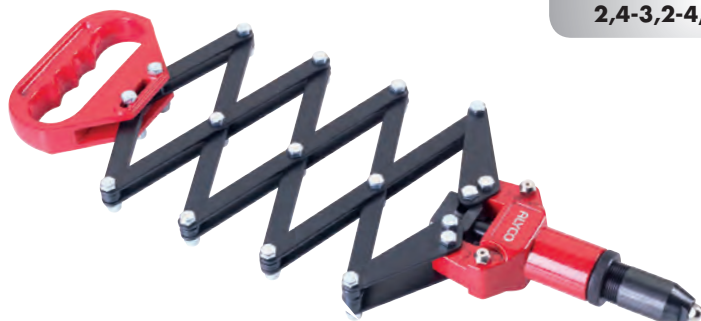

**INCLUDING 4 NOZZLES**  
2,4-3,2-4,0-4,8 MM

- Body made in aluminium.
- Runner arm with 4 steel rivets.
- Ergonomic handle made in aluminium.
- Steel made nozzles

| Code          | L mm<br>min. max. | €            |   |
|---------------|-------------------|--------------|---|
| <b>183130</b> | 320 850           | <b>74,55</b> | 1 |

**Blind nut riveter set**



Dimensions: 325 x 155 x 55 mm

**CONTENTS**

- 1 blind nut pliers
- 4 nuts for M3, M4, M5, M6
- 40 nuts: 10 - M3 / 10 - M4 / 10 - M5 / 10 - M6

- Body made in aluminium.
- PVC covered ergonomic handgrips.
- Safety latch.

| Code          | L mm | €            |   |
|---------------|------|--------------|---|
| <b>183125</b> | 250  | <b>48,88</b> | 1 |

**2 handed blind nut riveter**



**INCLUDING 4 MOUTHS FOR NOSES M5, M6, M8, M10**

- Body made in aluminium.
- Ergonomic handgrips in soft rubber
- Tubular handles made in steel

| Code          | L mm | €            |   |
|---------------|------|--------------|---|
| <b>183120</b> | 450  | <b>80,58</b> | 1 |

**Spare mouths for rivets**

**FOR 183125**



| Code          | Ø M | L mm | €           |   |
|---------------|-----|------|-------------|---|
| <b>183126</b> | M3  | 115  | <b>3,41</b> | 1 |
| <b>183127</b> | M4  | 115  | <b>3,41</b> | 1 |
| <b>183128</b> | M5  | 115  | <b>3,41</b> | 1 |
| <b>183129</b> | M6  | 115  | <b>3,41</b> | 1 |

**FOR 183120**



| Code          | Ø M | L mm | €           |   |
|---------------|-----|------|-------------|---|
| <b>183121</b> | M5  | 70   | <b>4,48</b> | 1 |
| <b>183122</b> | M6  | 70   | <b>4,48</b> | 1 |
| <b>183123</b> | M8  | 70   | <b>4,48</b> | 1 |
| <b>183124</b> | M10 | 70   | <b>4,48</b> | 1 |

## Oil filter wrench



**For extraction of oil filters**



| Code          | Ø Filter | L mm | €            |   |
|---------------|----------|------|--------------|---|
| <b>198852</b> | 65-110   | 240  | <b>19,30</b> | 6 |
| <b>198857</b> | 110-155  | 280  | <b>22,54</b> | 6 |

Display with blister

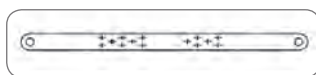

Thickness 0.60 mm / width 12 mm

### SPARE STRAP

| Code          | Ø Filter | €           |   |
|---------------|----------|-------------|---|
| <b>198851</b> | 65-110   | <b>2,60</b> | 6 |
| <b>198856</b> | 110-155  | <b>2,85</b> | 6 |

Valid for 198852, 198857, 198850, 198855

## Oil filter wrench



- Knurled screw Ø 40 mm
- Aluminum body
- Rough painted aluminum finish
- Replacement steel strap available

| Code          | Ø Filter | L mm | €            |   |
|---------------|----------|------|--------------|---|
| <b>198850</b> | 65-110   | 215  | <b>13,15</b> | 6 |
| <b>198855</b> | 110-155  | 260  | <b>15,39</b> | 6 |

Display with blister

## 3-leg oil filter wrench

Cr-V STEEL



**FOR FILTERS 63-120 MM**

**FOR 3/8" - 1/2"**

**ROUND LEG Ø 10 MM**

- Includes adapter 1/2" F x 3/8" M

| Code          | Dimensions mm | €            |   |
|---------------|---------------|--------------|---|
| <b>122255</b> | 80x80x100     | <b>19,00</b> | 1 |

Display with blister

## 3-leg filter wrench

Cr-V STEEL



**FOR FILTERS 63-102 MM**

**FLAT LEG 13 X 4 MM**

| Code          | Dimensions mm | €            |   |
|---------------|---------------|--------------|---|
| <b>122250</b> | 80x80x47      | <b>11,00</b> | 1 |

**Electric welder**



Replacement Tips

**Desoldering pump**



**Suitable for electronic works**

• Nickel coated tip for all electronic appliance use

| Code             | Power W         | Ø bit | €            |   |
|------------------|-----------------|-------|--------------|---|
| <b>190580</b>    | 30              | 4     | <b>12,59</b> | 1 |
| <b>190590</b>    | 60              | 6     | <b>14,53</b> | 1 |
| <b>190596</b>    | 80              | 8     | <b>19,55</b> | 1 |
| REPLACEMENT TIPS |                 |       |              |   |
| <b>190581</b>    | for code 190580 |       | <b>1,70</b>  | 1 |
| <b>190591</b>    | for code 190590 |       | <b>1,90</b>  | 1 |
| <b>190597</b>    | for code 190596 |       | <b>2,10</b>  | 1 |

Display with blister

**USE**

Suction of the liquid by pressing the end

| Code          | Dimensions mm | €           |   |
|---------------|---------------|-------------|---|
| <b>190595</b> | 200x20        | <b>7,72</b> | 1 |

Display with blister

**Hot glue gun**

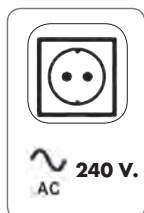

Includes 2 glue bars  
11,2x200mm



**INSTRUCTIONS OF USE**

- Insert a glue bar in to the back of the gun
- Preheat between 3 -5 minutes
- Press the trigger and apply the glue

**USE:**

- Wood - Carton
- Plastic - Ceramics
- Light Metal - Fabric

- Dispensing trigger with flow control
- Anti-drip nozzle

| Code          | €           |   |
|---------------|-------------|---|
| <b>198892</b> | <b>9,30</b> | 6 |



**Glue sticks**

Translucent



Dimensions: 11,2x200mm  
Weigh: 20 gr.

- Resin Eva material
- Each bag includes 10 glue sticks

| Code          | No of items | €           |    |
|---------------|-------------|-------------|----|
| <b>198895</b> | 10          | <b>4,90</b> | 20 |

Display in bag with hanger

## Heavy duty caulking gun

FORCE RATIO

**18:1**

ANTI DRIP



FOR  
310 ML  
CARTRIDGES

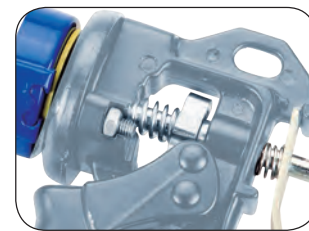

Reinforced rod 9 mm thick

**Suitable for high viscosity resins and glues**

- Caulking gun of cilindric rod
- Reinforced trigger housing
- Trigger made of high quality Aluminium

| Code          | L mm | D mm | €            |   |
|---------------|------|------|--------------|---|
| <b>198807</b> | 225  | 50   | <b>14,00</b> | 6 |

## Reinforced caulking gun

FORCE RATIO

**12:1**

ANTI DRIP



FOR  
310 ML  
CARTRIDGES

**Suitable for half density glues**

- Caulking gun of cilindric rod
- Reinforced trigger housing
- Trigger made of high quality Aluminium

| Code          | L mm | D mm | €           |    |
|---------------|------|------|-------------|----|
| <b>198805</b> | 250  | 50   | <b>6,33</b> | 12 |

## High-power mortar applicator

FORCE RATIO

**24:1**

ANTI DRIP



FOR 310, 400 AND 600 ML  
CARTRIDGES

**NEW**

**Suitable for high density mortar**

- 1 Aluminum frames
- 2 Perforated rod Ø 7.8 mm
- 3 3.5 mm metal inner plate
- 4 Reinforced aluminum handle



Reinforced rod 9 mm thick

| Code          | L mm | D mm | €            |   |
|---------------|------|------|--------------|---|
| <b>198818</b> | 380  | 50   | <b>17,73</b> | 2 |

Spare nozzles on next page

**Standard caulking gun**

**FORCE RATIO  
12:1**



198815

**FOR 310, 400 AND 600 ML CARTRIDGES**



198810

**FOR  
310 ML  
CARTRIDGES**



- Cilinder in Aluminium
- Includes nozzles

**Suitable for half density**



198816  
Spare nozzles

| Code          | L mm               | D mm | €            |    |
|---------------|--------------------|------|--------------|----|
| <b>198810</b> | 250                | 50   | <b>8,90</b>  | 2  |
| <b>198815</b> | 380                | 50   | <b>10,67</b> | 2  |
| SPARE NOZZLES |                    |      |              |    |
| <b>198816</b> | For 198810/815/818 |      | <b>1,00</b>  | 12 |

**Polyurethane foam caulking gun**

**STAINLESS  
STEEL NOZZLE**



**For application of  
polyurethane foam**

- Zinc body
- Ergonomically shaped hard plastic handle
- Supplied with 2 tip guards

| Code          | L mm | €            |   |
|---------------|------|--------------|---|
| <b>198820</b> | 350  | <b>18,00</b> | 2 |

**Teflon coated polyurethane foam caulking**

**STAINLESS  
STEEL NOZZLE**



**For application of  
polyurethane foam**

**TEFLON (PTFE)  
COATED NOZZLE**

- Reinforced aluminum body
- Teflon coated
- Ergonomic foam adjustment screw
- Supplied with 2 tip guards

| Code          | L mm | €            |   |
|---------------|------|--------------|---|
| <b>198821</b> | 350  | <b>23,60</b> | 2 |

## Lever grease gun

MAXIMUM PRESSURE  
  
**500 BAR**

| CAPACITY  |        |
|-----------|--------|
| CARTRIDGE | BULK   |
| 400 cc    | 500 cc |

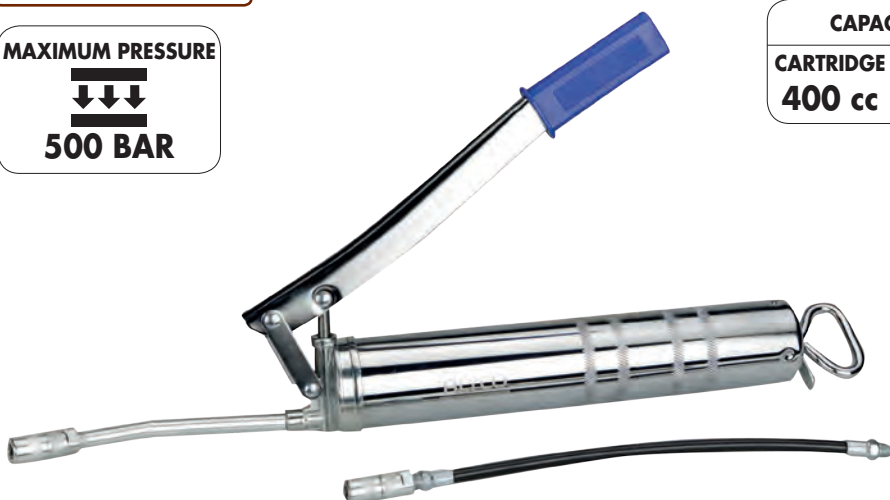

- Chromed body
- Lever with ergonomic grip
- With screw for air bleeding

### CONTENTS

- 1 Rigid 150 mm / 6" hose
- 1 Flexible 300 mm / 12" hose 198861
- 2 hydraulic nozzles 198863

| Code          | L mm | €            |  |
|---------------|------|--------------|---|
| <b>198860</b> | 400  | <b>17,80</b> | 1   |

### ACCESSORIES

| Code          | L mm | €           |  |
|---------------|------|-------------|---|
| <b>198861</b> | 300  | <b>1,60</b> | 1   |
| <b>198863</b> | 38   | <b>1,60</b> | 1   |

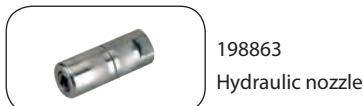

## Oil syringe

### USE:

- For transmissions, differentials, gearboxes,...



For transferring any non-corrosive liquid

- Includes flexible tube 300 mm long

| Code          | L mm | €            |  |
|---------------|------|--------------|---|
| <b>198865</b> | 400  | <b>12,44</b> | 1   |

Display in individual case

## Manual transfer pump

FOR DRUMS  
60-200 L

DELIVERY 14 L/MIN



EXTENDABLE  
  
 457 mm  
 890 mm



For transferring all types of non-corrosive liquids

- Connection to drum M2 "G"
- Made of Steel and Aluminum

| Code          | L mm    | €            |  |
|---------------|---------|--------------|---|
| <b>198885</b> | 457/890 | <b>32,74</b> | 1   |

**Jerrycan**



198875



20 L



198876



198870

10 L



- Approved UN Standard, for the transportation of hydrocarbons
- Made of 0.8 mm steel sheet
- Special anti-leak lock
- Supplied with flexible nozzle

| Code          | L  | Dimensions mm | €            |   |
|---------------|----|---------------|--------------|---|
| <b>198870</b> | 10 | 350x170x290   | <b>28,66</b> | 1 |
| <b>198875</b> | 20 | 350x170x470   | <b>33,66</b> | 1 |

**ACCESSORIES**

|               |                 |             |   |
|---------------|-----------------|-------------|---|
| <b>198876</b> | Flexible nozzle | <b>7,34</b> | 1 |
|---------------|-----------------|-------------|---|

**Oil can**



198882



198880



- Supplied with 2 spouts:  
120 mm flexible spout and 120 mm rigid spout
- Made of 0.8 mm steel sheet

| Code          | Capacity cc | Ø mm | €           |   |
|---------------|-------------|------|-------------|---|
| <b>198880</b> | 300         | 70   | <b>4,90</b> | 1 |
| <b>198882</b> | 500         | 80   | <b>5,60</b> | 1 |

**Paint mixing paddle**



**To mix paints, varnishes, etc.**

- Hexagonal rod and strip made in steel
- Painted finish
- Supplied with rubber hanger

| Code          | Ø head mm | L mm | Ø shank mm | €           |   |
|---------------|-----------|------|------------|-------------|---|
| <b>198826</b> | 60        | 400  | 8          | <b>2,28</b> | 6 |
| <b>198828</b> | 80        | 400  | 8          | <b>2,46</b> | 6 |
| <b>198830</b> | 100       | 600  | 10         | <b>3,63</b> | 6 |
| <b>198832</b> | 120       | 600  | 14         | <b>5,50</b> | 6 |

**Paint mixing paddle**

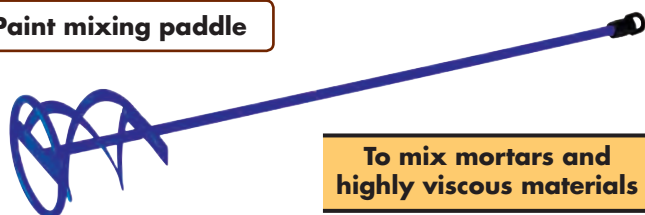

**To mix mortars and highly viscous materials**

- Hexagonal rod and strip made in steel
- Painted finish
- Supplied with rubber hanger

| Code          | Ø head mm | L mm | Handle connexion | €            |   |
|---------------|-----------|------|------------------|--------------|---|
| <b>198835</b> | 100       | 600  | M14              | <b>11,91</b> | 6 |

## Wall displayer

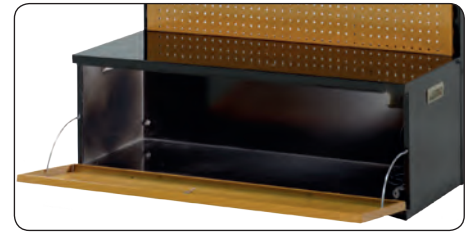

Bottom drawer with lock

- With fluorescent bulb at header
- Lower loading drawer

| WALL DISPLAYER |               |               |
|----------------|---------------|---------------|
| Code           | Dimensions mm | €             |
| <b>113503</b>  | 1000x450x2280 | <b>370,72</b> |

Includes 60 single hooks code 113504

## Hooks



| SINGLE HOOK   |               |             |
|---------------|---------------|-------------|
| Code          | Dimensions mm | €           |
| <b>113504</b> | 200x5         | <b>1,72</b> |



| HOOK FOR PLIERS |               |             |
|-----------------|---------------|-------------|
| Code            | Dimensions mm | €           |
| <b>113536</b>   | 200x6         | <b>7,42</b> |

- Body made of 1 mm sheet metal
- 250 mm deep support foot
- Valid for all hooks

| Code          | Dimensions mm | €             |
|---------------|---------------|---------------|
| <b>113534</b> | 350x750       | <b>112,69</b> |

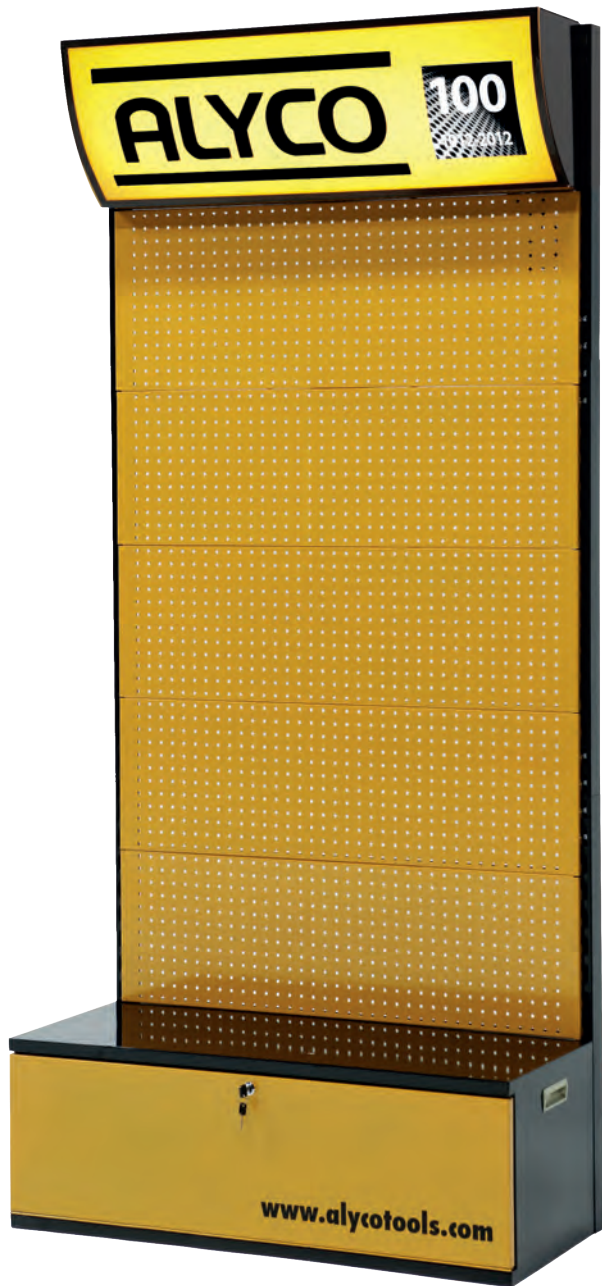

## Multitool displayer



# CODE-PAGE INDEX

| Code   | Page | Code   | Page | Code   | Page | Code   | Page | Code   | Page | Code   | Page | Code   | Page | Code   | Page |
|--------|------|--------|------|--------|------|--------|------|--------|------|--------|------|--------|------|--------|------|
| 101200 | 48   | 108006 | 65   | 109102 | 55   | 111536 | 225  | 119030 | 116  | 119322 | 124  | 120825 | 188  | 122117 | 190  |
| 101201 | 48   | 108013 | 66   | 109103 | 55   | 111537 | 225  | 119031 | 116  | 119330 | 125  | 120850 | 188  | 122118 | 190  |
| 101202 | 48   | 108015 | 66   | 109104 | 55   | 111538 | 224  | 119032 | 116  | 119331 | 125  | 120875 | 188  | 122119 | 190  |
| 101203 | 48   | 108020 | 66   | 109105 | 55   | 111540 | 225  | 119033 | 116  | 119332 | 127  | 120900 | 188  | 122120 | 190  |
| 101206 | 47   | 108030 | 69   | 110301 | 49   | 111545 | 225  | 119035 | 117  | 119335 | 125  | 120925 | 188  | 122126 | 190  |
| 101208 | 47   | 108032 | 68   | 110302 | 49   | 111550 | 225  | 119036 | 117  | 119336 | 127  | 120950 | 188  | 122128 | 190  |
| 101209 | 47   | 108034 | 68   | 110303 | 49   | 111551 | 225  | 119038 | 117  | 119338 | 127  | 120975 | 188  | 122130 | 190  |
| 101210 | 49   | 108035 | 67   | 110304 | 47   | 113142 | 57   | 119039 | 117  | 119339 | 127  | 121000 | 188  | 122132 | 190  |
| 101217 | 49   | 108040 | 66   | 110305 | 47   | 113144 | 57   | 119040 | 116  | 119340 | 125  | 121025 | 188  | 122134 | 190  |
| 101218 | 54   | 108046 | 61   | 110309 | 49   | 113155 | 56   | 119041 | 116  | 119344 | 124  | 121050 | 188  | 122136 | 190  |
| 101220 | 54   | 108048 | 61   | 110310 | 49   | 113160 | 57   | 119042 | 116  | 119345 | 124  | 121075 | 188  | 122146 | 190  |
| 101222 | 54   | 108052 | 61   | 110311 | 49   | 113165 | 56   | 119043 | 116  | 119346 | 124  | 121100 | 188  | 122148 | 190  |
| 101250 | 15   | 108055 | 61   | 110320 | 59   | 113170 | 56   | 119049 | 118  | 119347 | 124  | 121125 | 188  | 122150 | 190  |
| 101260 | 257  | 108060 | 61   | 110322 | 59   | 113175 | 56   | 119050 | 118  | 119348 | 124  | 121150 | 188  | 122152 | 190  |
| 101265 | 257  | 108075 | 63   | 111100 | 49   | 113180 | 56   | 119051 | 123  | 119349 | 124  | 121175 | 188  | 122154 | 190  |
| 101267 | 257  | 108080 | 61   | 111101 | 49   | 113185 | 56   | 119052 | 123  | 119350 | 124  | 121200 | 188  | 122156 | 190  |
| 101270 | 68   | 108081 | 61   | 111199 | 50   | 113190 | 57   | 119055 | 118  | 119351 | 124  | 121225 | 188  | 122170 | 191  |
| 101272 | 68   | 108085 | 61   | 111200 | 50   | 113192 | 57   | 119057 | 119  | 119352 | 124  | 121250 | 188  | 122180 | 191  |
| 101274 | 69   | 108086 | 61   | 111201 | 50   | 113194 | 57   | 119058 | 119  | 119353 | 124  | 121275 | 188  | 122200 | 256  |
| 101276 | 69   | 108090 | 69   | 111212 | 219  | 113195 | 57   | 119060 | 119  | 119361 | 126  | 121300 | 188  | 122204 | 256  |
| 101300 | 48   | 108095 | 69   | 111214 | 219  | 113489 | 31   | 119074 | 117  | 119362 | 126  | 121310 | 189  | 122206 | 256  |
| 101301 | 48   | 108100 | 70   | 111218 | 219  | 113499 | 32   | 119075 | 117  | 119363 | 126  | 121320 | 188  | 122220 | 256  |
| 101302 | 48   | 108105 | 70   | 111224 | 219  | 113503 | 266  | 119076 | 117  | 119364 | 126  | 121330 | 188  | 122225 | 256  |
| 101303 | 47   | 108110 | 70   | 111236 | 219  | 113504 | 266  | 119077 | 117  | 119365 | 126  | 121335 | 189  | 122230 | 256  |
| 101304 | 47   | 108120 | 70   | 111308 | 219  | 113534 | 266  | 119078 | 117  | 119366 | 126  | 121350 | 189  | 122250 | 260  |
| 101310 | 48   | 108125 | 67   | 111310 | 219  | 113536 | 266  | 119079 | 117  | 119367 | 126  | 121500 | 25   | 122255 | 260  |
| 101312 | 47   | 108210 | 66   | 111312 | 219  | 113610 | 14   | 119080 | 117  | 119368 | 126  | 121510 | 25   | 122300 | 254  |
| 101400 | 17   | 108215 | 66   | 111314 | 219  | 113612 | 14   | 119081 | 117  | 119369 | 126  | 121518 | 25   | 122305 | 254  |
| 101402 | 17   | 108250 | 222  | 111318 | 219  | 114001 | 58   | 119082 | 117  | 119370 | 126  | 121524 | 25   | 122310 | 254  |
| 101410 | 17   | 108255 | 222  | 111324 | 219  | 114002 | 58   | 119083 | 117  | 119371 | 126  | 121530 | 117  | 122315 | 254  |
| 101450 | 18   | 108260 | 222  | 111330 | 221  | 114003 | 58   | 119084 | 117  | 119372 | 126  | 121550 | 252  | 122330 | 253  |
| 101460 | 18   | 108265 | 222  | 111336 | 219  | 114005 | 58   | 119085 | 119  | 119373 | 126  | 121555 | 252  | 122340 | 189  |
| 101801 | 52   | 108300 | 71   | 111338 | 221  | 114006 | 58   | 119090 | 118  | 119375 | 126  | 122003 | 190  | 122342 | 189  |
| 101802 | 52   | 108302 | 71   | 111339 | 221  | 114007 | 58   | 119091 | 116  | 119501 | 122  | 122004 | 190  | 122345 | 189  |
| 101803 | 52   | 108315 | 67   | 111340 | 220  | 114008 | 58   | 119092 | 116  | 119502 | 122  | 122005 | 190  | 122347 | 189  |
| 101804 | 51   | 108330 | 67   | 111341 | 220  | 114010 | 58   | 119093 | 116  | 119503 | 122  | 122006 | 190  | 122350 | 254  |
| 101805 | 51   | 108335 | 67   | 111342 | 220  | 114015 | 58   | 119094 | 116  | 119515 | 122  | 122007 | 190  | 122355 | 254  |
| 101810 | 52   | 108340 | 67   | 111343 | 220  | 114016 | 58   | 119095 | 116  | 119525 | 122  | 122008 | 190  | 122360 | 254  |
| 101811 | 52   | 108350 | 67   | 111344 | 221  | 114017 | 58   | 119096 | 116  | 119529 | 122  | 122009 | 190  | 122365 | 254  |
| 101812 | 51   | 108352 | 64   | 111345 | 221  | 114018 | 58   | 119097 | 116  | 119530 | 122  | 122010 | 190  | 122375 | 255  |
| 101813 | 51   | 108355 | 64   | 111346 | 221  | 115105 | 50   | 119098 | 116  | 119531 | 122  | 122011 | 190  | 122380 | 255  |
| 101815 | 52   | 108356 | 64   | 111347 | 221  | 115115 | 50   | 119099 | 119  | 119535 | 122  | 122012 | 190  | 122385 | 255  |
| 101821 | 52   | 108360 | 64   | 111350 | 221  | 115120 | 50   | 119100 | 120  | 119536 | 122  | 122013 | 190  | 122390 | 255  |
| 101822 | 52   | 108361 | 64   | 111352 | 221  | 115125 | 50   | 119102 | 121  | 119537 | 122  | 122014 | 190  | 122395 | 255  |
| 101823 | 51   | 108364 | 64   | 111355 | 220  | 115130 | 50   | 119105 | 121  | 119538 | 122  | 122015 | 190  | 123000 | 234  |
| 101824 | 51   | 108366 | 64   | 111360 | 220  | 115135 | 50   | 119107 | 120  | 119539 | 122  | 122016 | 190  | 123001 | 234  |
| 101825 | 52   | 108367 | 64   | 111365 | 220  | 115140 | 50   | 119110 | 120  | 119540 | 122  | 122018 | 190  | 123005 | 234  |
| 101826 | 52   | 108368 | 64   | 111370 | 220  | 118001 | 213  | 119115 | 120  | 120100 | 188  | 122020 | 190  | 123010 | 60   |
| 101830 | 53   | 108369 | 64   | 111375 | 220  | 118002 | 213  | 119117 | 121  | 120125 | 188  | 122022 | 190  | 123031 | 60   |
| 101835 | 53   | 108370 | 62   | 111380 | 220  | 118003 | 213  | 119120 | 121  | 120150 | 188  | 122036 | 190  | 123032 | 60   |
| 101840 | 53   | 108375 | 63   | 111385 | 220  | 118004 | 213  | 119125 | 121  | 120175 | 188  | 122038 | 190  | 123033 | 60   |
| 101845 | 53   | 108377 | 63   | 111390 | 220  | 118005 | 213  | 119130 | 121  | 120200 | 188  | 122040 | 190  | 123034 | 60   |
| 101848 | 53   | 108380 | 65   | 111410 | 219  | 118006 | 213  | 119132 | 234  | 120225 | 188  | 122046 | 190  | 123036 | 60   |
| 101860 | 53   | 108390 | 62   | 111412 | 219  | 118007 | 213  | 119134 | 234  | 120250 | 188  | 122048 | 190  | 123037 | 60   |
| 101862 | 51   | 108392 | 62   | 111414 | 219  | 118010 | 213  | 119135 | 252  | 120275 | 188  | 122050 | 190  | 123038 | 60   |
| 102201 | 48   | 108395 | 71   | 111418 | 219  | 118015 | 253  | 119140 | 252  | 120300 | 188  | 122052 | 190  | 123110 | 60   |
| 104101 | 48   | 108400 | 196  | 111424 | 219  | 118020 | 253  | 119150 | 114  | 120325 | 188  | 122054 | 190  | 123111 | 60   |
| 106202 | 54   | 108405 | 196  | 111436 | 219  | 118030 | 253  | 119155 | 120  | 120350 | 188  | 122056 | 190  | 123112 | 60   |
| 106203 | 54   | 108410 | 196  | 111445 | 71   | 118035 | 253  | 119200 | 115  | 120375 | 188  | 122058 | 190  | 123113 | 60   |
| 106204 | 54   | 108415 | 195  | 111501 | 224  | 118050 | 89   | 119205 | 115  | 120400 | 188  | 122060 | 190  | 123114 | 60   |
| 106206 | 54   | 108420 | 195  | 111502 | 224  | 118052 | 89   | 119206 | 115  | 120425 | 188  | 122062 | 190  | 123120 | 60   |
| 106207 | 54   | 108425 | 195  | 111503 | 224  | 118054 | 89   | 119208 | 115  | 120450 | 188  | 122070 | 191  | 123200 | 59   |
| 106208 | 54   | 108490 | 196  | 111504 | 224  | 119004 | 116  | 119210 | 118  | 120475 | 188  | 122080 | 191  | 123210 | 59   |
| 106209 | 54   | 108492 | 196  | 111505 | 224  | 119005 | 116  | 119231 | 115  | 120500 | 188  | 122104 | 190  | 123215 | 59   |
| 106210 | 54   | 108505 | 198  | 111506 | 224  | 119006 | 116  | 119232 | 115  | 120525 | 188  | 122105 | 190  | 125001 | 177  |
| 106211 | 54   | 108510 | 198  | 111507 | 224  | 119008 | 116  | 119241 | 115  | 120550 | 188  | 122106 | 190  | 125002 | 177  |
| 106212 | 54   | 108520 | 197  | 111510 | 224  | 119010 | 116  | 119242 | 115  | 120575 | 188  | 122107 | 190  | 125003 | 177  |
| 106213 | 54   | 108525 | 197  | 111511 | 224  | 119012 | 117  | 119303 | 124  | 120600 | 188  | 122108 | 190  | 125004 | 177  |
| 106214 | 54   | 108530 | 197  | 111513 | 223  | 119014 | 117  | 119304 | 124  | 120625 | 188  | 122109 | 190  | 125005 | 177  |
| 106220 | 54   | 108550 | 199  | 111514 | 223  | 119016 | 117  | 119305 | 124  | 120650 | 188  | 122110 | 190  | 125007 | 177  |
| 106225 | 54   | 108555 | 199  | 111520 | 223  | 119018 | 117  | 119306 | 124  | 120675 | 188  | 122111 | 190  | 125008 | 177  |
| 106230 | 54   | 108560 | 199  | 111522 | 225  | 119022 | 116  | 119308 | 124  | 120700 | 188  | 122112 | 190  | 125009 | 177  |
| 106235 | 54   | 109007 | 55   | 111524 | 225  | 119023 | 116  | 119310 | 124  | 120725 | 188  | 122113 | 190  | 125010 | 177  |
| 107101 | 48   | 109009 | 55   | 111525 | 223  | 119024 | 116  | 119311 | 124  | 120750 | 188  | 122114 | 190  | 125011 | 177  |
| 108002 | 65   | 109015 | 55   | 111534 | 224  | 119025 | 116  | 119312 | 124  | 120775 | 188  | 122115 | 190  | 125012 | 177  |
| 108003 | 65   | 109101 | 55   | 111535 | 224  | 119029 | 116  | 119321 | 124  | 120800 | 188  | 122116 | 190  | 125013 | 177  |

# CODE-PAGE INDEX

| Code   | Page | Code   | Page | Code   | Page | Code   | Page | Code   | Page | Code   | Page | Code   | Page | Code   | Page | Code | Page |
|--------|------|--------|------|--------|------|--------|------|--------|------|--------|------|--------|------|--------|------|------|------|
| 125014 | 177  | 136008 | 191  | 144046 | 173  | 175018 | 89   | 186187 | 141  | 190216 | 139  | 190419 | 139  | 190604 | 24   |      |      |
| 125015 | 177  | 136009 | 191  | 144055 | 172  | 175019 | 89   | 190002 | 73   | 190218 | 139  | 190420 | 139  | 190610 | 24   |      |      |
| 125016 | 177  | 136010 | 191  | 144065 | 172  | 175020 | 89   | 190004 | 73   | 190220 | 139  | 190421 | 139  | 190615 | 24   |      |      |
| 125017 | 177  | 136011 | 191  | 144075 | 172  | 175021 | 89   | 190006 | 73   | 190222 | 139  | 190422 | 139  | 190620 | 24   |      |      |
| 125019 | 177  | 136012 | 191  | 144086 | 172  | 175022 | 89   | 190008 | 73   | 190224 | 139  | 190423 | 139  | 190621 | 24   |      |      |
| 125020 | 177  | 136013 | 191  | 144087 | 172  | 175023 | 89   | 190010 | 73   | 190226 | 139  | 190424 | 139  | 190622 | 24   |      |      |
| 125021 | 177  | 136014 | 191  | 144088 | 172  | 175024 | 89   | 190012 | 73   | 190228 | 139  | 190427 | 139  | 190623 | 24   |      |      |
| 125022 | 177  | 136205 | 191  | 144092 | 198  | 175025 | 89   | 190014 | 73   | 190230 | 139  | 190430 | 139  | 190705 | 143  |      |      |
| 125023 | 177  | 136208 | 191  | 144093 | 171  | 175026 | 89   | 190016 | 73   | 190240 | 137  | 190432 | 139  | 190706 | 143  |      |      |
| 125024 | 177  | 138001 | 192  | 144097 | 198  | 175027 | 89   | 190018 | 73   | 190250 | 131  | 190433 | 140  | 190707 | 143  |      |      |
| 125035 | 177  | 138002 | 192  | 144098 | 173  | 175030 | 89   | 190020 | 73   | 190252 | 131  | 190442 | 106  | 190708 | 143  |      |      |
| 125036 | 177  | 138003 | 192  | 144099 | 173  | 183100 | 258  | 190022 | 73   | 190254 | 131  | 190443 | 106  | 190710 | 143  |      |      |
| 125037 | 177  | 138004 | 165  | 145101 | 94   | 183105 | 258  | 190024 | 73   | 190256 | 131  | 190444 | 106  | 190712 | 143  |      |      |
| 125038 | 177  | 138005 | 165  | 145102 | 94   | 183110 | 258  | 190026 | 73   | 190258 | 131  | 190445 | 106  | 190720 | 142  |      |      |
| 125039 | 177  | 138006 | 165  | 145103 | 94   | 183115 | 258  | 190028 | 73   | 190260 | 131  | 190446 | 106  | 190725 | 142  |      |      |
| 125040 | 177  | 138007 | 165  | 145104 | 94   | 183120 | 259  | 190030 | 73   | 190262 | 131  | 190448 | 106  | 190727 | 142  |      |      |
| 125050 | 177  | 138008 | 165  | 145105 | 94   | 183121 | 259  | 190040 | 74   | 190264 | 131  | 190450 | 100  | 190730 | 142  |      |      |
| 125060 | 177  | 138010 | 192  | 145106 | 94   | 183122 | 259  | 190045 | 74   | 190266 | 131  | 190451 | 100  | 190740 | 142  |      |      |
| 125501 | 177  | 138011 | 192  | 145107 | 94   | 183123 | 259  | 190050 | 78   | 190268 | 131  | 190452 | 100  | 190741 | 143  |      |      |
| 125601 | 177  | 138012 | 192  | 145108 | 94   | 183124 | 259  | 190052 | 78   | 190270 | 131  | 190453 | 100  | 190745 | 142  |      |      |
| 131002 | 193  | 138013 | 192  | 145109 | 94   | 183125 | 259  | 190054 | 78   | 190280 | 131  | 190454 | 100  | 190746 | 143  |      |      |
| 131004 | 193  | 138014 | 192  | 145110 | 94   | 183126 | 259  | 190056 | 78   | 190282 | 131  | 190455 | 100  | 190750 | 142  |      |      |
| 131006 | 193  | 138021 | 165  | 149001 | 235  | 183127 | 259  | 190058 | 78   | 190284 | 131  | 190456 | 100  | 190751 | 143  |      |      |
| 131008 | 193  | 140001 | 235  | 149002 | 235  | 183128 | 259  | 190060 | 78   | 190286 | 131  | 190457 | 100  | 190755 | 142  |      |      |
| 131010 | 193  | 140002 | 235  | 149003 | 235  | 183129 | 259  | 190062 | 78   | 190288 | 131  | 190458 | 100  | 190756 | 143  |      |      |
| 131011 | 193  | 140003 | 235  | 149004 | 235  | 183130 | 259  | 190064 | 78   | 190290 | 131  | 190460 | 102  | 190760 | 142  |      |      |
| 131012 | 193  | 140004 | 235  | 149050 | 235  | 183300 | 36   | 190066 | 78   | 190295 | 129  | 190461 | 102  | 190761 | 143  |      |      |
| 131014 | 193  | 140005 | 235  | 149055 | 235  | 183310 | 36   | 190068 | 78   | 190300 | 145  | 190462 | 102  | 190765 | 142  |      |      |
| 131016 | 193  | 140006 | 235  | 149081 | 235  | 183350 | 35   | 190070 | 78   | 190302 | 144  | 190463 | 102  | 190767 | 143  |      |      |
| 131018 | 193  | 140007 | 235  | 149086 | 235  | 183352 | 35   | 190072 | 78   | 190305 | 145  | 190464 | 102  | 190768 | 143  |      |      |
| 131020 | 193  | 140008 | 235  | 149087 | 235  | 183354 | 35   | 190074 | 78   | 190310 | 145  | 190465 | 102  | 190770 | 143  |      |      |
| 131022 | 193  | 140009 | 235  | 151001 | 193  | 183356 | 35   | 190076 | 78   | 190311 | 145  | 190466 | 102  | 190771 | 143  |      |      |
| 131024 | 193  | 140010 | 235  | 164021 | 94   | 183360 | 39   | 190078 | 78   | 190312 | 145  | 190467 | 102  | 190774 | 143  |      |      |
| 131031 | 193  | 140011 | 235  | 164022 | 94   | 183370 | 39   | 190090 | 79   | 190313 | 145  | 190468 | 102  | 190775 | 143  |      |      |
| 131032 | 193  | 140012 | 165  | 164023 | 94   | 186100 | 114  | 190095 | 79   | 190314 | 145  | 190477 | 86   | 190776 | 143  |      |      |
| 131033 | 193  | 140013 | 165  | 164024 | 94   | 186104 | 112  | 190100 | 76   | 190317 | 145  | 190478 | 86   | 190777 | 143  |      |      |
| 131110 | 193  | 140014 | 165  | 164025 | 94   | 186105 | 112  | 190102 | 76   | 190319 | 145  | 190479 | 86   | 190824 | 80   |      |      |
| 131112 | 193  | 140015 | 165  | 172250 | 92   | 186106 | 112  | 190104 | 76   | 190322 | 145  | 190480 | 86   | 190827 | 80   |      |      |
| 131114 | 193  | 140016 | 165  | 172251 | 92   | 186107 | 112  | 190106 | 76   | 190324 | 145  | 190481 | 86   | 190830 | 80   |      |      |
| 131116 | 193  | 140019 | 165  | 172252 | 92   | 186108 | 112  | 190108 | 76   | 190327 | 145  | 190482 | 86   | 190832 | 80   |      |      |
| 131117 | 193  | 140020 | 164  | 172253 | 92   | 186110 | 112  | 190110 | 76   | 190332 | 145  | 190483 | 86   | 190836 | 80   |      |      |
| 131118 | 193  | 140021 | 164  | 172254 | 92   | 186112 | 112  | 190112 | 76   | 190340 | 145  | 190484 | 86   | 190838 | 80   |      |      |
| 131120 | 193  | 140022 | 164  | 172255 | 92   | 186114 | 112  | 190114 | 76   | 190342 | 145  | 190486 | 86   | 190841 | 80   |      |      |
| 132009 | 193  | 140023 | 164  | 172256 | 92   | 186115 | 112  | 190116 | 76   | 190345 | 145  | 190487 | 86   | 190846 | 80   |      |      |
| 135001 | 192  | 140024 | 164  | 172270 | 92   | 186116 | 112  | 190118 | 76   | 190354 | 145  | 190488 | 86   | 190850 | 80   |      |      |
| 135002 | 192  | 140025 | 164  | 172271 | 92   | 186117 | 112  | 190120 | 76   | 190355 | 145  | 190489 | 86   | 190855 | 80   |      |      |
| 135003 | 192  | 140026 | 164  | 172272 | 92   | 186118 | 112  | 190122 | 76   | 190356 | 145  | 190491 | 86   | 190860 | 80   |      |      |
| 135004 | 192  | 140029 | 165  | 172273 | 92   | 186120 | 112  | 190124 | 76   | 190358 | 145  | 190492 | 86   | 190865 | 80   |      |      |
| 135005 | 192  | 140030 | 234  | 172274 | 92   | 186122 | 112  | 190126 | 76   | 190360 | 145  | 190494 | 86   | 190870 | 80   |      |      |
| 135006 | 192  | 140034 | 164  | 172275 | 92   | 186123 | 112  | 190128 | 76   | 190365 | 144  | 190501 | 238  | 190875 | 80   |      |      |
| 135007 | 192  | 140036 | 164  | 172277 | 93   | 186124 | 112  | 190130 | 76   | 190366 | 144  | 190511 | 238  | 190880 | 80   |      |      |
| 135008 | 192  | 140050 | 165  | 172280 | 93   | 186125 | 112  | 190132 | 76   | 190367 | 144  | 190532 | 243  | 190885 | 80   |      |      |
| 135009 | 192  | 140054 | 164  | 172281 | 93   | 186126 | 112  | 190140 | 77   | 190368 | 144  | 190535 | 243  | 190917 | 75   |      |      |
| 135010 | 192  | 140056 | 164  | 172282 | 93   | 186130 | 112  | 190145 | 77   | 190369 | 144  | 190540 | 239  | 190919 | 75   |      |      |
| 135011 | 192  | 140062 | 164  | 172283 | 93   | 186131 | 112  | 190157 | 75   | 190370 | 144  | 190544 | 239  | 190922 | 75   |      |      |
| 135012 | 192  | 140063 | 164  | 172286 | 93   | 186140 | 112  | 190158 | 75   | 190371 | 144  | 190552 | 241  | 190924 | 75   |      |      |
| 135013 | 192  | 140064 | 164  | 172288 | 93   | 186141 | 112  | 190159 | 75   | 190372 | 144  | 190562 | 240  | 190927 | 75   |      |      |
| 135014 | 192  | 140065 | 164  | 172295 | 94   | 186145 | 112  | 190160 | 75   | 190373 | 144  | 190564 | 240  | 190930 | 75   |      |      |
| 135015 | 192  | 140066 | 164  | 172296 | 94   | 186146 | 112  | 190161 | 75   | 190374 | 144  | 190566 | 240  | 190932 | 75   |      |      |
| 135016 | 192  | 140068 | 164  | 175001 | 89   | 186150 | 112  | 190162 | 75   | 190383 | 144  | 190568 | 241  | 190934 | 75   |      |      |
| 135017 | 192  | 140070 | 164  | 175002 | 89   | 186151 | 112  | 190163 | 75   | 190384 | 144  | 190570 | 241  | 190936 | 75   |      |      |
| 135018 | 192  | 144000 | 171  | 175003 | 89   | 186155 | 112  | 190164 | 75   | 190385 | 144  | 190572 | 237  | 190941 | 75   |      |      |
| 135019 | 192  | 144004 | 171  | 175004 | 89   | 186156 | 112  | 190166 | 75   | 190386 | 144  | 190574 | 242  | 190946 | 75   |      |      |
| 135020 | 192  | 144020 | 173  | 175005 | 89   | 186160 | 112  | 190167 | 75   | 190390 | 144  | 190575 | 242  | 190950 | 75   |      |      |
| 135021 | 192  | 144021 | 173  | 175006 | 89   | 186161 | 112  | 190168 | 75   | 190391 | 144  | 190576 | 237  | 190955 | 75   |      |      |
| 135022 | 192  | 144022 | 173  | 175007 | 89   | 186165 | 112  | 190169 | 75   | 190392 | 144  | 190577 | 242  | 190960 | 75   |      |      |
| 135051 | 192  | 144025 | 173  | 175008 | 89   | 186166 | 112  | 190171 | 75   | 190393 | 144  | 190580 | 261  | 190965 | 75   |      |      |
| 135070 | 192  | 144026 | 173  | 175009 | 89   | 186168 | 112  | 190172 | 75   | 190410 | 139  | 190581 | 261  | 190970 | 75   |      |      |
| 135080 | 192  | 144027 | 173  | 175010 | 89   | 186170 | 112  | 190174 | 75   | 190411 | 139  | 190590 | 261  | 190975 | 75   |      |      |
| 136001 | 191  | 144030 | 173  | 175011 | 89   | 186172 | 112  | 190202 | 139  | 190412 | 139  | 190591 | 261  | 190978 | 75   |      |      |
| 136002 | 191  | 144031 | 173  | 175012 | 89   | 186175 | 112  | 190204 | 139  | 190413 | 139  | 190595 | 261  | 190985 | 75   |      |      |
| 136003 | 191  | 144032 | 173  | 175013 | 89   | 186176 | 112  | 190206 | 139  | 190414 | 139  | 190596 | 261  | 191004 | 73   |      |      |
| 136004 | 191  | 144035 | 172  | 175014 | 89   | 186178 | 112  | 190208 | 139  | 190415 | 139  | 190597 | 261  | 191005 | 73   |      |      |
| 136005 | 191  | 144036 | 172  | 175015 | 89   | 186180 | 112  | 190210 | 139  | 190416 | 139  | 190601 | 24   | 191010 | 73   |      |      |
| 136006 | 191  | 144040 | 173  | 175016 | 89   | 186182 | 112  | 190212 | 139  | 190417 | 139  | 190602 | 24   | 191012 | 73   |      |      |
| 136007 | 191  | 144045 | 173  | 175017 | 89   | 186185 | 135  | 190214 | 139  | 190418 | 139  | 190603 | 24   | 191015 | 73   |      |      |

# CODE-PAGE INDEX

| Code   | Page |
|--------|------|
| 191020 | 73   |
| 191025 | 73   |
| 191028 | 73   |
| 191030 | 73   |
| 191033 | 73   |
| 191035 | 73   |
| 191038 | 73   |
| 191040 | 73   |
| 191045 | 73   |
| 191047 | 73   |
| 191050 | 73   |
| 191055 | 73   |
| 191060 | 73   |
| 191065 | 73   |
| 191070 | 73   |
| 191072 | 73   |
| 191073 | 73   |
| 191075 | 73   |
| 191076 | 73   |
| 191077 | 73   |
| 191080 | 74   |
| 191081 | 74   |
| 191082 | 74   |
| 191085 | 74   |
| 191086 | 74   |
| 191091 | 73   |
| 191096 | 74   |
| 191105 | 78   |
| 191110 | 78   |
| 191115 | 78   |
| 191120 | 78   |
| 191125 | 78   |
| 191128 | 78   |
| 191130 | 78   |
| 191133 | 78   |
| 191135 | 78   |
| 191138 | 78   |
| 191140 | 78   |
| 191145 | 78   |
| 191148 | 78   |
| 191150 | 78   |
| 191155 | 78   |
| 191160 | 78   |
| 191165 | 78   |
| 191170 | 78   |
| 191172 | 78   |
| 191175 | 78   |
| 191177 | 78   |
| 191180 | 78   |
| 191181 | 79   |
| 191182 | 78   |
| 191185 | 79   |
| 191190 | 79   |
| 191196 | 79   |
| 191203 | 76   |
| 191206 | 76   |
| 191209 | 76   |
| 191212 | 76   |
| 191215 | 76   |
| 191218 | 76   |
| 191221 | 76   |
| 191224 | 76   |
| 191227 | 76   |
| 191230 | 76   |
| 191233 | 76   |
| 191236 | 76   |
| 191239 | 76   |
| 191242 | 76   |
| 191245 | 76   |
| 191248 | 76   |
| 191251 | 76   |
| 191254 | 76   |
| 191257 | 76   |
| 191260 | 76   |
| 191263 | 76   |
| 191266 | 76   |

| Code   | Page |
|--------|------|
| 191269 | 76   |
| 191272 | 76   |
| 191275 | 76   |
| 191278 | 76   |
| 191279 | 76   |
| 191280 | 77   |
| 191281 | 76   |
| 191282 | 76   |
| 191283 | 76   |
| 191284 | 76   |
| 191285 | 77   |
| 191286 | 77   |
| 191291 | 76   |
| 191296 | 77   |
| 191305 | 81   |
| 191310 | 81   |
| 191315 | 81   |
| 191320 | 81   |
| 191325 | 81   |
| 191330 | 81   |
| 191335 | 81   |
| 191340 | 81   |
| 191345 | 81   |
| 191350 | 81   |
| 191355 | 81   |
| 191357 | 81   |
| 191360 | 81   |
| 191370 | 80   |
| 191371 | 80   |
| 191372 | 80   |
| 191373 | 80   |
| 191374 | 80   |
| 191375 | 80   |
| 191376 | 80   |
| 191377 | 80   |
| 191378 | 80   |
| 191379 | 80   |
| 191381 | 80   |
| 191382 | 80   |
| 191383 | 80   |
| 191384 | 80   |
| 191385 | 80   |
| 191386 | 80   |
| 191387 | 80   |
| 191388 | 80   |
| 191389 | 80   |
| 191396 | 81   |
| 191397 | 81   |
| 191398 | 81   |
| 191405 | 87   |
| 191410 | 87   |
| 191415 | 87   |
| 191420 | 87   |
| 191425 | 87   |
| 191430 | 87   |
| 191435 | 87   |
| 191440 | 87   |
| 191445 | 87   |
| 191450 | 87   |
| 191452 | 87   |
| 191455 | 87   |
| 191457 | 87   |
| 191460 | 87   |
| 191470 | 87   |
| 191475 | 87   |
| 191480 | 87   |
| 191485 | 87   |
| 191492 | 90   |
| 191494 | 90   |
| 191496 | 90   |
| 191498 | 90   |
| 191499 | 90   |
| 191505 | 88   |
| 191510 | 88   |
| 191515 | 88   |
| 191520 | 88   |

| Code   | Page |
|--------|------|
| 191525 | 88   |
| 191530 | 88   |
| 191535 | 88   |
| 191540 | 88   |
| 191545 | 88   |
| 191550 | 88   |
| 191552 | 88   |
| 191555 | 88   |
| 191557 | 88   |
| 191560 | 88   |
| 191565 | 88   |
| 191570 | 88   |
| 191575 | 88   |
| 191600 | 82   |
| 191605 | 82   |
| 191610 | 82   |
| 191615 | 82   |
| 191620 | 82   |
| 191625 | 82   |
| 191630 | 85   |
| 191632 | 85   |
| 191634 | 85   |
| 191636 | 85   |
| 191640 | 85   |
| 191650 | 82   |
| 191652 | 91   |
| 191654 | 91   |
| 191656 | 91   |
| 191658 | 91   |
| 191660 | 91   |
| 191662 | 91   |
| 191664 | 91   |
| 191666 | 91   |
| 191668 | 91   |
| 191670 | 91   |
| 191672 | 91   |
| 191675 | 91   |
| 191682 | 91   |
| 191684 | 91   |
| 191686 | 91   |
| 191688 | 91   |
| 191690 | 91   |
| 191692 | 91   |
| 191695 | 90   |
| 191697 | 90   |
| 191710 | 88   |
| 191720 | 88   |
| 191730 | 88   |
| 191740 | 88   |
| 191750 | 88   |
| 191760 | 88   |
| 191805 | 83   |
| 191810 | 83   |
| 191815 | 83   |
| 191820 | 83   |
| 191825 | 83   |
| 191830 | 83   |
| 191835 | 83   |
| 191840 | 83   |
| 191845 | 83   |
| 191850 | 83   |
| 191855 | 83   |
| 191860 | 83   |
| 191862 | 83   |
| 191864 | 83   |
| 191866 | 83   |
| 191868 | 83   |
| 191870 | 83   |
| 191872 | 83   |
| 191876 | 83   |
| 191880 | 82   |
| 191881 | 82   |
| 191882 | 82   |
| 191885 | 82   |
| 191886 | 82   |
| 191890 | 83   |

| Code   | Page |
|--------|------|
| 191900 | 213  |
| 191905 | 84   |
| 191910 | 84   |
| 191915 | 84   |
| 191920 | 84   |
| 191925 | 84   |
| 191930 | 84   |
| 191935 | 84   |
| 191950 | 84   |
| 191951 | 84   |
| 191955 | 85   |
| 191960 | 85   |
| 191965 | 85   |
| 191970 | 85   |
| 191975 | 85   |
| 191980 | 85   |
| 191990 | 86   |
| 191995 | 86   |
| 192003 | 132  |
| 192004 | 132  |
| 192005 | 132  |
| 192006 | 132  |
| 192008 | 132  |
| 192014 | 132  |
| 192015 | 132  |
| 192016 | 132  |
| 192018 | 132  |
| 192021 | 132  |
| 192022 | 132  |
| 192023 | 132  |
| 192031 | 132  |
| 192032 | 132  |
| 192033 | 132  |
| 192040 | 132  |
| 192041 | 132  |
| 192042 | 132  |
| 192043 | 132  |
| 192044 | 132  |
| 192045 | 132  |
| 192046 | 132  |
| 192047 | 132  |
| 192048 | 132  |
| 192049 | 132  |
| 192050 | 132  |
| 192051 | 132  |
| 192052 | 132  |
| 192053 | 132  |
| 192054 | 132  |
| 192055 | 132  |
| 192056 | 132  |
| 192057 | 132  |
| 192058 | 132  |
| 192059 | 132  |
| 192060 | 132  |
| 192064 | 132  |
| 192065 | 132  |
| 192066 | 132  |
| 192068 | 132  |
| 192100 | 132  |
| 192101 | 131  |
| 192102 | 131  |
| 192103 | 131  |
| 192104 | 131  |
| 192105 | 131  |
| 192106 | 131  |
| 192107 | 131  |
| 192108 | 131  |
| 192109 | 131  |
| 192110 | 131  |
| 192111 | 131  |
| 192112 | 131  |
| 192113 | 131  |
| 192114 | 131  |
| 192115 | 131  |
| 192116 | 131  |
| 192117 | 131  |

| Code   | Page |
|--------|------|
| 192118 | 131  |
| 192119 | 131  |
| 192120 | 131  |
| 192121 | 131  |
| 192122 | 131  |
| 192124 | 131  |
| 192126 | 131  |
| 192127 | 131  |
| 192133 | 130  |
| 192136 | 130  |
| 192138 | 130  |
| 192139 | 130  |
| 192145 | 133  |
| 192150 | 133  |
| 192155 | 133  |
| 192160 | 133  |
| 192161 | 133  |
| 192162 | 133  |
| 192163 | 133  |
| 192164 | 133  |
| 192165 | 133  |
| 192170 | 133  |
| 192182 | 130  |
| 192187 | 129  |
| 192195 | 129  |
| 192197 | 14   |
| 192208 | 135  |
| 192209 | 135  |
| 192210 | 135  |
| 192211 | 135  |
| 192212 | 135  |
| 192213 | 135  |
| 192214 | 135  |
| 192215 | 135  |
| 192216 | 135  |
| 192217 | 135  |
| 192218 | 135  |
| 192219 | 135  |
| 192221 | 135  |
| 192222 | 135  |
| 192225 | 135  |
| 192228 | 135  |
| 192230 | 135  |
| 192232 | 135  |
| 192233 | 135  |
| 192237 | 135  |
| 192239 | 135  |
| 192243 | 134  |
| 192244 | 134  |
| 192246 | 134  |
| 192250 | 135  |
| 192255 | 135  |
| 192260 | 135  |
| 192265 | 135  |
| 192270 | 135  |
| 192275 | 135  |
| 192276 | 135  |
| 192287 | 134  |
| 192290 | 14   |
| 192294 | 140  |
| 192295 | 140  |
| 192296 | 140  |
| 192297 | 140  |
| 192298 | 140  |
| 192299 | 140  |
| 192300 | 140  |
| 192305 | 140  |
| 192308 | 139  |
| 192310 | 139  |
| 192311 | 139  |
| 192312 | 139  |
| 192313 | 139  |
| 192314 | 139  |
| 192315 | 139  |
| 192316 | 139  |
| 192317 | 139  |

| Code   | Page |
|--------|------|
| 192318 | 139  |
| 192319 | 139  |
| 192320 | 139  |
| 192321 | 139  |
| 192322 | 139  |
| 192323 | 139  |
| 192324 | 139  |
| 192325 | 139  |
| 192326 | 139  |
| 192327 | 139  |
| 192328 | 139  |
| 192329 | 139  |
| 192330 | 139  |
| 192332 | 139  |
| 192333 | 140  |
| 192334 | 140  |
| 192343 | 138  |
| 192344 | 138  |
| 192347 | 138  |
| 192348 | 138  |
| 192352 | 141  |
| 192355 | 141  |
| 192356 | 141  |
| 192358 | 141  |
| 192359 | 141  |
| 192360 | 141  |
| 192362 | 141  |
| 192363 | 141  |
| 192365 | 141  |
| 192383 | 137  |
| 192384 | 137  |
| 192386 | 136  |
| 192387 | 14   |
| 192389 | 136  |
| 192405 | 142  |
| 192406 | 142  |
| 192407 | 142  |
| 192408 | 142  |
| 192409 | 142  |
| 192410 | 142  |
| 192412 | 142  |
| 192414 | 142  |
| 192417 | 142  |
| 192420 | 142  |
| 192425 | 142  |
| 192427 | 142  |
| 192430 | 142  |
| 192440 | 142  |
| 192445 | 142  |
| 192450 | 142  |
| 192455 | 142  |
| 192460 | 142  |
| 192470 | 142  |
| 192475 | 143  |
| 192476 | 143  |
| 192477 | 143  |
| 192478 | 143  |
| 192480 | 142  |
| 192481 | 143  |
| 192482 | 143  |
| 192483 | 143  |
| 192484 | 143  |
| 192485 | 143  |
| 192486 | 143  |
| 192490 | 14   |
| 192501 | 139  |
| 192502 | 139  |
| 192503 | 139  |
| 192504 | 139  |
| 192505 | 139  |
| 192506 | 139  |
| 192507 | 139  |
| 192508 | 139  |
| 192509 | 139  |
| 192510 | 139  |
| 192511 | 139  |

| Code   | Page |
|--------|------|
| 192512 | 139  |
| 192513 | 139  |
| 192514 | 139  |
| 192515 | 139  |
| 192516 | 139  |
| 192517 | 139  |
| 192518 | 140  |
| 192519 | 147  |
| 192521 | 147  |
| 192522 | 147  |
| 192524 | 147  |
| 192527 | 147  |
| 192530 | 147  |
| 192532 | 147  |
| 192533 | 147  |
| 192534 | 147  |
| 192536 | 147  |
| 192538 | 147  |
| 192541 | 147  |
| 192546 | 147  |
| 192550 | 147  |
| 192555 | 147  |
| 192560 | 147  |
| 192565 | 147  |
| 192570 | 147  |
| 192575 | 147  |
| 192580 | 146  |
| 192604 | 24   |
| 192605 | 133  |
| 192610 | 135  |
| 192615 | 135  |
| 192620 | 141  |
| 192625 | 141  |
| 192630 | 147  |
| 192632 | 147  |
| 192640 | 31   |
| 192641 | 31   |
| 192645 | 31   |
| 192646 | 31   |
| 192648 | 146  |
| 192649 | 146  |
| 192650 | 146  |
| 192652 | 146  |
| 192675 | 30   |
| 192676 | 30   |
| 192677 | 30   |
| 192678 | 22   |
| 192679 |      |

# CODE-PAGE INDEX

| Code   | Page | Code   | Page | Code   | Page | Code   | Page | Code   | Page | Code   | Page | Code   | Page | Code   | Page |
|--------|------|--------|------|--------|------|--------|------|--------|------|--------|------|--------|------|--------|------|
| 193144 | 99   | 193594 | 110  | 193993 | 111  | 194860 | 148  | 195710 | 207  | 196282 | 227  | 196590 | 159  | 196875 | 216  |
| 193145 | 99   | 193595 | 110  | 193994 | 111  | 194865 | 148  | 195711 | 207  | 196288 | 228  | 196595 | 161  | 196880 | 45   |
| 193148 | 100  | 193596 | 110  | 193995 | 111  | 194870 | 148  | 195715 | 207  | 196290 | 226  | 196603 | 158  | 196882 | 45   |
| 193171 | 99   | 193597 | 110  | 193996 | 111  | 194875 | 148  | 195716 | 207  | 196292 | 226  | 196604 | 158  | 196885 | 217  |
| 193172 | 99   | 193598 | 110  | 194006 | 103  | 194880 | 148  | 195717 | 207  | 196294 | 226  | 196605 | 158  | 196886 | 217  |
| 193173 | 99   | 193599 | 110  | 194007 | 103  | 194885 | 148  | 195718 | 207  | 196302 | 228  | 196606 | 158  | 196890 | 216  |
| 193174 | 99   | 193601 | 111  | 194008 | 103  | 194886 | 148  | 195720 | 207  | 196305 | 211  | 196608 | 158  | 196894 | 217  |
| 193175 | 99   | 193603 | 110  | 194009 | 103  | 194887 | 148  | 195721 | 207  | 196306 | 211  | 196612 | 157  | 196895 | 217  |
| 193176 | 99   | 193606 | 111  | 194010 | 103  | 194888 | 148  | 195723 | 207  | 196310 | 211  | 196613 | 157  | 196896 | 217  |
| 193178 | 99   | 193611 | 111  | 194015 | 103  | 194890 | 148  | 195724 | 207  | 196311 | 211  | 196617 | 157  | 196897 | 217  |
| 193181 | 99   | 193616 | 111  | 194020 | 103  | 195205 | 106  | 195725 | 207  | 196315 | 211  | 196618 | 158  | 196898 | 217  |
| 193182 | 99   | 193621 | 111  | 194025 | 103  | 195206 | 106  | 195726 | 207  | 196316 | 211  | 196619 | 158  | 196899 | 217  |
| 193206 | 103  | 193636 | 110  | 194027 | 103  | 195207 | 106  | 195730 | 208  | 196318 | 211  | 196622 | 157  | 196905 | 167  |
| 193207 | 103  | 193637 | 110  | 194030 | 103  | 195208 | 106  | 195731 | 208  | 196320 | 211  | 196625 | 159  | 196910 | 167  |
| 193208 | 103  | 193638 | 110  | 194040 | 103  | 195209 | 106  | 195740 | 208  | 196321 | 211  | 196627 | 159  | 196911 | 166  |
| 193209 | 103  | 193646 | 110  | 194045 | 103  | 195210 | 106  | 195741 | 208  | 196322 | 211  | 196628 | 157  | 196915 | 167  |
| 193210 | 103  | 193647 | 110  | 194050 | 103  | 195211 | 106  | 195750 | 208  | 196325 | 212  | 196629 | 157  | 196916 | 166  |
| 193215 | 103  | 193648 | 110  | 194055 | 103  | 195212 | 106  | 195751 | 208  | 196340 | 212  | 196630 | 159  | 196920 | 167  |
| 193220 | 103  | 193656 | 110  | 194060 | 103  | 195213 | 106  | 195760 | 208  | 196350 | 212  | 196631 | 159  | 196921 | 166  |
| 193225 | 103  | 193657 | 110  | 194100 | 97   | 195214 | 106  | 195761 | 208  | 196360 | 212  | 196632 | 157  | 196925 | 167  |
| 193227 | 103  | 193658 | 110  | 194105 | 97   | 195227 | 106  | 195762 | 210  | 196375 | 212  | 196633 | 160  | 196926 | 166  |
| 193230 | 103  | 193666 | 110  | 194110 | 97   | 195228 | 106  | 195764 | 210  | 196385 | 212  | 196634 | 157  | 196930 | 167  |
| 193240 | 103  | 193667 | 110  | 194115 | 97   | 195230 | 106  | 195768 | 209  | 196390 | 212  | 196652 | 157  | 196935 | 167  |
| 193245 | 103  | 193668 | 110  | 194120 | 97   | 195232 | 106  | 195770 | 209  | 196395 | 212  | 196653 | 157  | 196940 | 167  |
| 193250 | 103  | 193725 | 114  | 194121 | 97   | 195233 | 106  | 195772 | 209  | 196399 | 212  | 196654 | 157  | 196942 | 213  |
| 193255 | 103  | 193730 | 113  | 194122 | 97   | 195240 | 106  | 195774 | 209  | 196401 | 212  | 196657 | 157  | 196945 | 213  |
| 193260 | 103  | 193740 | 113  | 194123 | 97   | 195245 | 106  | 195775 | 210  | 196403 | 212  | 196658 | 157  | 196950 | 167  |
| 193270 | 103  | 193742 | 113  | 194124 | 97   | 195250 | 106  | 195776 | 210  | 196406 | 212  | 196663 | 157  | 196952 | 166  |
| 193281 | 104  | 193744 | 113  | 194127 | 97   | 195255 | 106  | 195780 | 209  | 196411 | 212  | 196664 | 157  | 196955 | 167  |
| 193283 | 104  | 193750 | 113  | 194129 | 97   | 195261 | 105  | 195785 | 209  | 196416 | 212  | 196665 | 159  | 196956 | 166  |
| 193290 | 103  | 193751 | 113  | 194133 | 97   | 195262 | 105  | 195786 | 209  | 196421 | 212  | 196666 | 161  | 196957 | 166  |
| 193292 | 104  | 193752 | 113  | 194137 | 97   | 195263 | 105  | 195787 | 209  | 196422 | 212  | 196667 | 159  | 196960 | 167  |
| 193369 | 127  | 193753 | 113  | 194139 | 97   | 195264 | 105  | 195788 | 211  | 196423 | 212  | 196675 | 159  | 196961 | 166  |
| 193455 | 121  | 193902 | 101  | 194142 | 97   | 195265 | 105  | 195790 | 210  | 196430 | 212  | 196676 | 159  | 196962 | 166  |
| 193465 | 122  | 193903 | 101  | 194144 | 97   | 195266 | 105  | 195792 | 210  | 196440 | 212  | 196680 | 159  | 196965 | 167  |
| 193467 | 123  | 193904 | 101  | 194145 | 97   | 195268 | 105  | 195795 | 211  | 196450 | 212  | 196681 | 159  | 196966 | 166  |
| 193470 | 107  | 193905 | 101  | 194146 | 97   | 195270 | 105  | 195796 | 211  | 196460 | 212  | 196690 | 159  | 196970 | 167  |
| 193503 | 110  | 193906 | 101  | 194147 | 97   | 195271 | 105  | 195800 | 210  | 196480 | 212  | 196695 | 161  | 196971 | 166  |
| 193506 | 110  | 193907 | 101  | 194148 | 97   | 195274 | 105  | 195804 | 208  | 196490 | 212  | 196701 | 162  | 196975 | 166  |
| 193511 | 110  | 193908 | 101  | 194149 | 97   | 195282 | 107  | 195806 | 208  | 196495 | 212  | 196702 | 162  | 196977 | 166  |
| 193516 | 110  | 193910 | 101  | 194150 | 97   | 195284 | 107  | 195900 | 206  | 196496 | 212  | 196703 | 162  | 196979 | 167  |
| 193521 | 110  | 193912 | 101  | 194151 | 97   | 195309 | 105  | 195901 | 206  | 196499 | 212  | 196704 | 162  | 196989 | 169  |
| 193536 | 109  | 193914 | 101  | 194152 | 97   | 195310 | 105  | 195905 | 206  | 196500 | 158  | 196705 | 162  | 196994 | 169  |
| 193537 | 109  | 193925 | 101  | 194153 | 97   | 195315 | 105  | 195906 | 206  | 196501 | 158  | 196710 | 162  | 196995 | 169  |
| 193538 | 109  | 193935 | 111  | 194154 | 97   | 195320 | 105  | 195910 | 206  | 196502 | 158  | 196715 | 162  | 197001 | 169  |
| 193546 | 109  | 193936 | 111  | 194157 | 97   | 195325 | 105  | 195911 | 206  | 196503 | 158  | 196720 | 162  | 197003 | 169  |
| 193547 | 109  | 193938 | 111  | 194159 | 97   | 195327 | 105  | 195915 | 206  | 196504 | 158  | 196725 | 162  | 197004 | 169  |
| 193548 | 109  | 193940 | 111  | 194163 | 97   | 195330 | 105  | 195916 | 206  | 196510 | 157  | 196727 | 162  | 197014 | 186  |
| 193556 | 109  | 193942 | 111  | 194167 | 97   | 195340 | 105  | 195920 | 206  | 196511 | 157  | 196730 | 162  | 197016 | 186  |
| 193557 | 109  | 193944 | 111  | 194169 | 97   | 195350 | 105  | 195921 | 206  | 196515 | 157  | 196732 | 162  | 197017 | 186  |
| 193558 | 109  | 193945 | 111  | 194172 | 97   | 195580 | 176  | 195925 | 206  | 196518 | 158  | 196760 | 162  | 197019 | 186  |
| 193566 | 109  | 193946 | 111  | 194174 | 97   | 195582 | 176  | 195926 | 206  | 196519 | 158  | 196762 | 162  | 197020 | 186  |
| 193567 | 109  | 193948 | 111  | 194175 | 97   | 195606 | 174  | 195930 | 206  | 196520 | 157  | 196764 | 162  | 197021 | 186  |
| 193568 | 109  | 193950 | 111  | 194176 | 97   | 195607 | 174  | 195931 | 206  | 196522 | 157  | 196766 | 162  | 197022 | 186  |
| 193570 | 109  | 193952 | 111  | 194177 | 97   | 195608 | 174  | 196005 | 227  | 196523 | 157  | 196768 | 162  | 197024 | 186  |
| 193571 | 109  | 193954 | 111  | 194178 | 97   | 195609 | 175  | 196010 | 227  | 196524 | 157  | 196780 | 163  | 197025 | 186  |
| 193572 | 109  | 193961 | 111  | 194179 | 97   | 195610 | 176  | 196015 | 227  | 196525 | 159  | 196781 | 163  | 197027 | 186  |
| 193573 | 109  | 193962 | 111  | 194180 | 97   | 195611 | 176  | 196020 | 227  | 196527 | 157  | 196782 | 163  | 197029 | 186  |
| 193574 | 109  | 193963 | 111  | 194182 | 97   | 195618 | 175  | 196025 | 227  | 196530 | 159  | 196783 | 163  | 197030 | 186  |
| 193575 | 109  | 193964 | 111  | 194184 | 97   | 195620 | 175  | 196180 | 227  | 196531 | 159  | 196784 | 163  | 197032 | 186  |
| 193576 | 109  | 193965 | 111  | 194805 | 112  | 195622 | 176  | 196182 | 227  | 196548 | 157  | 196785 | 163  | 197033 | 186  |
| 193578 | 109  | 193967 | 111  | 194806 | 112  | 195635 | 175  | 196184 | 227  | 196550 | 157  | 196786 | 163  | 197035 | 186  |
| 193580 | 109  | 193968 | 111  | 194807 | 112  | 195640 | 175  | 196190 | 231  | 196551 | 157  | 196787 | 163  | 197037 | 186  |
| 193581 | 110  | 193970 | 101  | 194808 | 112  | 195660 | 176  | 196195 | 231  | 196554 | 157  | 196788 | 163  | 197038 | 186  |
| 193582 | 110  | 193971 | 111  | 194809 | 112  | 195665 | 176  | 196197 | 231  | 196555 | 157  | 196789 | 163  | 197040 | 186  |
| 193583 | 110  | 193972 | 111  | 194810 | 112  | 195675 | 176  | 196199 | 231  | 196556 | 157  | 196790 | 163  | 197041 | 186  |
| 193584 | 110  | 193973 | 111  | 194811 | 112  | 195680 | 176  | 196200 | 231  | 196560 | 157  | 196792 | 163  | 197043 | 186  |
| 193585 | 110  | 193980 | 111  | 194812 | 112  | 195685 | 176  | 196203 | 228  | 196562 | 157  | 196805 | 162  | 197044 | 186  |
| 193586 | 110  | 193981 | 111  | 194813 | 112  | 195690 | 176  | 196204 | 226  | 196563 | 157  | 196810 | 162  | 197046 | 186  |
| 193587 | 110  | 193982 | 111  | 194815 | 112  | 195695 | 176  | 196206 | 226  | 196565 | 159  | 196815 | 162  | 197048 | 186  |
| 193588 | 110  | 193983 | 111  | 194820 | 148  | 195700 | 207  | 196208 | 226  | 196566 | 161  | 196818 | 45   | 197051 | 186  |
| 193589 | 110  | 193984 | 111  | 194836 | 148  | 195701 | 207  | 196210 | 226  | 196570 | 159  | 196850 | 44   | 197052 | 186  |
| 193590 | 110  | 193985 | 111  | 194841 | 148  | 195705 | 207  | 196212 | 226  | 196575 | 159  | 196852 | 45   | 197054 | 186  |
| 193591 | 110  | 193990 | 111  | 194846 | 148  | 195706 | 207  | 196225 | 227  | 196576 | 159  | 196860 | 44   | 197056 | 186  |
| 193592 | 110  | 193991 | 111  | 194850 | 148  | 195708 | 207  | 196255 | 228  | 196580 | 159  | 196870 | 216  | 197057 | 186  |
| 193593 | 110  | 193992 | 111  | 194855 | 148  | 195709 | 207  | 196280 | 227  | 196581 | 159  | 196872 | 44   | 197059 | 186  |

# CODE-PAGE INDEX

| Code   | Page |
|--------|------|
| 197060 | 186  |
| 197064 | 186  |
| 197065 | 186  |
| 197067 | 186  |
| 197068 | 186  |
| 197070 | 186  |
| 197073 | 186  |
| 197076 | 186  |
| 197079 | 186  |
| 197083 | 186  |
| 197086 | 186  |
| 197089 | 186  |
| 197092 | 186  |
| 197095 | 186  |
| 197098 | 186  |
| 197102 | 186  |
| 197105 | 186  |
| 197108 | 186  |
| 197111 | 186  |
| 197114 | 186  |
| 197121 | 186  |
| 197127 | 186  |
| 197140 | 186  |
| 197152 | 186  |
| 197160 | 187  |
| 197170 | 187  |
| 197200 | 186  |
| 197210 | 186  |
| 197212 | 187  |
| 197215 | 187  |
| 197220 | 187  |
| 197230 | 187  |
| 197240 | 187  |
| 197250 | 187  |
| 197260 | 171  |
| 197280 | 232  |
| 197281 | 232  |
| 197282 | 232  |
| 197300 | 229  |
| 197303 | 229  |
| 197305 | 229  |
| 197307 | 229  |
| 197310 | 229  |
| 197312 | 229  |
| 197315 | 229  |
| 197316 | 229  |
| 197320 | 229  |
| 197322 | 229  |
| 197324 | 229  |
| 197325 | 230  |
| 197330 | 230  |
| 197340 | 230  |
| 197350 | 230  |
| 197355 | 231  |
| 197357 | 230  |
| 197360 | 230  |
| 197362 | 234  |
| 197365 | 234  |
| 197370 | 233  |
| 197372 | 233  |
| 197374 | 233  |
| 197375 | 232  |
| 197380 | 232  |
| 197385 | 232  |
| 197386 | 232  |
| 197390 | 232  |
| 197392 | 232  |
| 197394 | 232  |
| 197396 | 232  |
| 197398 | 232  |
| 197399 | 232  |
| 197415 | 233  |
| 197420 | 233  |
| 197450 | 168  |
| 197455 | 168  |
| 197456 | 168  |

| Code   | Page |
|--------|------|
| 197460 | 168  |
| 197461 | 168  |
| 197465 | 168  |
| 197466 | 168  |
| 197470 | 168  |
| 197471 | 168  |
| 197472 | 168  |
| 197473 | 168  |
| 197474 | 168  |
| 197475 | 168  |
| 197480 | 169  |
| 197481 | 169  |
| 197495 | 180  |
| 197497 | 181  |
| 197499 | 178  |
| 197500 | 178  |
| 197502 | 178  |
| 197504 | 178  |
| 197505 | 178  |
| 197506 | 178  |
| 197509 | 178  |
| 197510 | 178  |
| 197512 | 178  |
| 197514 | 178  |
| 197515 | 178  |
| 197516 | 178  |
| 197518 | 179  |
| 197519 | 179  |
| 197520 | 179  |
| 197521 | 179  |
| 197524 | 179  |
| 197525 | 179  |
| 197526 | 179  |
| 197528 | 179  |
| 197529 | 179  |
| 197530 | 179  |
| 197531 | 179  |
| 197534 | 181  |
| 197535 | 181  |
| 197536 | 181  |
| 197539 | 181  |
| 197540 | 181  |
| 197541 | 181  |
| 197544 | 181  |
| 197545 | 181  |
| 197546 | 181  |
| 197549 | 181  |
| 197550 | 180  |
| 197552 | 180  |
| 197554 | 180  |
| 197555 | 185  |
| 197556 | 185  |
| 197558 | 185  |
| 197560 | 185  |
| 197561 | 185  |
| 197562 | 185  |
| 197565 | 185  |
| 197601 | 179  |
| 197602 | 182  |
| 197603 | 179  |
| 197604 | 182  |
| 197605 | 179  |
| 197606 | 182  |
| 197610 | 182  |
| 197612 | 182  |
| 197614 | 182  |
| 197620 | 183  |
| 197622 | 183  |
| 197624 | 183  |
| 197630 | 184  |
| 197632 | 184  |
| 197635 | 184  |
| 197640 | 184  |
| 197642 | 184  |
| 197645 | 184  |
| 197650 | 182  |

| Code   | Page |
|--------|------|
| 197651 | 183  |
| 197652 | 182  |
| 197655 | 184  |
| 197656 | 183  |
| 197658 | 184  |
| 197660 | 184  |
| 197662 | 184  |
| 197702 | 178  |
| 197704 | 178  |
| 197705 | 178  |
| 197710 | 178  |
| 197712 | 178  |
| 197714 | 178  |
| 197720 | 179  |
| 197721 | 179  |
| 197725 | 179  |
| 197730 | 179  |
| 197800 | 214  |
| 197805 | 214  |
| 197810 | 214  |
| 197850 | 214  |
| 197855 | 214  |
| 197860 | 214  |
| 197865 | 214  |
| 197870 | 214  |
| 197872 | 214  |
| 197873 | 214  |
| 197875 | 214  |
| 197877 | 214  |
| 197880 | 214  |
| 197882 | 214  |
| 197900 | 214  |
| 197905 | 214  |
| 197910 | 214  |
| 197915 | 214  |
| 197920 | 214  |
| 197932 | 205  |
| 197934 | 205  |
| 197936 | 205  |
| 197938 | 205  |
| 197942 | 205  |
| 197944 | 205  |
| 197946 | 205  |
| 197950 | 214  |
| 197955 | 214  |
| 197960 | 214  |
| 197965 | 214  |
| 197970 | 215  |
| 197972 | 215  |
| 197975 | 215  |
| 197976 | 215  |
| 197982 | 215  |
| 197985 | 215  |
| 197986 | 215  |
| 197987 | 215  |
| 197988 | 215  |
| 197990 | 251  |
| 197992 | 251  |
| 197995 | 251  |
| 198005 | 251  |
| 198010 | 251  |
| 198050 | 215  |
| 198052 | 215  |
| 198054 | 215  |
| 198070 | 215  |
| 198072 | 215  |
| 198074 | 215  |
| 198100 | 41   |
| 198101 | 19   |
| 198105 | 41   |
| 198106 | 19   |
| 198110 | 41   |
| 198111 | 19   |
| 198115 | 41   |
| 198116 | 19   |
| 198150 | 42   |

| Code   | Page |
|--------|------|
| 198152 | 43   |
| 198154 | 43   |
| 198160 | 42   |
| 198180 | 152  |
| 198181 | 152  |
| 198182 | 152  |
| 198183 | 152  |
| 198184 | 152  |
| 198185 | 152  |
| 198200 | 150  |
| 198201 | 150  |
| 198202 | 150  |
| 198203 | 150  |
| 198204 | 150  |
| 198205 | 150  |
| 198206 | 150  |
| 198208 | 149  |
| 198209 | 149  |
| 198210 | 149  |
| 198211 | 149  |
| 198212 | 149  |
| 198213 | 149  |
| 198214 | 149  |
| 198215 | 149  |
| 198216 | 149  |
| 198217 | 149  |
| 198218 | 149  |
| 198219 | 149  |
| 198220 | 149  |
| 198221 | 149  |
| 198222 | 149  |
| 198223 | 149  |
| 198224 | 149  |
| 198227 | 149  |
| 198230 | 149  |
| 198232 | 149  |
| 198233 | 149  |
| 198240 | 150  |
| 198241 | 150  |
| 198242 | 150  |
| 198243 | 150  |
| 198244 | 150  |
| 198245 | 150  |
| 198246 | 150  |
| 198247 | 150  |
| 198248 | 150  |
| 198249 | 150  |
| 198250 | 150  |
| 198251 | 150  |
| 198252 | 150  |
| 198253 | 150  |
| 198254 | 150  |
| 198255 | 150  |
| 198256 | 150  |
| 198258 | 150  |
| 198260 | 151  |
| 198262 | 151  |
| 198265 | 151  |
| 198270 | 151  |
| 198275 | 151  |
| 198276 | 155  |
| 198277 | 155  |
| 198278 | 155  |
| 198279 | 155  |
| 198285 | 152  |
| 198286 | 152  |
| 198288 | 152  |
| 198290 | 152  |
| 198292 | 152  |
| 198294 | 152  |
| 198297 | 152  |
| 198299 | 152  |
| 198300 | 152  |
| 198301 | 152  |
| 198302 | 152  |
| 198304 | 152  |

| Code   | Page |
|--------|------|
| 198306 | 152  |
| 198308 | 152  |
| 198310 | 152  |
| 198312 | 152  |
| 198314 | 152  |
| 198316 | 152  |
| 198317 | 153  |
| 198319 | 153  |
| 198321 | 153  |
| 198322 | 153  |
| 198324 | 153  |
| 198327 | 153  |
| 198330 | 153  |
| 198332 | 153  |
| 198334 | 153  |
| 198336 | 153  |
| 198338 | 153  |
| 198341 | 153  |
| 198346 | 153  |
| 198350 | 153  |
| 198355 | 153  |
| 198360 | 153  |
| 198370 | 153  |
| 198371 | 153  |
| 198372 | 153  |
| 198373 | 153  |
| 198374 | 153  |
| 198375 | 153  |
| 198376 | 153  |
| 198377 | 153  |
| 198378 | 153  |
| 198379 | 153  |
| 198380 | 153  |
| 198382 | 153  |
| 198384 | 153  |
| 198386 | 153  |
| 198390 | 153  |
| 198392 | 153  |
| 198395 | 153  |
| 198396 | 155  |
| 198397 | 155  |
| 198398 | 155  |
| 198399 | 155  |
| 198424 | 154  |
| 198427 | 154  |
| 198430 | 154  |
| 198432 | 154  |
| 198434 | 154  |
| 198436 | 154  |
| 198438 | 154  |
| 198441 | 154  |
| 198446 | 154  |
| 198450 | 154  |
| 198455 | 154  |
| 198460 | 154  |
| 198465 | 154  |
| 198470 | 154  |
| 198475 | 154  |
| 198476 | 154  |
| 198477 | 154  |
| 198478 | 154  |
| 198479 | 154  |
| 198480 | 154  |
| 198481 | 154  |
| 198482 | 154  |
| 198483 | 154  |
| 198490 | 154  |
| 198492 | 154  |
| 198495 | 154  |
| 198497 | 154  |
| 198498 | 155  |
| 198499 | 155  |
| 198500 | 203  |
| 198501 | 203  |
| 198502 | 203  |
| 198503 | 203  |

| Code   | Page |
|--------|------|
| 198505 | 203  |
| 198506 | 203  |
| 198507 | 203  |
| 198510 | 204  |
| 198512 | 204  |
| 198514 | 204  |
| 198516 | 204  |
| 198518 | 199  |
| 198519 | 199  |
| 198520 | 199  |
| 198521 | 199  |
| 198524 | 204  |
| 198525 | 204  |
| 198526 | 204  |
| 198527 | 204  |
| 198529 | 204  |
| 198534 | 204  |
| 198535 | 204  |
| 198538 | 204  |
| 198539 | 204  |
| 198544 | 204  |
| 198548 | 204  |
| 198550 | 204  |
| 198558 | 204  |
| 198600 | 201  |
| 198601 | 203  |
| 198602 | 203  |
| 198603 | 201  |
| 198605 | 201  |
| 198610 | 201  |
| 198611 | 203  |
| 198612 | 203  |
| 198613 | 201  |
| 198614 | 202  |
| 198615 | 201  |
| 198617 | 202  |
| 198619 | 202  |
| 198620 | 160  |
| 198621 | 202  |
| 198622 | 202  |
| 198625 | 160  |
| 198626 | 160  |
| 198630 | 160  |
| 198632 | 160  |
| 198633 | 160  |
| 198650 | 161  |
| 198655 | 161  |
| 198658 | 161  |
| 198660 | 161  |
| 198670 | 160  |
| 198675 | 160  |
| 198676 | 160  |
| 198720 | 160  |
| 198725 | 160  |
| 198726 | 160  |
| 198730 | 160  |
| 198732 | 160  |
| 198733 | 160  |
| 198748 | 160  |
| 198750 | 161  |
| 198755 | 161  |
| 198758 | 161  |
| 198760 | 161  |
| 198776 | 160  |
| 198805 | 262  |
| 198807 | 262  |
| 198810 | 263  |
| 198815 | 263  |
| 198816 | 263  |
| 198818 | 262  |
| 198820 | 263  |
| 198821 | 263  |
| 198826 | 265  |
| 198828 | 265  |
| 198830 | 265  |
| 198832 | 265  |

| Code   | Page |
|--------|------|
| 198835 | 265  |
| 198850 | 260  |
| 198851 | 260  |
| 198852 | 260  |
| 198855 | 260  |
| 198856 | 260  |
| 198857 | 260  |
| 198860 | 264  |
| 198861 | 264  |
| 198863 | 264  |
| 198865 | 264  |
| 198870 | 265  |
| 198875 | 265  |
| 198876 | 265  |
| 198880 | 265  |
| 198882 | 265  |
| 198885 | 264  |
| 198892 | 261  |
| 198895 | 261  |
| 198900 | 151  |
| 198902 | 151  |
| 198904 | 151  |
| 198906 | 151  |
| 198915 | 252  |
| 198925 | 252  |
| 198946 | 155  |
| 198950 | 155  |
| 198955 | 155  |
| 198960 | 155  |
| 198965 | 155  |
| 198970 | 155  |
| 198975 | 155  |
| 198980 | 155  |
| 198981 | 155  |
| 198982 | 155  |
| 198983 | 155  |
| 198984 | 155  |
| 19     |      |

# www.alycotools.com

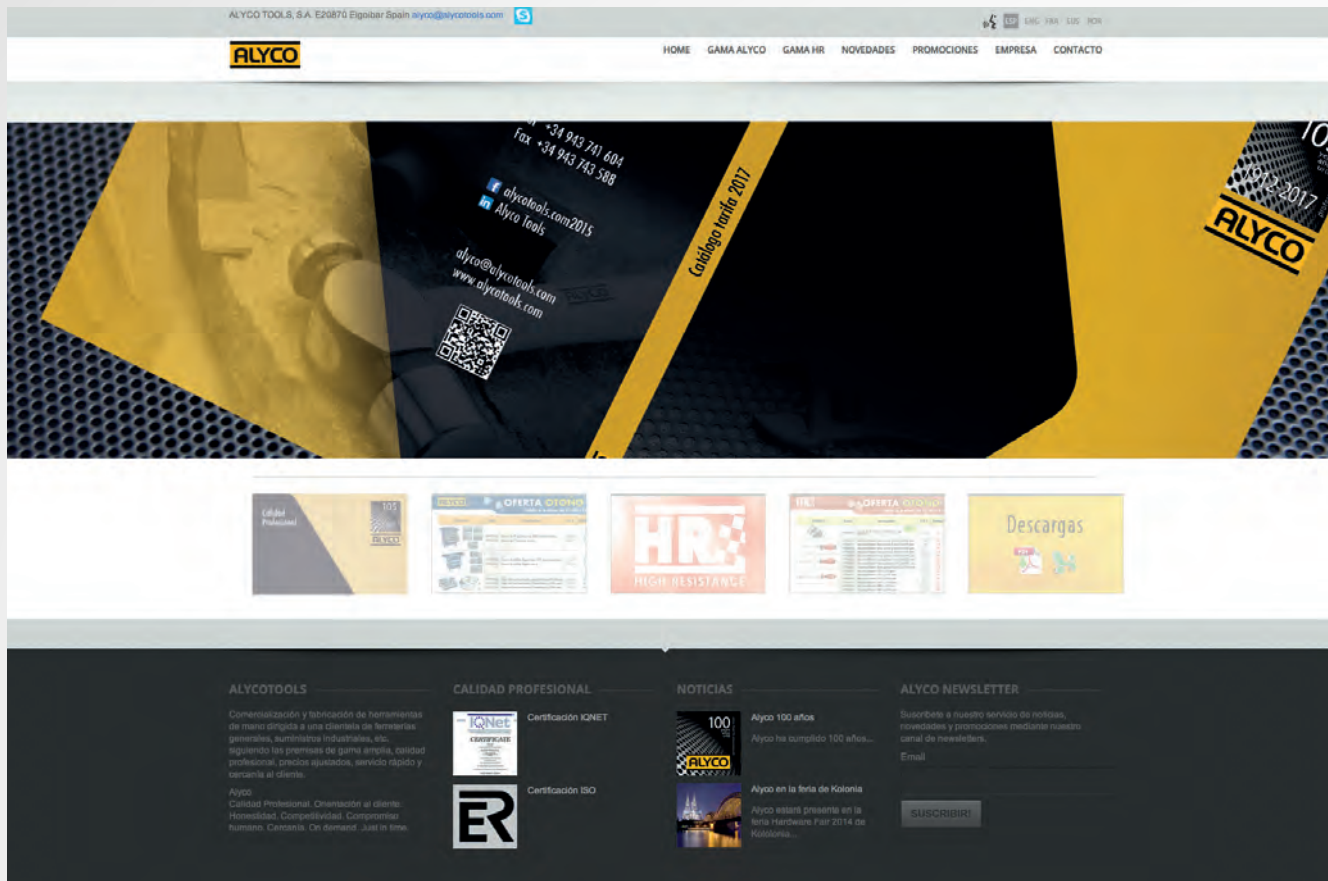

## INTERACTIVE CATALOGUE

Available from the website

Easy and quick way to check the catalogue

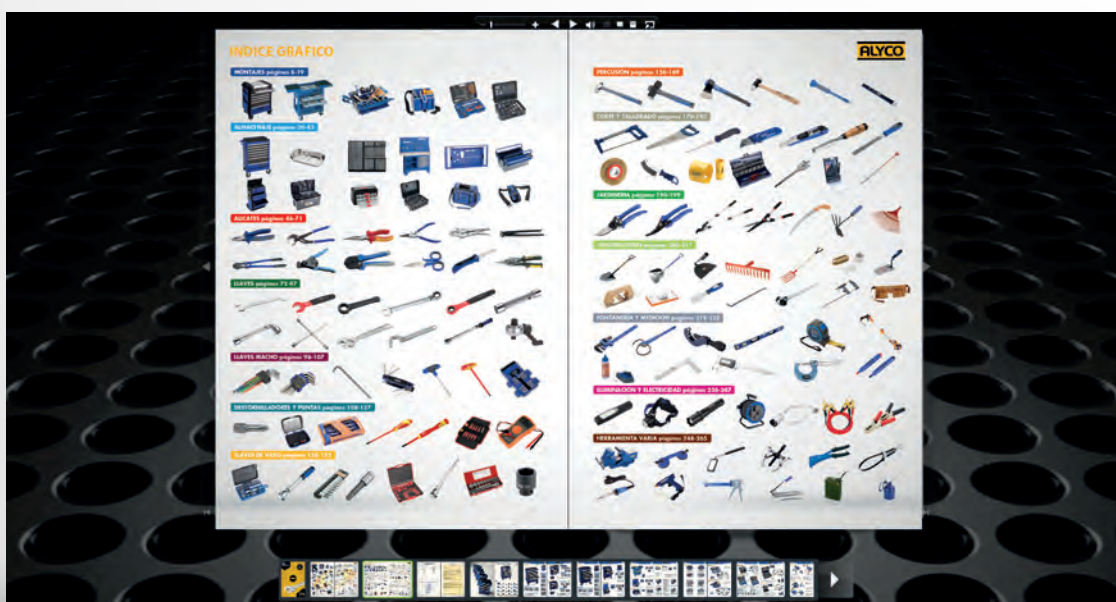

# FILE DOWLOAD POSSIBILITIES



Full Catalogue



Catalogue by chapters



Code, description, bar code in excel format



Season promotions



Bar code system

## GENERAL CONTACT



(34) 943 741 604



(34) 943 743 588



[alyco@alycotools.com](mailto:alyco@alycotools.com)



ALYCOTOOLS



[@alycotools.com2015](https://www.facebook.com/alycotools.com2015)



ALYCO TOOLS



Global Communication



Internacional Service



Quick Answer

# LOCATION OF THE COMPANY

San Lorenzo Industrial Area, 24 - 20870 ELGOIBAR - Basque Country - Spain



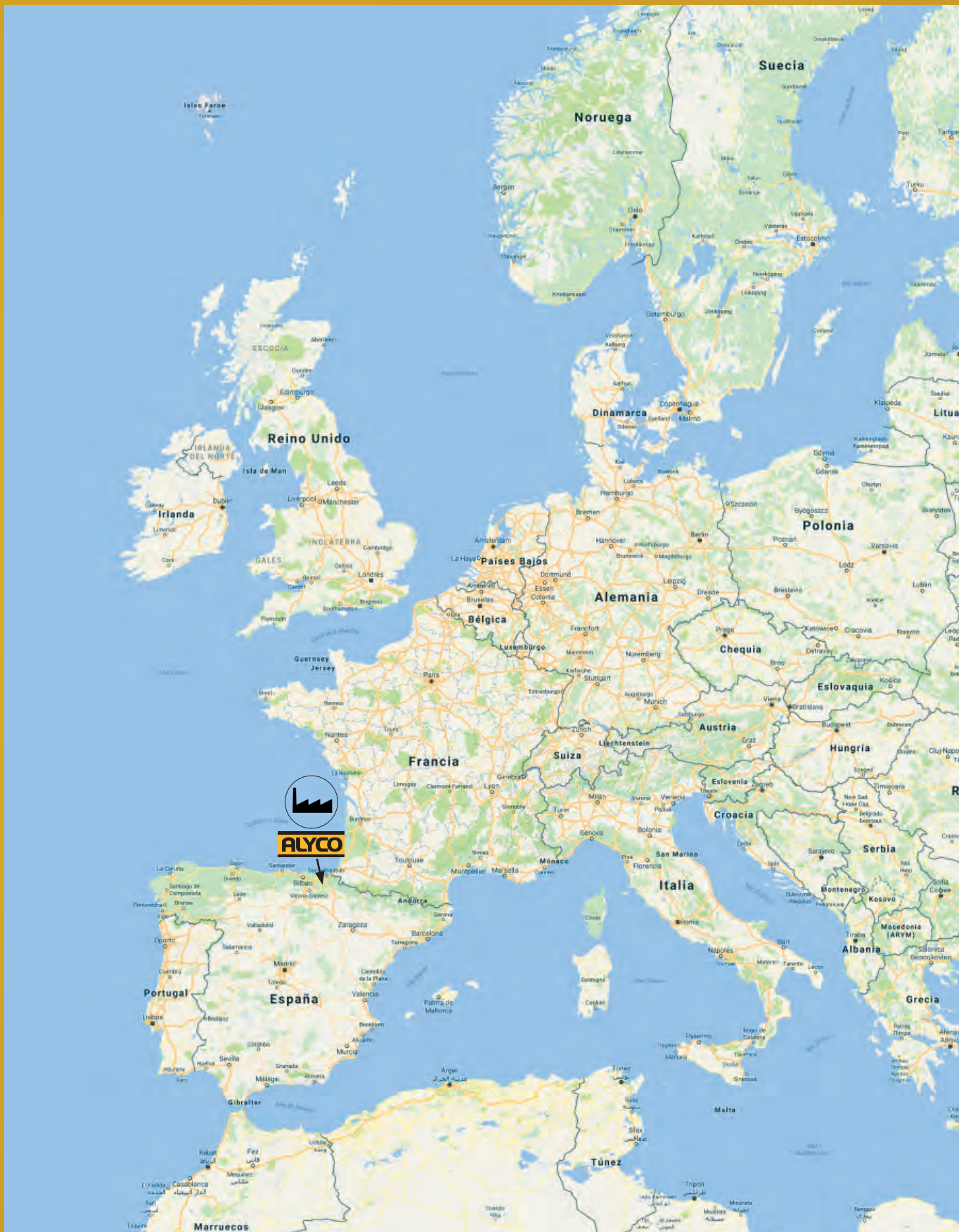

**SOCIAL ENGAGEMENT ALYCO WITH THE SPORT**







San Lorenzo  
Industrial Area, 24  
20870 Elgoibar (Spain)

Tel +34 943 741 604  
Fax +34 943 743 588

 [alycotools.com2015](https://www.facebook.com/alycotools.com2015)  
 [Alyco Tools](https://www.linkedin.com/company/alyco-tools)

[alyco@alycotools.com](mailto:alyco@alycotools.com)  
[www.alycotools.com](http://www.alycotools.com)

